

⚠️WARNING:

RECOGNIZE THIS SYMBOL AS AN INDICATION OF IMPORTANT SAFETY INFORMATION

⚠️WARNING

THESE INSTRUCTIONS ARE INTENDED AS AN AID TO QUALIFIED, LICENSED SERVICE PERSONNEL FOR PROPER INSTALLATION, ADJUSTMENT, AND OPERATION OF THIS UNIT. READ THESE INSTRUCTIONS THOROUGHLY BEFORE ATTEMPTING INSTALLATION OR OPERATION. FAILURE TO FOLLOW THESE INSTRUCTIONS MAY RESULT IN IMPROPER INSTALLATION, ADJUSTMENT, SERVICE, OR MAINTENANCE POSSIBLY RESULTING IN FIRE, ELECTRICAL SHOCK, PROPERTY DAMAGE, PERSONAL INJURY, OR DEATH.

Do not destroy this manual. Please read carefully and keep in a safe place for future reference by a serviceman.

[] indicates metric conversions.

92-104921-33-00 (/) Printed in USA

AIR COOLED CONDENSING UNITS

INSTALLATION INSTRUCTIONS

(-)A13NZ & (-)A14AZ MODEL SERIES -
13.4 & 14.3 SEER2

FEATURING INDUSTRY STANDARD
R-410A REFRIGERANT 

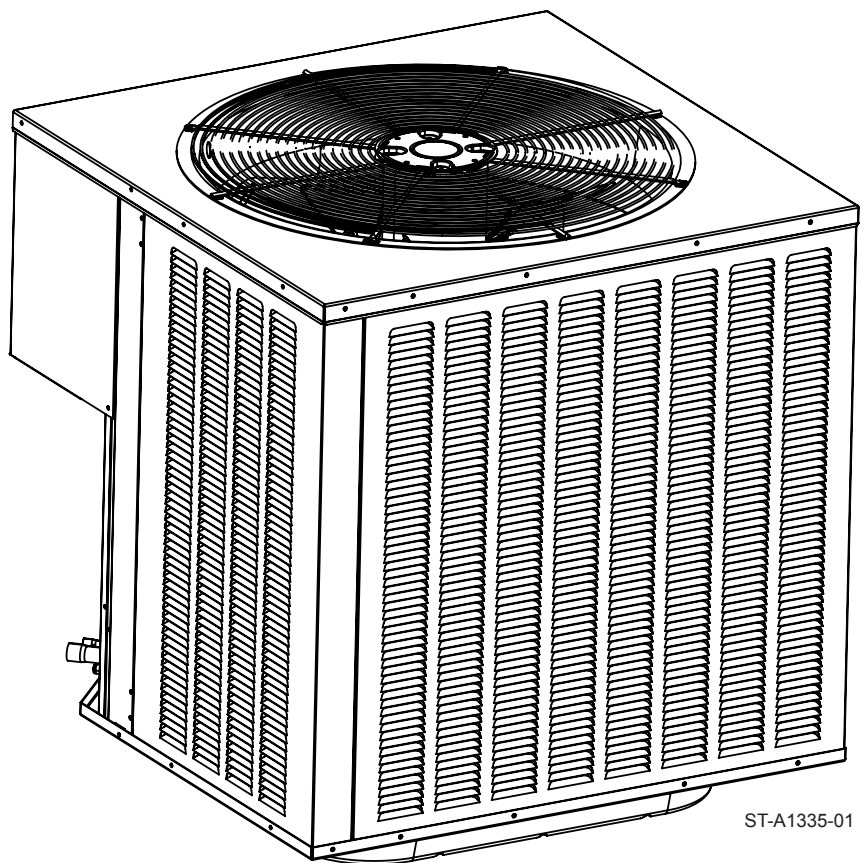

ST-A1335-01

NOTE: Actual unit appearance may vary.



CONTENTS

1.0 IMPORTANT SAFETY INFORMATION.....	3
2.0 GENERAL INFORMATION.....	4
2.1 Introduction.....	4
2.2 Importance of a Quality Installation.....	4
2.3 System Sizing and Selection.....	4
2.4 Importance of Proper Indoor/Outdoor Match-Ups.....	5
2.5 Checking Product Received.....	5
2.6 Efficiency Testing Notice.....	5
2.7 Compressor Break-In Notice.....	5
3.0 Unit Specifications.....	6
3.1 Model Number Nomenclature.....	6
3.2 Available Models.....	6
3.3 Electrical and Physical Data.....	7
4.0 Installation.....	9
4.1 Tools & Refrigerants.....	9
4.1.1 Tools Required for Installation & Servicing R-410A Models..	9
4.1.2 Specifications of R-410A.....	9
4.1.3 Quick Reference Guide for R-410A.....	9
4.2 Choosing a Location.....	10
4.2.1 Allowable Clearances.....	10
4.2.2 Operational Issue Related to Unit Location.....	10
4.2.3 Corrosive Environments.....	11
4.2.4 Customer Satisfaction Issues.....	11
4.3 Mounting Unit.....	11
4.3.1 Unit-Mounting Methods.....	11
4.3.2 High Wind and Seismic Tie-Down Methods.....	11
4.3.3 Elevating Unit.....	12
4.4 Refrigerant Line Set Selection.....	13
4.4.1 Replacing Existing System.....	13
4.4.2 Line Set Length and Fitting Losses.....	13
4.4.3 Liquid Line Selection.....	13
4.4.4 Suction Line Selection.....	16
4.4.5 Long Line Length Considerations.....	16
4.4.5.1 Determining if Long Line Set Length Requirements Apply..	16
4.4.5.2 Oil Return to Compressor.....	16
4.4.5.3 Refrigerant Migration During Off Cycle / Crankcase Heater.....	16
4.4.5.4 Maximum Liquid Pressure Drop.....	16
4.4.5.5 Liquid Line Refrigerant Flashing.....	16
4.4.5.6 Compressor Oil Level Adjustment for Long Line Set Applications.	17
4.4.5.7 Capacity Losses.....	17
4.5 Line Set Installation.....	18
4.5.1 Important Tubing Installation Practices.....	18
4.5.2 Relative Location of Indoor and Outdoor Units.....	19
4.5.2.1 Indoor and Outdoor Unit Near Same Level.....	19
4.5.2.2 Outdoor Unit Below Indoor Unit.....	20
4.5.2.3 Outdoor Unit Above Indoor Unit.....	21
4.5.3 Tubing Connections.....	22
4.6 Initial Leak Testing.....	23
4.7 Evacuation.....	23
4.8 Final Leak Testing.....	23
4.9 Control Wiring.....	24
4.10 Typical Control Wiring Connections.....	24
4.11 Power Wiring.....	25
4.12 Grounding.....	25
5.0 System Start-Up and Refrigerant Charging.....	26
5.1 System Start-Up Overview.....	26
5.2 Initial System Power Up.....	26

5.3 Verify Indoor Air-Flow.....	26
5.4 Refrigerant Charging.....	27
5.4.1 Measurement Device Set-Up.....	27
5.4.2 Preliminary Charging by Weight.....	27
5.4.3 Preliminary Charging by Pressures.....	28
5.4.4 Final Charging by Liquid Subcooling.....	28
5.4.5 R-410A Temperature Pressure Chart.....	29
5.5 Completing Installation.....	29
6.0 Sequence of Operation.....	29
7.0 Components & Controls.....	30
7.1 Compressor.....	30
7.2 Fan Motor.....	30
7.3 Outdoor Fan.....	30
7.4 Compressor Contactor.....	30
7.5 Compressor/Fan Motor Capacitor.....	30
7.6 Compressor Crankcase Heater.....	30
7.7 High and Low Pressure Control	31
7.8 Compressor Hand Start Components	31
8.0 Accessories.....	32
8.1 Compressor Time	32
8.2 High Pressure Control.....	32
8.3 Low Pressure Control	32
8.4 Low Ambient Control	32
8.5 Compressor Hard Start Kit	32
8.6 Compressor Crankcase Heater	32
8.7 Compressor Sound Enclosure.....	32
9.0 Diagnostics and Troubleshooting.....	33
9.1 Cooling Mechanical Checks Flowchart.....	33
9.2 General Troubleshooting Guide.....	34
9.3 Service Analyzer Charts.....	35
9.4 Troubleshooting Tips	40
10. Outdoor Unit Maintenance.....	41
10.1 Outdoor Coil Cleaning.....	41
10.2 Cabinet Cleaning and Care.....	41
10.3 Motor Lubrication.....	41
10.4 Replacement Parts.....	41
11.0 Wiring Diagrams.....	42
11.1 Single-Phase Models with PSC Motor	42
11.2 Single-Phase Models with ECM Motor	43

1.0 IMPORTANT SAFETY INFORMATION

⚠️ WARNINGS:

- These instructions are intended as an aid to qualified, licensed service personnel for proper installation, adjustment, and operation of this unit. Read these instructions thoroughly before attempting installation or operation. **Failure to follow these instructions may result in improper installation, adjustment, service, or maintenance possibly resulting in fire, electrical shock, property damage, personal injury, or death.**
- **The unit must be permanently grounded. Failure to do so can cause electrical shock resulting in severe personal injury or death.**
- **Turn off electric power at the fuse box or service panel before making any electrical connections.**
- **Complete the ground connection before making line voltage connections. Failure to do so can result in electrical shock, severe personal injury, or death.**
- **Disconnect all power to unit before starting maintenance. Failure to do so can cause electrical shock resulting in severe personal injury or death.**
- **Never assume the unit is properly wired and/or grounded. Always test the unit cabinet with a noncontact voltage detector available at most electrical supply houses or home centers before removing access panels or coming into contact with the unit cabinet.**
- **Do not use oxygen to purge lines or pressurize system for leak test. Oxygen reacts violently with oil, which can cause an explosion resulting in severe personal injury or death.**
- The top of the scroll compressor shell is hot. Touching the compressor top may result in serious personal injury.
- The manufacturer's warranty does not cover any damage or defect to the unit caused by the attachment or use of any components, accessories, or devices (other than those authorized by the manufacturer) into, onto, or in conjunction with the heat pump. **You should be aware that the use of unauthorized components, accessories, or devices may adversely affect the operation of the heat pump and may also endanger life and property.** The manufacturer disclaims any responsibility for such loss or injury resulting from the use of such unauthorized components, accessories, or devices.

⚠️ CAUTIONS:

- R-410A systems operate at approximately 60% higher pressures (1.6 times) than R-22 systems. Do not use R-22 service equipment or components on R-410A equipment. Use appropriate care when using this refrigerant. Failure to exercise care may result in equipment damage or personal injury.
- Only match this outdoor unit with a matched indoor coil or air handler approved for use with this outdoor unit per the unit manufacturer's specification sheet. The use of unmatched coils or air handler will likely result in a charge imbalance between the cooling and heating modes which can cause unsatisfactory operation including a high-pressure switch lockout condition.
- Only use indoor coils approved for use on R-410A systems. An R-22 coil will have a TXV or fixed restrictor device that is not designed to operate properly in an R-410A system and will result in serious operational issues. The R-22 coil could also contain mineral oil which is incompatible with the POE oil used in R-410A systems and could result in reliability issues with the compressor and TXVs.
- When coil is installed over a finished ceiling and/or living area, it is required that a secondary sheet metal condensate pan be constructed and installed under the entire unit. Failure to do so can result in property damage.
- The compressor has an internal overload protector. Under some conditions, it can take up to 2 hours for this overload to reset. Make sure overload has had time to reset before condemning the compressor.

⚠️ WARNING:

Single-pole contactors are used on all standard single-phase units through 5 tons. Caution must be exercised when servicing as only one leg of the power supply is broken by the contactor.

2.0 GENERAL INFORMATION

⚠WARNING:

Improper installation, or installation not made in accordance with these instructions, can result in unsatisfactory operation and/or dangerous conditions and can cause the related warranty not to apply.

2.1 Introduction

The information contained in this manual has been prepared to assist in the proper installation, operation, and maintenance of the air conditioning system.

Read this manual and any instructions packaged with separate equipment required to make up the system prior to installation. Homeowner should retain this manual for future reference.

2.2 Importance of Quality Installation

A quality installation is critical to assure safety, reliability, comfort, and customer satisfaction. Strict adherence to applicable codes, the information in this installation manual, the outdoor unit installation manual, and the thermostat installation manual are key to a quality installation. Read the entire instruction manuals before starting the installation.

IMPORTANT: This product has been designed and manufactured to meet certified AHRI capacity and efficiency ratings with the appropriate outdoor units. However, proper refrigerant charge, proper airflow, and refrigerant line sizing are critical to achieve optimum capacity and efficiency and to assure reliable operation. Installation of this product should follow the manufacturer's refrigerant charging and airflow instructions located in this installation manual and the charging chart label affixed to the outdoor unit. Failure to confirm proper charge and airflow may reduce energy efficiency and shorten equipment life.

The equipment has been evaluated in accordance with the Code of Federal Regulations, Chapter XX, Part 3280.

Install the unit in accordance with applicable national, state, and local codes. Latest editions are available from: "National Fire Protection Association, Inc., Batterymarch Park, Quincy, MA 02269." These publications are:

- ANSI/NFPA No. 70-(Latest Edition) National Electrical Code.

- NFPA90A Installation of Air Conditioning and Ventilating Systems.

- NFPA90B Installation of warm air heating and air conditioning systems.

Install the indoor unit in such a way as to allow necessary access to the coil/filter rack and blower/control compartment.

2.3 System Sizing and Selection

Before specifying any air-conditioning equipment, a survey of the structure and heat gain calculation must be made. A heat gain calculation involves identifying all surfaces and openings that gain heat from the surrounding air and quantifying that heat to determine the amount of heat that needs to be removed. A heat gain calculation also calculates the extra heat load caused by sunlight and for humidity removal. These factors must be considered before selecting an air-conditioning system to provide year-round comfort. The Air Conditioning Contractors of America (ACCA) Manual J method of load calculation is one recognized procedure for determining the cooling load.

After the proper equipment combination has been selected, satisfying both sensible and latent requirements, the system must be properly installed. Only then can the system provide the comfort it was designed to provide.

There are several factors that installers must consider.

- Outdoor unit location
- Indoor unit blower speed and airflow
- Proper equipment evacuation
- Supply and return air duct design and sizing
- Refrigerant charge
- System air balancing
- Diffuser and return air grille location and sizing

IMPORTANT: Excessive use of elbows in the refrigerant line set can produce excessive pressure drop. Follow industry best practices for installation. Installation and commissioning of this equipment is to be performed by trained and qualified HVAC professionals. For technical assistance, contact your Distributor Service Coordinator.

2.0 GENERAL INFORMATION

2.4 Importance of Proper Indoor/Outdoor Match-Ups

To assure many years of reliable operation and optimum customer comfort and to assure the outdoor unit warranty remains valid, an air-handler model or indoor coil/furnace combination should be selected that is properly matched to the outdoor unit. The recommended approach is to select an air-handler or indoor coil and gas furnace that has an AHRI match with the outdoor unit. Refer to the AHRI directory at www.ahridirectory.org to confirm the air-handler and outdoor unit are a certified combination in the AHRI Directory.

2.5 Checking Product Received

Upon receiving unit, inspect it for any shipping damage. Claims for damage, either apparent or concealed, should be filed immediately with the shipping company. Check model number, electrical characteristics, and accessories to determine if they are correct. Check system components (indoor coil, outdoor unit, air handler/furnace, etc.) to make sure they are properly matched.

2.6 Efficiency Testing Notice

For purposes of verifying or testing efficiency ratings, the test procedure in Title 10 APPENDIX M1 to Subpart B of Part 430 (Uniform Test Method for Measuring the Energy Consumption of Central Air Conditioners and Heat Pumps) and the clarifying provisions provided in the AHRI Operations Manual 210/240 that were applicable at the date of manufacture should be used for test set up and performance.

2.7 Compressor Break-In Notice

Prior to agency testing, the unit must be run for 20 hours at 115°F [46.1°C] outdoor ambient temperature with 80°F [26.7°C] dry bulb/75°F [23.9°C] wet bulb indoor ambient temperature to break the compressor in.

3.0 UNIT SPECIFICATIONS

3.1 Model Number Nomenclature

W A 14 A Z 18 A J 1 N A FGA

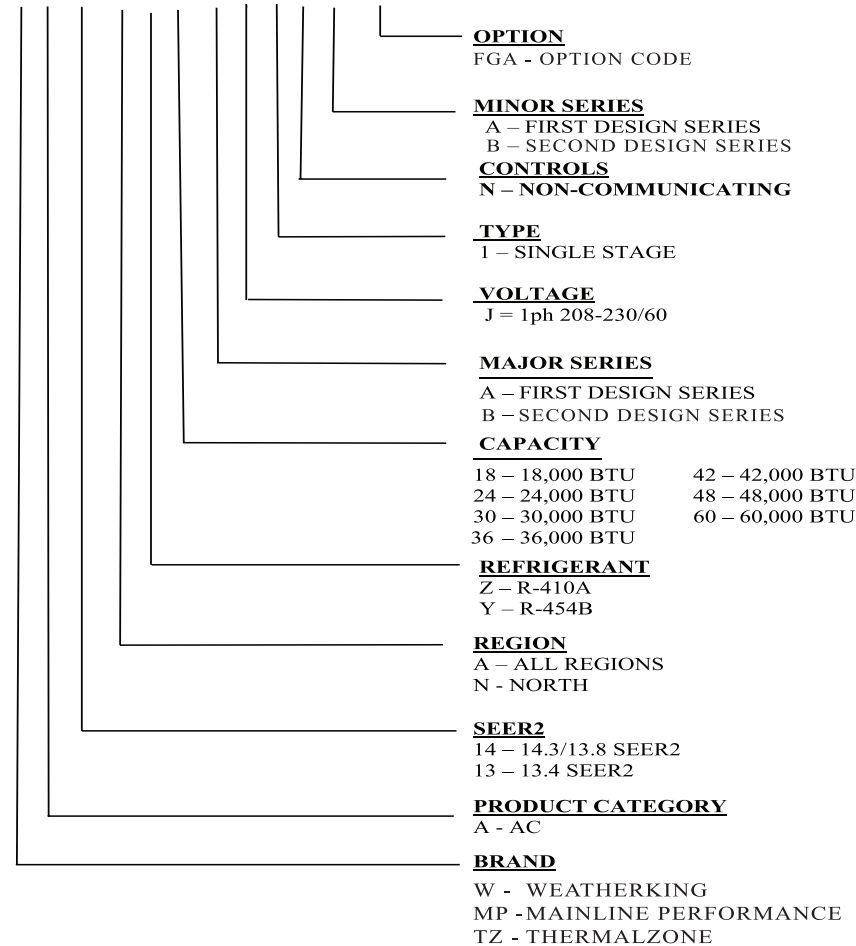

Specifications

3.2 Available Models

(-)A13NZ18AJ1NA	(-)A14AZ18AJ1NA
(-)A13NZ24AJ1NA	(-)A14AZ24AJ1NA
(-)A13NZ30AJ1NA	(-)A14AZ30AJ1NA
(-)A13NZ36AJ1NA	(-)A14AZ36AJ1NA
(-)A13NZ42AJ1NA	(-)A14AZ42AJ1NA
(-)A13NZ48AJ1NA	(-)A14AZ48AJ1NA
(-)A13NZ60AJ1NA	(-)A14AZ60AJ1NA

3.0 UNIT SPECIFICATIONS



3.3 Electrical and Physical Data

(-)A13NZ

Model Number	ELECTRICAL DATA										PHYSICAL DATA			
	Voltage	Phase	Freq	Compressor			Fan Motor Full Load Amperes (FLA)	Minimum Circuit Ampacity Amperes	Fuse or HACR Circuit Breaker		Outdoor Coil			Refrig. Per Circuit Oz. [g]
				MFR's Model Number	Rated Load Amperes (RLA)	Locked Rotor Amperes (LRA)			Minimum Amperes	Maximum Amperes	Face Area Sq. Ft. [m2]	No. Rows	CFM [L/s]	
(-)A13NZ18AJ1	208/230	1	60	ZP14K7E-PFV-130	9/9	42.6	0.8	12	15/15	20/20	10.9 [1.01]	1	1765 [833]	70 [1985]
				APH014KAA	6.8/6.8	41.7			15/15	15/15				
(-)A13NZ24AJ1	208/230	1	60	ZP20K7E-PFV-130	11.5/11.5	59.5	0.8	16	20/20	25/25	13.3 [1.24]	1	3439 [1623]	78 [2212]
				APH020KAA	9.3/9.3	49.7			15/15	15/15				
(-)A13NZ30AJ1	208/230	1	60	ZP25K7E-PFV-130	14.1/14.1	67.9	0.8	19	25/25	30/30	13.3 [1.24]	1	3439 [1623]	86 [2439]
				APH025KAA	11.7/11.7	71.3			20/20	25/25				
(-)A13NZ36AJ1	208/230	1	60	ZP31K7E-PFV-130	16/16	91.9	0.8	21	25/25	35/35	26.2 [2.43]	2	2957 [1396]	106 [3006]
				APH031KAA	13.1/13.1	83.1			25/25	30/30				
(-)A13NZ42AJ1	208/230	1	60	ZP36K7E-PFV-130	18.6/18.6	110	0.8	25	30/30	40/40	28.2 [2.62]	2	2830 [1336]	126 [3573]
				APH036KAA	15.9/15.9	95.2			25/25	35/35				
(-)A13NZ48AJ1	208/230	1	60	ZP42K7E-PFV-130	25/25	120	1	33	40/40	50/50	23.5 [2.18]	1	4095 [1933]	121 [3431]
				ABH042KAA	18.2/18.2	102.4			30/30	40/40				
(-)A13NZ60AJ1	208/230	1	60	ZP51K7E-PFV-130	25.6/25.6	150	1	34	40/40	50/50	28.4 [2.64]	1	4189 [1977]	186 [5274]
				ABH051KAA	23.9/23.9	124.5			40/40	50/50				

(-)A14AZ

Model Number	ELECTRICAL DATA										PHYSICAL DATA					
	Voltage	Phase	Freq	Compressor			Fan Motor Full Load Amperes (FLA)	Minimum Circuit Ampacity Amperes	Fuse or HACR Circuit Breaker		Outdoor Coil			Weight		
				MFR's Model Number	Rated Load Amperes (RLA)	Locked Rotor Amperes (LRA)			Minimum Amperes	Maximum Amperes	Face Area Sq. Ft. [m2]	No. Rows	CFM [L/s]	Refrig. Per Circuit Oz. [g]	Net Lbs. [kg]	Shipping Lbs. [kg]
(-)A14AZ18AJ1	208/230	1	60	ZP14K7E-PFV-130	9/9	42.6	0.8	12	15/15	20/20	21.4 [1.99]	2	2156 [1018]	94 [2665]	144 [65.3]	151 [68.5]
				APH014KAA	6.8/6.8	41.7			15/15	20/20						
(-)A14AZ24AJ1	208/230	1	60	ZP20K7E-PFV-130	11.5/11.5	59.5	0.8	16	20/20	25/25	26.2 [2.43]	2	2723 [1285]	115 [3260]	178 [80.7]	185 [83.9]
				APH020KAA	9.3/9.3	49.7			15/15	20/20						
(-)A14AZ30AJ1	208/230	1	60	ZP25K7E-PFV-130	14.1/14.1	67.9	0.8	19	25/25	30/30	28.2 [2.62]	2	2830 [1336]	120 [3402]	190 [86.2]	197 [89.4]
				APH025KAA	11.7/11.7	71.3			20/20	25/25						
(-)A14AZ36AJ1	208/230	1	60	ZP31K7E-PFV-130	16/16	91.9	0.8	21	25/25	35/35	25.6 [2.38]	1	3804 [1795]	118 [3345]	210 [95.3]	217 [98.4]
				APH031KAA	13.1/13.1	83.1			25/25	30/30						
(-)A14AZ42AJ1	208/230	1	60	ZP34K7E-PFV-130	17.7/17.7	110.2	1	24	30/30	40/40	38.3 [3.56]	2	3655 [1725]	149 [4224]	252 [114.3]	259 [117.5]
				APH034KAA	15.4/15.4	92.1			25/25	35/35						
(-)A14AZ48AJ1	208/230	1	60	ABH042KAA	18.2/18.2	102.4	1	24	30/30	40/40	38.3 [3.56]	2	3655 [1725]	153 [4337]	243 [110.2]	250 [113.4]
				ZP51K7E-PFV-130	25.6/25.6	150			35	45/45						
(-)A14AZ60AJ1	208/230	1	60	ZP51K7E-PFV-130	25.6/25.6	150	2.8	35	45/45	60/60	32.5 [3.02]	1	5178 [2444]	206 [5840]	287 [130.2]	294 [133.4]
				ABH051KAA	23.9/23.9	124.5			33	40/40						

3.0 UNIT SPECIFICATIONS



3.3 Electrical and Physical Data

DIMENSIONAL DATA

(-)A13NZ	18A	24A	30A	36A	42A	48A	60A
Height "H" inches [cm]	25.65 [65.15]	25.65 [65.15]	25.65 [65.15]	25.65 [65.15]	27.65 [70.23]	39.65 [100.71]	45.65 [115.95]
Length "L" inches [cm]	29.54 [75.03]	33.66 [85.49]	33.66 [85.49]	33.66 [85.49]	33.66 [85.49]	35.54 [90.28]	35.54 [90.28]
Width "W" inches [cm]	29.54 [75.03]	33.66 [85.49]	33.66 [85.49]	33.66 [85.49]	33.66 [85.49]	35.54 [90.28]	35.54 [90.28]

(-)A14AZ	18A	24A	30A	36A	42A	48A	60A
Height "H" inches [cm]	25.65 [65.15]	25.65 [65.15]	27.65 [70.23]	31.65 [80.39]	35.65 [90.55]	35.65 [90.55]	51.65 [131.19]
Length "L" inches [cm]	29.54 [75.03]	33.66 [85.49]	33.66 [85.49]	33.66 [85.49]	33.66 [85.49]	33.66 [85.49]	35.54 [90.27]
Width "W" inches [cm]	29.54 [75.03]	33.66 [85.49]	33.66 [85.49]	33.66 [85.49]	33.66 [85.49]	33.66 [85.49]	35.54 [90.27]

Specifications

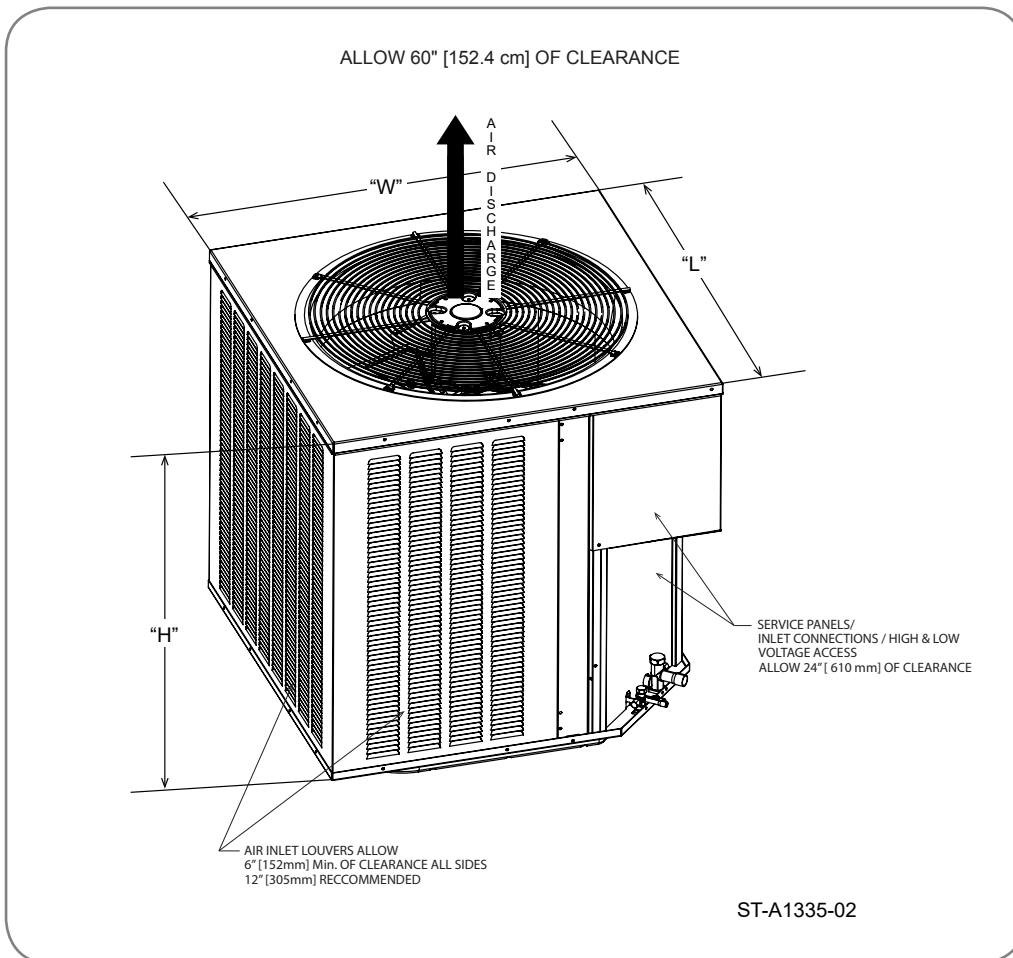

NOTE: Actual unit appearance may vary.

4.0 INSTALLATION



4.1 Tools and Refrigerant

4.1.1 Tools Required for Installing and Servicing R-410A Models

Manifold Sets:

- Up to 800 PSIG [5,516 kPa] High-Side
- Up to 250 PSIG [1,724 kPa] Low-Side
- 550 PSIG [3,792 kPa] Low-Side Retard

Manifold Hoses:

- Service Pressure Rating of 800 PSIG [5,516 kPa]

Recovery Cylinders:

- 400 PSIG [2,758 kPa] Pressure Rating
- Dept. of Transportation 4BA400 or BW400

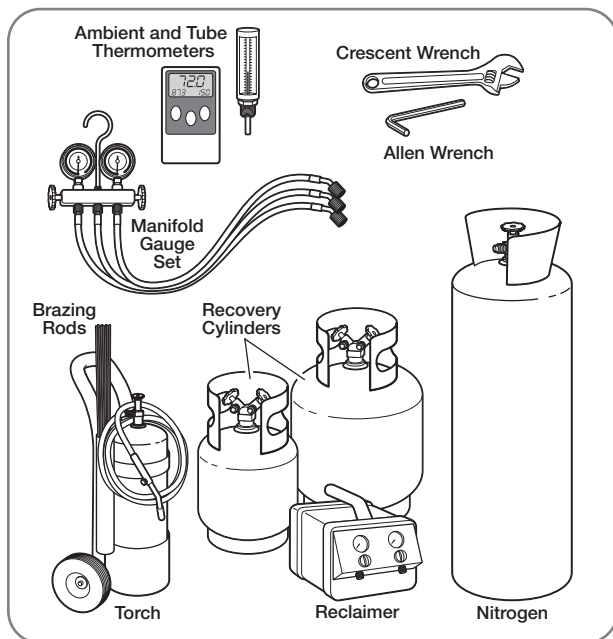

CAUTION: R-410A systems operate at higher pressures than R-22 systems. Do not use R-22 service equipment or components on R-410A equipment.

4.1.2 Specifications of R-410A

Application: R-410A is not a drop-in replacement for R-22. Equipment designs must accommodate its higher pressures. It cannot be retrofitted into R-22 heat pumps.

Physical Properties: R-410A has an atmospheric boiling point of -62.9°F [-52.7°C] and its saturation pressure at 77°F [25°C] is 224.5 psig [1,548 kPa].

Composition: R-410A is a near-azeotropic mixture of 50% by weight difluoromethane (HFC-32) and 50% by weight pentafluoroethane (HFC-125).

Pressure: The pressure of R-410A is approximately 60% (1.6 times) greater than R-22. Recovery and recycle equipment, pumps, hoses, and the like must have design pressure ratings appropriate for R-410A. *Manifold sets need to range up to 800 psig [5,516 kPa] high-side and 250 psig [1,724 kPa] low-side with a 550 psig [3,792 kPa] low-side retard. Hoses need to have a service pressure rating of 800 psig [5,516 kPa]. Recovery cylinders need to have a 400 psig [2,758 kPa] service pressure rating, DOT 4BA400 or DOT BW400.*

Combustibility: At pressures above 1 atmosphere, a mixture of R-410A and air can become combustible. **R-410A and air should never be mixed in tanks or supply lines or be allowed to accumulate in storage tanks. Leak checking should never be done with a mixture of R-410A and air.** Leak-checking can be performed safely with nitrogen or a mixture of R-410A and nitrogen.

4.1.3 Quick-Reference Guide for R-410A

- R-410A refrigerant operates at approximately 60% higher pressure (1.6 times) than R-22. Ensure that servicing equipment is designed to operate with R-410A.
- R-410A refrigerant cylinders are light rose in color.
- R-410A, as with other HFCs, is only compatible with POE oils.
- Vacuum pumps will not remove moisture from POE oil used in R-410A systems.
- R-410A systems are to be charged with liquid refrigerants. Prior to March 1999, R-410A refrigerant cylinders had a dip tube. These cylinders should be kept upright for equipment charging. Post-March 1999 cylinders do not have a dip tube and should be inverted to ensure liquid charging of the equipment.
- Do not install a suction line filter drier in the liquid line.
- A factory-approved bi-flow liquid line filter drier is shipped with every unit and must be installed in the liquid line at the time of installation. Only manufacturer-approved liquid line filter driers should be used. Filter driers must have a minimum working pressure rating of at least 600 psig [4,137 kPa]. The filter drier will only have adequate moisture-holding capacity if the system is properly evacuated.
- Desiccant (drying agent) must be compatible for POE oils and R-410A refrigerant.

4.0 INSTALLATION



4.2 Choosing a Location

4.2.1 Allowable Clearances

- 12" [30.5 cm] to side intake louvers
- 24" [61.0 cm] to service access panels
- 60" [152.4 cm] vertical for fan discharge

If space limitations exist, the following clearances will have minimal impact to capacity and efficiency and are permitted:

Single-Unit Applications: Minimum of 6" [15.2 cm] to side intake louvers. Do not reduce the 60" [152.4 cm] for fan discharge or the 24" [61.0 cm] service clearances.

Multiple-Unit Applications: For units positioned next to each other, a minimum of 6" [15.2 cm] clearance between units is recommended for 1.5 and 2 ton models and 9" [22.9 cm] for 2.5 ton to 5 ton models. Do not reduce the 60" [152.4 cm] for fan discharge or the 24" [61.0 cm] service clearances.

IMPORTANT: Consult local and national building codes and ordinances for special installation requirements. Following location information will provide longer life and simplified servicing of the outdoor unit.

NOTICE: These units must be installed outdoors. No ductwork can be attached, or other modifications made, to the discharge grille. Modifications will affect performance or operation.

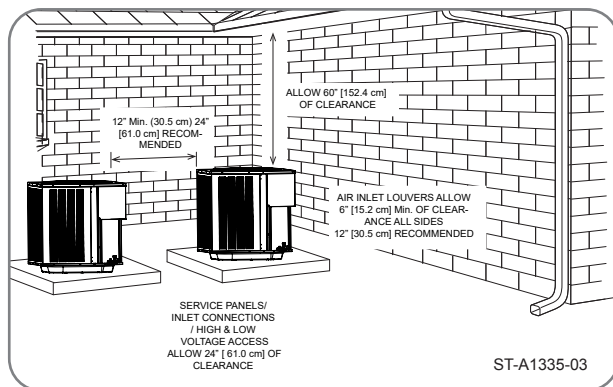

4.2.2 Operational Issues Related to Unit Location

IMPORTANT: Locate the unit in a manner that will not prevent, impair, or compromise the performance of other equipment installed in proximity to the unit. Maintain all required minimum distances to gas and electric meters, dryer vents, and exhaust and inlet openings. In the absence of national codes or manufacturers' recommendations, local code recommendations and requirements will take precedence.

- Refrigerant piping and wiring should be properly sized and kept as short as possible to avoid capacity losses and increased operating costs.
- Locate the unit where water runoff will not create a problem with the equipment. Position the unit away from the drip edge of the roof whenever possible. Units are weatherized, but can be affected by the following:
- Water pouring into the unit from the junction of rooflines, without protective guttering. Large volumes of water entering the unit while in operation can impact fan blade or motor life.
- Closely follow the clearance recommendations in section 4.2.1.
 - 24" [61.0 cm] to the service panel access
 - 60" [152.4 cm] above fan discharge (unit top) to prevent recirculation
 - 6" [15.2 cm] to coil grille air inlets with 12" [30.5 cm] minimum recommended

4.0 INSTALLATION



4.2 Choosing a Location (cont.)

4.2.3 Corrosive Environment

The metal parts of this unit may be subject to rust or deterioration if exposed to a corrosive environment. This oxidation could shorten the equipment's useful life.

Corrosive elements include, but are not limited to, salt spray, fog or mist in seacoast areas, sulphur or chlorine from lawn watering systems, and various chemical contaminants from industries such as paper mills and petroleum refineries.

If the unit is to be installed in an area where contaminants are likely to be a problem, special attention should be given to the equipment location and exposure.

- Avoid having lawn sprinkler heads spray directly on the unit cabinet.
- In coastal areas, locate the unit on the side of the building away from the waterfront.
- Shielding provided by a fence or shrubs may give some protection, but cannot violate minimum airflow and service access clearances.

⚠ WARNING: Disconnect all power to unit before starting maintenance. Failure to do so can cause electrical shock resulting in severe personal injury or death.

Regular maintenance will reduce the buildup of contaminants and help to protect the unit's finish.

- Frequent washing of the cabinet, fan blade, and coil with fresh water will remove most of the salt or other contaminants that build up on the unit.
- Regular cleaning and waxing of the cabinet with a good automobile polish will provide some protection.
- A good liquid cleaner may be used several times a year to remove matter that will not wash off with water.

4.2.4 Customer Satisfaction Issues

- The outdoor unit should be located away from the living, sleeping, and recreational spaces of the owner and those spaces on adjoining property.
- To prevent noise transmission, the mounting pad for the outdoor unit should not be connected to the structure and should be located a sufficient distance above grade to prevent ground water from entering the unit.



4.3 Mounting Unit

4.3.1 Unit Mounting Methods

The outdoor unit may be mounted in a number of ways. The most common method is on a ground mounted concrete or pre-fabricated pad. It can also be mounted on a ground or roof mounted metal frame, wooden frame, or 4" x 4" [10.2 cm x 10.2 cm] wooden stringers. It is extremely important to properly secure the unit to the pad or frame so it does not shift during high winds, seismic events, or other outside forces to eliminate the possibility of a safety hazard or physical damage to the unit. Local codes in regions subject to frequent hurricanes and seismic events will dictate specific mounting requirements and must be followed.

4.3.2 High Wind and Seismic Tie-Down Methods

The manufacturer-approved/recommended method is a guide to securing equipment for wind and seismic loads. Other methods might provide the same result, but the manufacturer method is the only one endorsed by the manufacturer for securing equipment where wind or earthquake damage can occur. Additional information is available on the manufacturer's website or from the wholesale distributor.

4.0 INSTALLATION

4.3.3 Elevating Unit

⚠ WARNING: Secure an elevated unit and its elevating stand in order to prevent tipping. Failure to do so may result in severe personal injury or death.

If elevating the unit, either on a flat roof or on a slab, observe the following guidelines.

- The bottom of the basepan has receptacles for 4" [10.2 cm] schedule 40 PVC pipe that can be cut to length and used as risers for slab applications.
- If elevating a unit on a flat roof, use 4" x 4" [10.2 cm x 10.2 cm] or equivalent stringers positioned to distribute unit weight evenly and prevent noise and vibration.

NOTICE: Do not block drain openings on bottom of unit.

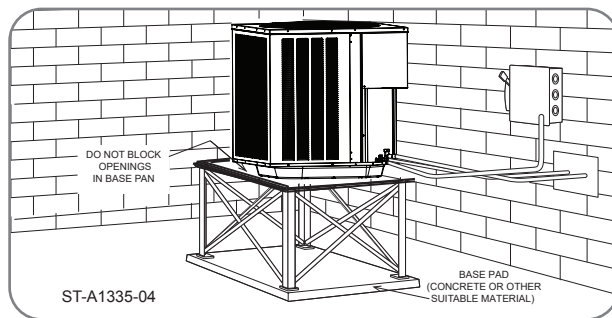

4.0 INSTALLATION



4.4 Refrigerant Line Set Selection

4.4.1 Replacing Existing Systems

To prevent failure of a new unit, the existing line set must be correctly sized for the new unit and must be cleaned or replaced. Care must be taken so the expansion device is not plugged. For new and replacement units, a liquid line filter drier must be installed and the line set must be properly sized. Test the oil for acid. If it tests positive for acid, a suction line filter drier is mandatory.

IMPORTANT: When replacing an R-22 unit with an R-410A unit, either replace the line set or ensure that residual mineral oil is drained from existing lines including oil trapped in low spots.

4.4.2 Line Set Length and Fitting Losses

Refrigerant tubing is measured in terms of actual length and equivalent length. Actual length is used for refrigerant charge applications. Equivalent length takes into account pressure losses from

tubing length, fittings, vertical separation, accessories, and filter driers. The table below references commonly used equivalent lengths.

Table 1

Equivalent Length for Fittings (ft) [m]							
Line Size (in) [mm]	90° Short Radius Elbow	90° Long Radius Elbow	45° Elbow	Solenoid Valve	Check Valve	Site Glass	Filter Drier
3/8 [9.53]	1.3 [0.40]	0.8 [0.24]	0.3 [0.09]	6 [1.83]	4 [1.22]	0.4 [0.12]	6 [1.83]
1/2 [12.71]	1.4 [0.43]	0.9 [0.27]	0.4 [0.12]	9 [2.74]	5 [1.52]	0.6 [0.18]	6 [1.83]
5/8 [15.88]	1.5 [0.46]	1 [0.30]	0.5 [0.15]	12 [3.66]	6 [1.83]	0.8 [0.24]	6 [1.83]
3/4 [19.05]	1.9 [0.58]	1.3 [0.40]	0.6 [0.18]	14 [4.27]	7 [2.13]	0.9 [0.27]	6 [1.83]
7/8 [22.23]	2.3 [0.70]	1.5 [0.46]	0.7 [0.21]	15 [4.57]	8 [2.44]	1 [0.30]	6 [1.83]
1-1/8 [28.58]	2.7 [0.82]	1.8 [0.55]	0.9 [0.27]	22 [6.71]	12 [3.66]	1.5 [0.46]	6 [1.83]

4.4.3 Liquid Line Selection

The purpose of the liquid line is to transport warm sub-cooled liquid refrigerant between the outdoor unit to the indoor unit. It is important not to allow the refrigerant to flash into superheated vapor prior to the expansion device of the indoor coil. The flashing of refrigerant can occur for the following reasons:

- Low refrigerant charge
- Improperly selected liquid line size
- Absorption of heat prior to expansion device
- Excessive vertical separation between the outdoor unit and indoor coil
- Restricted liquid line or filter drier
- Kinked liquid line

The total pressure drop allowed for the liquid line is 50 PSI [345 kPa]. The procedure for selecting the proper liquid line is as follows:

- Measure the total amount of vertical separation between the outdoor unit and indoor coil.
- Measure the linear length of liquid line needed.
- Add all of the equivalent lengths associated with any fittings or accessories using Table 1 above.
- Add the linear length to the total fitting equivalent length. This will equal your total equivalent line length.
- Reference Table 2 to verify the calculated equivalent length is acceptable with the required vertical separation and diameter of liquid line.

4.0 INSTALLATION



4.4 Refrigerant Line Set Selection (cont.)

Table 2A: Refrigerant Line Sizing Chart (English Units)

13.4 - 14.3 SEER2 Single-Stage Air-Conditioners														
Unit Size	Allowable Liquid Line Size	Allowable Suction Line Size	Apply Long Line Guidelines if Linear Line Length Exceeds Those Shown		Equivalent Length (Feet)									
			(-) A13NZ	(-) A14AZ	<25	26-50	51-75	76-100	101-125	126-150	151-175	176-200	201-225	226-250
					Maximum Vertical Rise (Outdoor Unit Below Indoor Unit) * / Capacity Multiplier									
1.5 Ton ** SEE NOTE 3	1/4"	5/8"	/	/	25 / 100	50 / 0.99	62 / 0.98	43 / 0.98	24 / 0.97	5 / 0.97	NR	NR	NR	NR
	5/16"	5/8"	/	223	25 / 100	50 / 0.99	75 / 0.98	98 / 0.98	93 / 0.97	88 / 0.97	83 / 0.96	78 / 0.96	73 / 0.95	68 / 0.94
	3/8"	5/8"	178	148	25 / 100	50 / 0.99	75 / 0.98	100 / 0.98	100 / 0.97	100 / 0.97	100 /	100 / 0.96	100 / 0.95	100 /
	1/4"	3/4" **	/	/	25 / 100	50 / 1.00	62 / 0.99	43 / 0.99	24 / 0.99	5 / 0.99	NR	NR	NR	NR
	5/16"	3/4" **	/	223	25 / 100	50 / 1.00	75 / 0.99	98 / 0.99	93 / 0.99	88 / 0.99	83 / 0.99	78 / 0.98	73 / 0.98	68 / 0.98
	3/8"	3/4" **	178	148	25 / 100	50 / 1.00	75 / 1.00	100 / 0.99	100 /	100 /	100 /	100 / 0.98	100 / 0.98	100 /
2 Ton	1/4"	5/8"	/	/	25 / 0.99	50 / 0.98	21 / 0.97	NR	NR	NR	NR	NR	NR	NR
	5/16"	5/8"	213	213	25 / 0.99	50 / 0.98	75 / 0.97	87 / 0.96	77 / 0.95	69 / 0.94	61 / 0.93	53 / 0.92	45 / 0.91	37 / 0.90
	3/8"	5/8"	142	142	25 / 0.99	50 / 0.98	75 / 0.97	100 / 0.96	100 / 0.95	100 /	98 / 0.93	95 / 0.92	92 / 0.91	89 / 0.90
	1/4"	3/4"	/	/	25 / 1.00	50 / 1.00	21 / 0.99	NR	NR	NR	NR	NR	NR	NR
	5/16"	3/4"	213	213	25 / 1.00	50 / 1.00	75 / 0.99	87 / 0.99	77 / 0.98	69 / 0.98	61 / 0.98	53 / 0.97	45 / 0.97	37 / 0.96
	3/8"	3/4"	142	142	25 / 1.00	50 / 1.00	75 / 0.99	100 / 0.99	100 /	100 /	98 / 0.98	95 / 0.97	93 / 0.97	90 / 0.96
2.5 Ton	5/16"	5/8"	n/a	n/a	25 / 0.99	50 / 0.98	75 / 0.96	70 / 0.94	59 / 0.93	48 / 0.91	36 / 0.90	NR	NR	NR
	3/8"	5/8"	142	117	25 / 0.99	50 / 0.98	75 / 0.96	100 / 0.94	98 / 0.93	94 / 0.91	90 / 0.90	NR	NR	NR
	5/16"	3/4"	213	175	25 / 1.00	50 / 0.99	75 / 0.99	70 / 0.98	59 / 0.98	48 / 0.97	36 / 0.96	25 / 0.96	13 / 0.95	NR
	3/8"	3/4"	142	117	25 / 1.00	50 / 0.99	75 / 0.99	100 / 0.98	98 / 0.98	94 / 0.97	90 / 0.96	86 / 0.96	82 / 0.95	78 / 0.95
	5/16"	5/8"	n/a	n/a	25 / 0.99	50 / 0.97	66 / 0.94	49 / 0.92	32 / 0.90	NR	NR	NR	NR	NR
	3/8"	5/8"	108	85	25 / 0.99	50 / 0.97	75 / 0.94	95 / 0.92	89 / 0.90	NR	NR	NR	NR	NR
3 Ton	5/16"	3/4"	n/a	128	25 / 1.00	50 / 0.99	66 / 0.98	49 / 0.98	32 / 0.97	15 / 0.96	NR	NR	NR	NR
	3/8"	3/4"	108	85	25 / 1.00	50 / 0.99	75 / 0.98	95 / 0.98	89 / 0.97	84 / 0.96	78 / 0.95	72 / 0.94	67 / 0.93	61 / 0.93
	1/2"	3/4"	54	43	25 / 1.00	50 / 0.99	75 / 0.98	100 / 0.98	100 / 0.97	100 /	100 / 0.95	100 / 0.94	100 / 0.93	100 /
	5/16"	7/8"	n/a	128	25 / 1.00	50 / 1.00	66 / 1.00	49 / 0.99	32 / 0.99	15 / 0.99	NR	NR	NR	NR
	3/8"	7/8"	108	85	25 / 1.00	50 / 1.00	75 / 1.00	95 / 0.99	89 / 0.99	84 / 0.99	78 / 0.98	72 / 0.98	67 / 0.98	61 / 0.97
	1/2"	7/8"	54	43	25 / 1.00	50 / 1.00	75 / 1.00	100 / 0.99	100 /	100 /	100 /	100 / 0.98	100 / 0.98	100 / 0.97
3.5 Ton	3/8"	3/4"	150	102	25 / 0.99	50 / 0.98	75 / 0.97	88 / 0.96	80 / 0.95	72 / 0.94	65 / 0.92	57 / 0.91	49 / 0.90	NR
	1/2"	3/4"	75	51	25 / 0.99	50 / 0.98	75 / 0.97	100 / 0.96	100 / 0.95	100 /	100 /	100 / 0.91	100 / 0.90	NR
	3/8"	7/8"	150	102	25 / 1.00	50 / 1.00	75 / 0.99	88 / 0.99	80 / 0.99	72 / 0.98	65 / 0.97	57 / 0.97	49 / 0.96	42 / 0.96
	1/2"	7/8"	75	51	25 / 1.00	50 / 1.00	75 / 0.99	100 / 0.99	100 /	100 /	100 / 0.97	100 / 0.97	100 / 0.96	100 /
	3/8"	3/4"	148	110	25 / 0.99	50 / 0.98	75 / 0.96	77 / 0.95	67 / 0.93	57 / 0.92	46 / 0.91	NR	NR	NR
	1/2"	3/4"	74	55	25 / 0.99	50 / 0.98	75 / 0.96	100 / 0.95	100 /	100 /	100 / 0.91	NR	NR	NR
4 Ton	3/8"	7/8"	148	110	25 / 1.00	50 / 0.99	75 / 0.99	77 / 0.98	67 / 0.97	57 / 0.97	46 / 0.96	36 / 0.96	26 / 0.95	15 / 0.95
	1/2"	7/8"	74	55	25 / 1.00	50 / 0.99	75 / 0.99	100 / 0.98	100 / 0.97	100 / 0.97	100 /	100 / 0.96	99 / 0.95	97 / 0.95
	3/8"	3/4"	78	0	25 / 0.99	50 / 0.97	75 / 0.94	61 / 0.92	46 / 0.90	NR	NR	NR	NR	NR
	1/2"	3/4"	39	0	25 / 0.99	50 / 0.97	75 / 0.94	100 / 0.92	100 /	NR	NR	NR	NR	NR
	3/8"	7/8"	78	0	25 / 1.00	50 / 0.99	75 / 0.98	61 / 0.97	46 / 0.96	32 / 0.95	18 / 0.94	NR	NR	NR
	1/2"	7/8"	39	0	25 / 1.00	50 / 0.99	75 / 0.98	100 / 0.97	100 / 0.96	100 / 0.95	97 / 0.94	95 / 0.94	92 / 0.93	89 / 0.92
5 Ton	3/8"	1-1/8"	78	0	25 / 1.01	50 / 1.01	75 / 1.00	61 / 1.00	46 / 0.99	32 / 0.99	18 / 0.99	NR	NR	NR
	1/2"	1-1/8"	39	0	25 / 1.01	50 / 1.01	75 / 1.00	100 / 1.00	100 /	100 /	97 / 0.99	95 / 0.99	92 / 0.99	89 / 0.98

Notes:

- 1) Do not exceed 200 ft linear line length.
- 2) * Do not exceed 180 ft vertical separation if outdoor unit is above indoor unit.
- 3) ** 3/4" suction line should only be used for 1.5 ton systems if outdoor unit is below or at same level as indoor to assure proper oil return.
- 4) Always use the smallest liquid line allowable to minimize refrigerant charge.
- 5) Applications shaded in light gray indicate capacity multipliers between 0.90 and 0.96 which are not recommended, but are allowed.
- 6) Applications shaded in dark gray are not recommended due to excessive liquid or suction pressure drop.

4.0 INSTALLATION



4.5 Refrigerant Line Set Selection (cont.)

Table 2B: Refrigerant Line Sizing Chart (Metric Units)

13.4 - 14.3 SEER2 Single-Stage Air-Conditioners														
Unit size	Allowable Liquid Line Size mm [in.]	Allowable Suction Line Size mm [in.]	Apply Long Line Guidelines if Linear Line Length Exceeds Those		Equivalent Length (Meters)									
			(-)A13NZ	(-)A14AZ	8	8 15	16 23	24 30	31 38	39 46	47 53	54 61	62 69	70 76
					Maximum Vertical Rise (Outdoor Unit Below Indoor Unit) * / Capacity Multiplier									
5.3 KW [1.5 Ton] **SEE NOTE 3	6.35 [1/4]	15.88 [5/8]	n/a	n/a	8 / 1.00	15 / 0.99	19 / 0.98	13 / 0.98	7 / 0.97	2 / 0.97	NR	NR	NR	NR
	7.94 [5/16]	15.88 [5/8]	n/a	68	8 / 1.00	15 / 0.99	23 / 0.98	30 / 0.98	28 / 0.97	27 / 0.97	25 / 0.96	24 / 0.96	22 / 0.95	21 / 0.94
	9.53 [3/8]	15.88 [5/8]	54	45	8 / 1.00	15 / 0.99	23 / 0.98	30 / 0.98	30 / 0.97	30 / 0.97	30 / 0.96	30 / 0.96	30 / 0.95	30 / 0.94
	6.35 [1/4]	19.05 [3/4]	n/a	n/a	8 / 1.00	15 / 1.00	19 / 0.99	13 / 0.99	7 / 0.99	2 / 0.99	NR	NR	NR	NR
	7.94 [5/16]	19.05 [3/4]	n/a	68	8 / 1.00	15 / 1.00	23 / 0.99	30 / 0.99	28 / 0.99	27 / 0.99	25 / 0.99	24 / 0.98	22 / 0.98	21 / 0.98
7.0 KW [2 Ton]	6.35 [1/4]	15.88 [5/8]	n/a	n/a	8 / 0.99	15 / 0.98	6 / 0.97	NR	NR	NR	NR	NR	NR	NR
	7.94 [5/16]	15.88 [5/8]	65	59	8 / 0.99	15 / 0.98	23 / 0.97	27 / 0.96	23 / 0.95	21 / 0.94	19 / 0.93	16 / 0.92	14 / 0.91	11 / 0.90
	9.53 [3/8]	15.88 [5/8]	43	39	8 / 0.99	15 / 0.98	23 / 0.97	30 / 0.96	30 / 0.95	30 / 0.94	30 / 0.93	29 / 0.92	28 / 0.91	27 / 0.90
	6.35 [1/4]	19.05 [3/4]	n/a	n/a	8 / 1.00	15 / 1.00	6 / 0.99	NR	NR	NR	NR	NR	NR	NR
	7.94 [5/16]	19.05 [3/4]	65	59	8 / 1.00	15 / 1.00	23 / 0.99	27 / 0.99	23 / 0.98	21 / 0.98	19 / 0.98	16 / 0.97	14 / 0.97	11 / 0.96
8.8 KW [2.5 Ton]	6.35 [1/4]	19.05 [3/4]	43	39	8 / 1.00	15 / 1.00	23 / 0.99	30 / 0.99	30 / 0.98	30 / 0.98	30 / 0.98	29 / 0.97	28 / 0.97	27 / 0.96
	7.94 [5/16]	15.88 [5/8]	n/a	n/a	8 / 0.99	15 / 0.98	23 / 0.96	21 / 0.94	18 / 0.93	15 / 0.91	11 / 0.90	NR	NR	NR
	9.53 [3/8]	15.88 [5/8]	43	36	8 / 0.99	15 / 0.98	23 / 0.96	30 / 0.94	30 / 0.93	29 / 0.91	27 / 0.90	NR	NR	NR
	7.94 [5/16]	19.05 [3/4]	65	53	8 / 1.00	15 / 0.99	23 / 0.99	21 / 0.98	18 / 0.98	15 / 0.97	11 / 0.96	8 / 0.96	4 / 0.95	NR
	9.53 [3/8]	19.05 [3/4]	43	36	8 / 1.00	15 / 0.99	23 / 0.99	30 / 0.98	30 / 0.98	29 / 0.97	27 / 0.96	26 / 0.96	25 / 0.95	24 / 0.95
10.6 KW [3 Ton]	7.94 [5/16]	15.88 [5/8]	n/a	n/a	8 / 0.99	15 / 0.97	20 / 0.94	15 / 0.92	10 / 0.90	NR	NR	NR	NR	NR
	9.53 [3/8]	15.88 [5/8]	33	26	8 / 0.99	15 / 0.97	23 / 0.94	29 / 0.92	27 / 0.90	NR	NR	NR	NR	NR
	7.94 [5/16]	19.05 [3/4]	n/a	39	8 / 1.00	15 / 0.99	20 / 0.98	15 / 0.98	10 / 0.97	5 / 0.96	NR	NR	NR	NR
	9.53 [3/8]	19.05 [3/4]	33	26	8 / 1.00	15 / 0.99	23 / 0.98	29 / 0.98	27 / 0.97	26 / 0.96	24 / 0.95	22 / 0.94	20 / 0.93	19 / 0.93
	12.7 [1/2]	19.05 [3/4]	17	13	8 / 1.00	15 / 0.99	23 / 0.98	30 / 0.98	30 / 0.97	30 / 0.96	30 / 0.95	30 / 0.94	30 / 0.93	30 / 0.93
12.3 KW [3.5 Ton]	7.94 [5/16]	22.23 [7/8]	n/a	39	8 / 1.00	15 / 1.00	20 / 1.00	15 / 0.99	10 / 0.99	5 / 0.99	NR	NR	NR	NR
	9.53 [3/8]	22.23 [7/8]	33	26	8 / 1.00	15 / 1.00	23 / 1.00	29 / 0.99	27 / 0.99	26 / 0.99	24 / 0.98	22 / 0.98	20 / 0.98	19 / 0.97
	12.7 [1/2]	22.23 [7/8]	17	13	8 / 1.00	15 / 1.00	23 / 1.00	30 / 0.99	30 / 0.99	30 / 0.99	30 / 0.98	30 / 0.98	30 / 0.98	30 / 0.97
	9.53 [3/8]	19.05 [3/4]	46	31	8 / 0.99	15 / 0.98	23 / 0.97	27 / 0.96	24 / 0.95	22 / 0.94	20 / 0.92	17 / 0.91	15 / 0.90	NR
	12.7 [1/2]	19.05 [3/4]	23	15	8 / 0.99	15 / 0.98	23 / 0.97	30 / 0.96	30 / 0.95	30 / 0.94	30 / 0.92	30 / 0.91	30 / 0.90	NR
14.1 KW [4 Ton]	9.53 [3/8]	22.23 [7/8]	46	31	8 / 1.00	15 / 1.00	23 / 0.99	27 / 0.99	24 / 0.99	22 / 0.98	20 / 0.97	17 / 0.97	15 / 0.96	13 / 0.96
	12.7 [1/2]	22.23 [7/8]	23	15	8 / 1.00	15 / 1.00	23 / 0.99	30 / 0.99	30 / 0.99	30 / 0.98	30 / 0.97	30 / 0.97	30 / 0.96	30 / 0.96
	9.53 [3/8]	19.05 [3/4]	45	34	8 / 0.99	15 / 0.98	23 / 0.96	24 / 0.95	20 / 0.93	17 / 0.92	14 / 0.91	NR	NR	NR
	12.7 [1/2]	19.05 [3/4]	23	17	8 / 0.99	15 / 0.98	23 / 0.96	30 / 0.95	30 / 0.93	30 / 0.92	30 / 0.91	NR	NR	NR
	9.53 [3/8]	22.23 [7/8]	45	34	8 / 1.00	15 / 0.99	23 / 0.99	24 / 0.98	20 / 0.97	17 / 0.97	14 / 0.96	11 / 0.96	8 / 0.95	5 / 0.95
17.6 KW [5 Ton]	12.7 [1/2]	22.23 [7/8]	23	17	8 / 1.00	15 / 0.99	23 / 0.99	30 / 0.98	30 / 0.97	30 / 0.97	30 / 0.96	30 / 0.96	30 / 0.95	30 / 0.95
	9.53 [3/8]	19.05 [3/4]	24	0	8 / 0.99	15 / 0.97	23 / 0.94	19 / 0.92	14 / 0.90	NR	NR	NR	NR	NR
	12.7 [1/2]	19.05 [3/4]	12	0	8 / 0.99	15 / 0.97	23 / 0.94	30 / 0.92	30 / 0.90	NR	NR	NR	NR	NR
	9.53 [3/8]	22.23 [7/8]	24	0	8 / 1.00	15 / 0.99	23 / 0.98	19 / 0.97	14 / 0.96	10 / 0.95	5 / 0.94	NR	NR	NR
	12.7 [1/2]	22.23 [7/8]	12	0	8 / 1.00	15 / 0.99	23 / 0.98	30 / 0.97	30 / 0.96	30 / 0.95	30 / 0.94	29 / 0.94	28 / 0.93	27 / 0.92
	9.53 [3/8]	28.58 [1-1/8]	24	0	8 / 1.01	15 / 1.01	23 / 1.00	19 / 1.00	14 / 0.99	10 / 0.99	5 / 0.99	NR	NR	NR
	12.7 [1/2]	28.58 [1-1/8]	12	0	8 / 1.01	15 / 1.01	23 / 1.00	30 / 1.00	30 / 0.99	30 / 0.99	30 / 0.99	29 / 0.99	28 / 0.99	27 / 0.98

Notes:

- 1) Do not exceed 61 meters linear line length.
- 2) * Do not exceed 55 meters vertical separation if outdoor unit is above indoor unit.
- 3) ** 19.05 mm [3/4 in.] vapor line should only be used for 1.5 ton systems if outdoor unit is below or at same level as indoor unit to assure proper oil return.
- 4) Always use the smallest liquid line allowable to minimize refrigerant charge.
- 5) Applications shaded in light gray indicate capacity multipliers between 0.90 and 0.96 which are not recommended, but are allowed.
- 6) Applications shaded in dark gray are not recommended due to excessive liquid or suction pressure drop.

Example: A (-)A14AZ36AJ1N is installed 50' below the indoor unit, requires 75' of 1/2" diameter liquid line, 3/4" diameter suction line, and 4 90° LR elbows, and a filter drier.

- Fitting Equivalent Length (ft.) = (4 × .9) + 6 = 9.6'
- Total Equivalent Length (ft.) = 75' + 9.6' = 84.6'

This application is acceptable because the 50' vertical rise is less than the maximum rise of 100' for this application. The application is also considered to have a long line set since 75 linear feet exceeds the limit of 43 feet. Reference the long line set section of the I&O for detail.

Unit Size	Allowable Liquid Line Size	Allowable Suction Line Size	Apply Long Line Guidelines if Linear Line Length Exceeds Those Shown Below (Feet)				Equivalent Length (Feet)										
			(-)A13	(-)A14 A/B/C	(-)A14 W/X	(-)A16	< 25	26-50	51-75	76-100	101-125	126-150	151-175	176-200	201-225	226-250	
							Maximum Vertical Rise (Outdoor Unit Below Indoor Unit) * / Capacity Multiplier										
3 Ton	5/16"	5/8"	n/a	n/a	n/a	n/a	25 / 0.99	50 / 0.97	66 / 0.94	49 / 0.92	32 / 0.90	NR	NR	NR	NR	NR	NR
	3/8"	5/8"	108	85	90	82	25 / 0.99	50 / 0.97	75 / 0.94	95 / 0.92	89 / 0.90	NR	NR	NR	NR	NR	NR
	5/16"	3/4"	n/a	128	135	123	25 / 1.00	50 / 0.99	66 / 0.98	49 / 0.98	32 / 0.97	15 / 0.96	NR	NR	NR	NR	NR
	3/8"	3/4"	108	85	90	82	25 / 1.00	50 / 0.99	75 / 0.98	95 / 0.98	89 / 0.97	84 / 0.96	78 / 0.95	72 / 0.94	67 / 0.93	61 / 0.93	
	1/2"	3/4"	54	43	45	41	25 / 1.00	50 / 0.99	75 / 0.98	100 / 0.98	100 / 0.97	100 / 0.96	100 / 0.95	100 / 0.94	100 / 0.93	100 / 0.93	
	5/16"	7/8"	n/a	128	135	123	25 / 1.00	50 / 1.00	66 / 1.00	49 / 0.99	32 / 0.99	15 / 0.99	NR	NR	NR	NR	NR
	3/8"	7/8"	108	85	90	82	25 / 1.00	50 / 1.00	75 / 1.00	95 / 0.99	89 / 0.99	84 / 0.99	78 / 0.98	72 / 0.98	67 / 0.98	61 / 0.97	
	1/2"	7/8"	54	43	45	41	25 / 1.00	50 / 1.00	75 / 1.00	100 / 0.99	100 / 0.99	100 / 0.99	100 / 0.99	100 / 0.98	100 / 0.98	100 / 0.98	100 / 0.97

(Excerpt from Table 2A)

4.0 INSTALLATION



4.4 Refrigerant Line Set Selection (cont.)

4.4.4 Suction Line Selection

Purpose of the vapor line is to return superheated vapor to the condensing unit from the evaporator. Proper suction line sizing is important because it plays an important role in returning oil to the compressor to prevent potential damage to the bearings, valves, and scroll sets. Also, an undersized suction line can dramatically reduce capacity and performance of the system. The procedure for selecting the proper suction line is as follows:

- Determine the total linear length of suction line required.
- Add all of the equivalent lengths associated with any fittings or accessories using the table on previous page.
- Add the linear length and total fitting equivalent length. This will equal your total equivalent length.
- Reference Table 2 to verify that the calculated equivalent length falls within the acceptable region of the chart.
- Verify the capacity difference is compatible with the application using the multiplier in Table 2.
- Use only suction line sizes listed in Table 2.

4.4.5 Long Line Set Considerations

Long line set applications are defined as applications that require accessories or alternate construction methods. The following things should be considered when selecting and installing a long line set:

- Additional refrigerant charge
- Fitting losses and maximum equivalent length considerations
- Refrigerant migration during the off cycle
- Oil return to the compressor
- Capacity losses
- System oil level adjustment

4.4.5.1 Determining if Long Line Set Length Requirements Apply

Table 2 is used to determine if the application is considered to have a long line set. A column is provided that shows the linear line length where long line length requirements apply.

4.4.5.2 Oil Return to Compressor

Small amounts of compressor crankcase oil is picked up and carried out of the compressor by the moving refrigerant and is circulated through the

system along with the refrigerant before it returns to the compressor crankcase. It is critical to the life of the compressor for the oil to be able to return to the compressor to maintain an adequate level of oil in the compressor crankcase. Oversized vapor lines result in inadequate refrigerant velocities to carry the oil along with the refrigerant and will cause the oil to accumulate in the low spots in the vapor line instead of being returned to the compressor crankcase. This is especially true for long line lengths. Only use the vapor line sizes listed in Table 2 to assure proper oil return. Do not oversize the vapor line.

4.4.5.3 Refrigerant Migration During Off Cycle

Long line set applications can require a considerable amount of additional refrigerant. This additional refrigerant needs to be managed throughout the entire ambient operating envelope that the system will go through during its life cycle. Off-Cycle migration is where excess refrigerant condenses and migrates to the coldest and/or lowest part of the system. Excessive build-up of refrigerant at the compressor will result in poor reliability and noisy operation during startup. Long line applications require TXV's on both the indoor coil and outdoor unit and a crankcase heater. (See Section 7.6 for crankcase heater information.)

4.4.5.4 Maximum Liquid Pressure Drop

The total liquid line pressure drop must not exceed 50 psig [345 kPa] to assure a solid column of liquid at the metering device and stable control of superheat. Be sure to account for vertical separation, elbows, filter driers, solenoid valves, sight glasses, and check valves when calculating liquid line pressure drop.

4.4.5.5 Liquid Line Refrigerant Flashing

Excessive pressure drop and heat gain in long liquid lines can result in the refrigerant flashing into a vapor before it reaches the metering device which will dramatically reduce the capacity and efficiency of the system. For this reason, the liquid line must be sized properly using the table in Table 2 and must be insulated in unconditioned spaces.

4.0 INSTALLATION



4.4 Refrigerant Line Set Selection (cont.)

4.4.5.6 Oil Level Adjustment for Long Line Set Applications

Additional oil may need to be added for long line set applications. If the system contains more than 20 lbs [9 kg] of refrigerant charge, add 1 fluid oz of POE oil for every 5 lbs [13 ml/kg] of refrigerant charge over 20 lbs [9 kg].

4.4.5.7 Capacity Losses

Long line lengths can result in a reduction in capacity due to suction line pressure drop and heat gain. Refer to Table 2 for capacity loss multipliers for various vapor line diameters and lengths. Only use vapor lines listed in Table 2 to assure proper oil return. This table does not account for any capacity loss due to heat gain from the environment. It is extremely important not to oversize the suction line to minimize capacity loss at the expense of proper oil return. If the table shows an “NR” for a particular vapor line diameter and length, capacity loss will be excessive. The full length of the suction line must be insulated to minimize heat gain.

4.0 INSTALLATION



4.5 Line Set Installation

- If tubing is to be run underground, it must be run in a sealed watertight chase.
- Use care in routing tubing and do not kink or twist. Use a good quality tubing bender on the vapor line to prevent kinking.

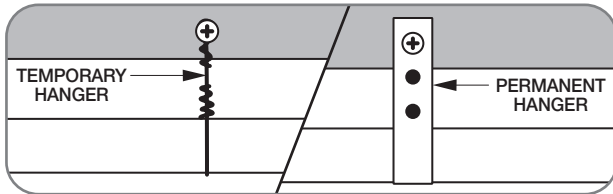

- Route the tubing using temporary hangers; then straighten the tubing and install permanent hangers. The tubing must be adequately supported.
- Isolate the vapor line from the building structure. If the vapor line comes in contact with inside walls, ceiling, or flooring, the vibration of the vapor line

in the heating mode will result in noise inside the structure.

- Blow out the liquid and vapor lines with dry nitrogen before connecting to the outdoor unit and indoor coil to remove debris that can plug the expansion device.

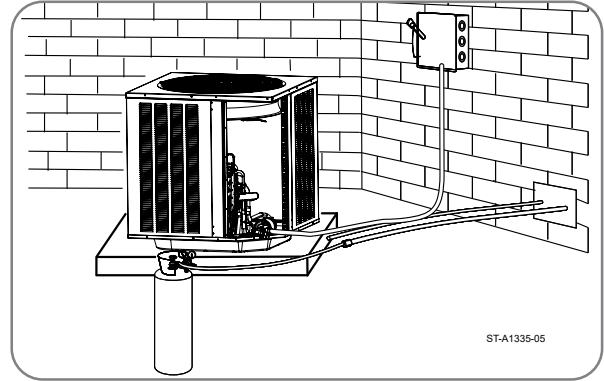

4.5.1 Important Tubing Installation Practices

Observe the following when installing correctly sized type “L” refrigerant tubing between the outdoor unit and indoor coil:

- Check the tables on Table 2 for the correct suction line size and liquid line size.
- **If a portion of the liquid line passes through a very hot area where liquid refrigerant can be heated to form vapor, insulating the liquid line is required.**
- Use clean, dehydrated, sealed refrigeration-grade tubing.
- Always keep tubing sealed until tubing is in place and connections are to be made.
- A high-quality filter drier is included with all units and must be installed in the liquid line upon unit installation.
- When replacing an R-22 system with an R-410A system and the line set is not replaced, blow out the lines with dry nitrogen to remove as much of the remaining mineral oil as possible. Check for low spots where oil may be trapped and take measures to drain the oil from those areas.



- If tubing has been cut, deburr the ends while holding the tubing in a position to prevent chips from falling into tubing. Burrs such as those caused by tubing cutters can affect performance dramatically, particularly on small diameter liquid lines.
- For best operation, keep tubing run as short as possible with a minimum number of elbows or bends.
- Locations where the tubing will be exposed to mechanical damage should be avoided. If it is necessary to use such locations, the copper tubing should be protected by a housing to prevent damage.

4.0 INSTALLATION



4.5 Line Set Installation (cont.)

4.5.2 Relative Location of Indoor and Outdoor Units

4.5.2.1 Indoor and Outdoor Unit Near Same Level

OUTDOOR UNIT LEVEL OR NEAR LEVEL TO INDOOR SECTION LINE SET

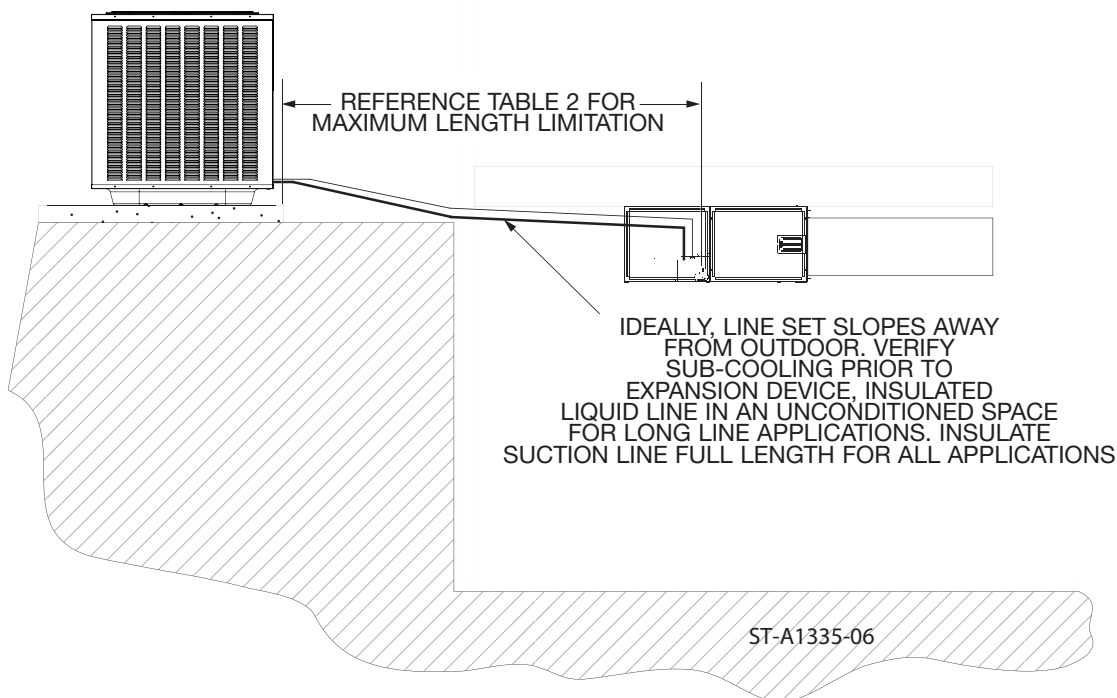

For applications that are considered to have a long line set with the outdoor unit and indoor unit near the same level the following is required:

- TXV on the indoor coil
- Start components may be required depending upon quality of voltage (consistently <200 vac at outdoor unit)
- Crankcase heater (Some models have factory installed CCH's. Refer to tables in Section 4.4.5.6.)
- Insulated liquid line in unconditioned space only. Insulated suction line full length.
- Suction line should slope toward the indoor unit
- Follow the proper line sizing, maximum linear and equivalent lengths, charging requirements, and oil level adjustments spelled out in this manual.
- Verify at least 5°F [2.8°C] liquid sub-cooling at the indoor unit prior to expansion device.

4.0 INSTALLATION



4.5 Line Set Installation (cont.)

4.5.2.2 Outdoor Unit Below Indoor Unit

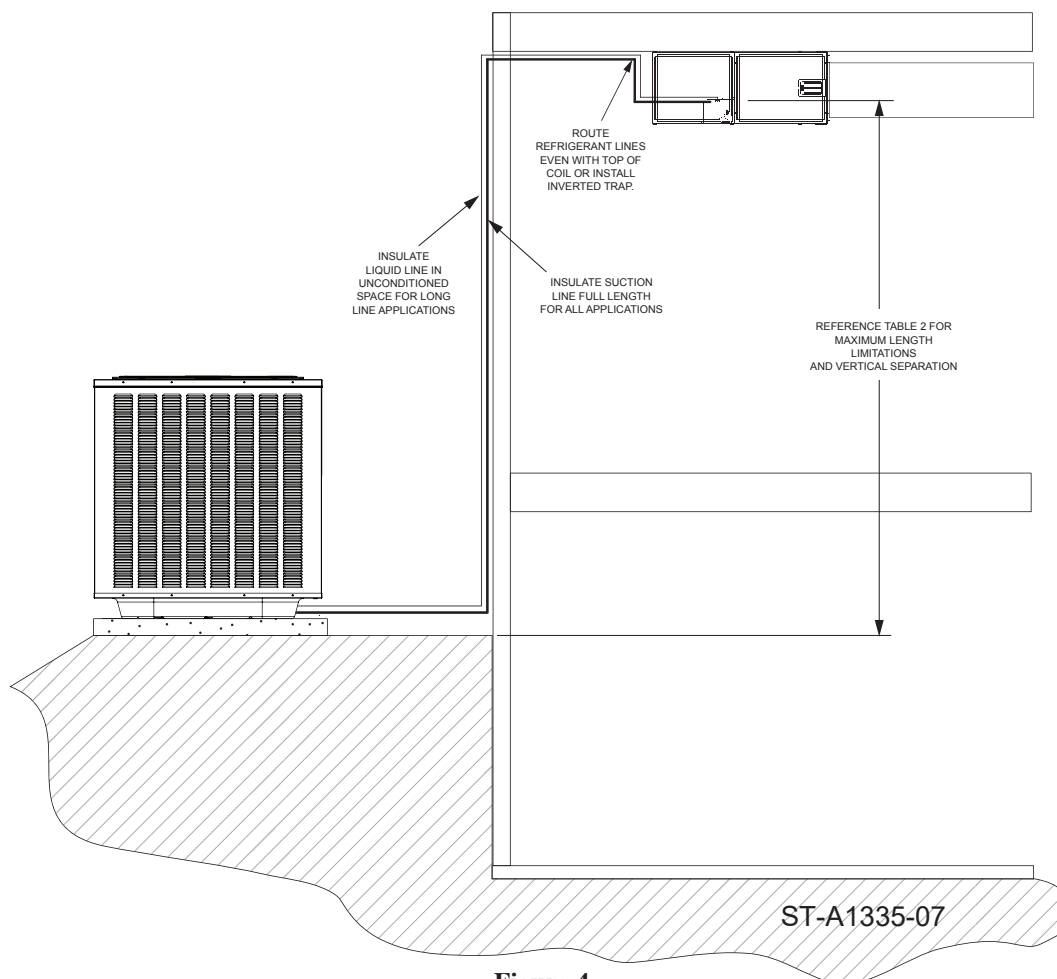

Figure 4

For applications that are considered to have a long line set with the outdoor unit below the indoor unit the following is required:

- TXV or at the indoor coil.
- Crankcase heater (Some models have factory installed CCH's. Refer to tables in Section 4.4.5.6.)
- Start components may be required depending upon quality of voltage (consistently <200 vac at outdoor unit)
- Refrigerant lines should be routed even with the top of the indoor coil or an inverted trap is to be applied (refer to Figure 4).
- Insulated liquid line in unconditioned space only.
- Insulated suction line full length.
- Follow the proper line sizing, maximum linear and equivalent lengths, charging requirements, and oil level adjustments spelled out in this manual.
- Verify at least 5°F [2.8°C] liquid sub-cooling at the indoor unit prior to expansion device.
- Vertical separations greater than 25' [7.62 m] can expect a lower sub-cooling level.

4.0 INSTALLATION



4.5 Line Set Installation (cont.)

4.5.2.3 Outdoor Unit Above Indoor Unit

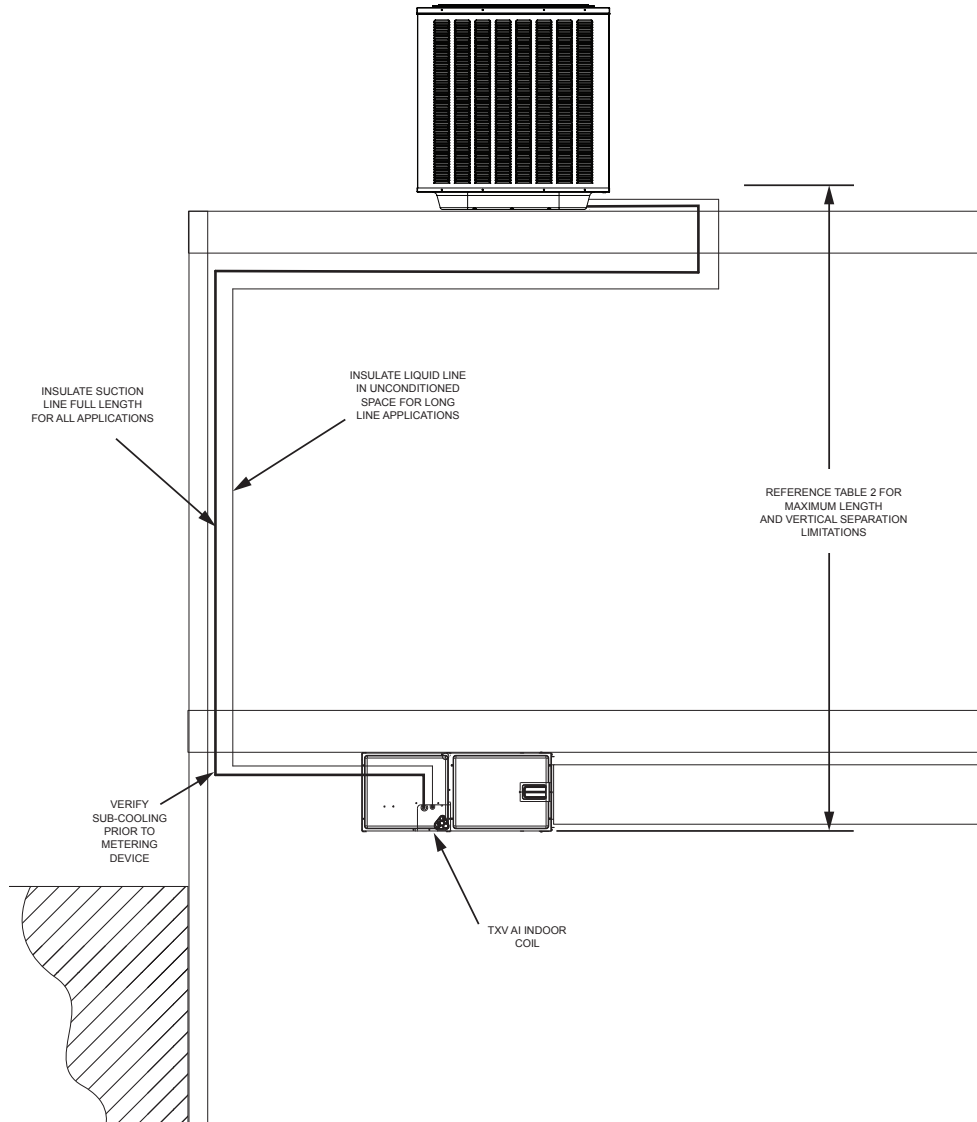

For applications that are considered to have a long line set with the outdoor unit above the indoor unit the following is required:

- TXV on the indoor coil.
- Crankcase heater (Some models have factory installed CCH's. Refer to tables in Section 4.4.5.6.)
- Start components maybe required depending upon quality of voltage (consistently <200 vac at outdoor unit)

- Insulated liquid line in unconditioned space only. Insulated suction line full length.
- Follow the proper line sizing, maximum linear and equivalent lengths, charging requirements, and oil level adjustments spelled out in this manual.

4.0 INSTALLATION



4.5 Line Set Installation (cont.)

4.5.3 Tubing Connections

Indoor coils have only a holding charge of dry nitrogen. Keep all tube ends sealed until connections are to be made.

- Use type “L” copper refrigeration tubing. Braze the connections with the following alloys:
 - Copper to copper, 5% silver minimum
 - Copper to steel or brass, 15% silver minimum

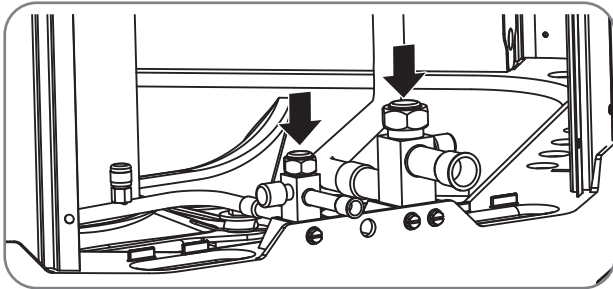

- Be certain both refrigerant shutoff valves at the outdoor unit are closed.

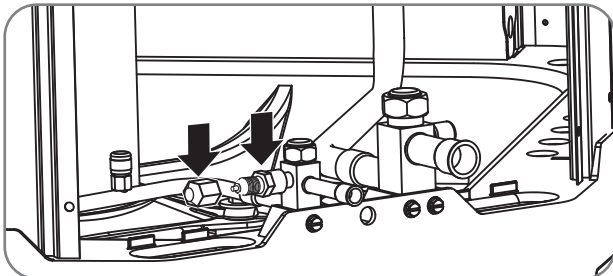

- Remove the caps and Schrader cores from the pressure ports to protect seals from heat damage. Both the Schrader valves and the service valves have seals that may be damaged by excessive heat.

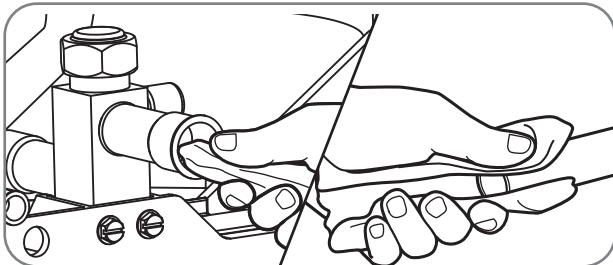

- Clean the inside of the fittings and outside of the tubing with a clean, dry cloth before soldering. Clean out debris, chips, dirt, etc., that enters tubing or service valve connections.

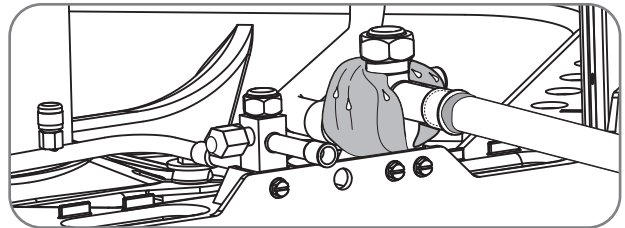

- Wrap valves with a wet rag or thermal barrier compound before applying heat.

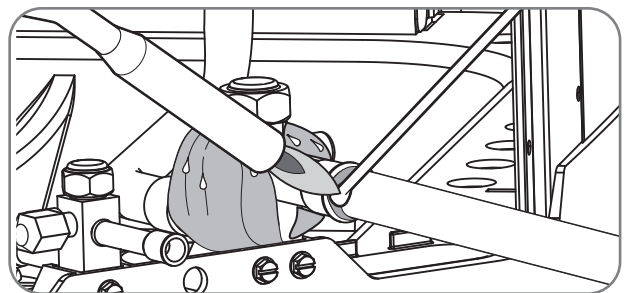

- Braze the tubing between the outdoor unit and indoor coil. Flow dry nitrogen into a pressure port and through the tubing while brazing, but do not allow pressure inside tubing which can result in leaks. Once the system is full of nitrogen, the nitrogen regulator should be turned off to avoid pressuring the system.

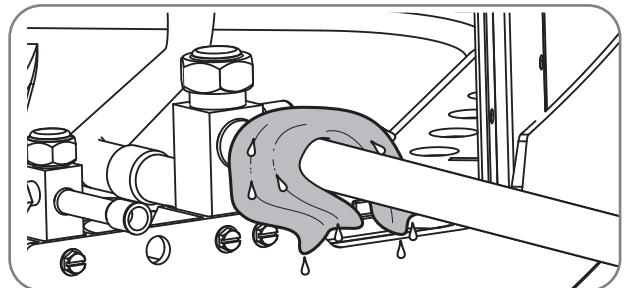

- After brazing, use an appropriate heatsink material to cool the joint.
- Reinstall the Schrader cores into both pressure ports.

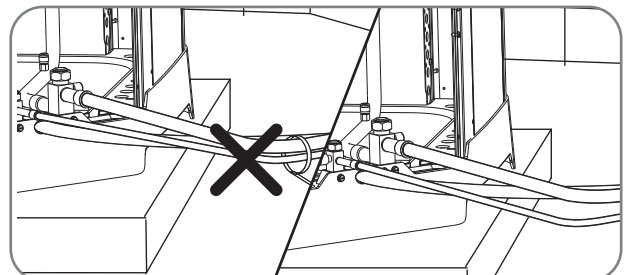

- Do not allow the bare suction line and liquid line to be in contact with each other. This causes an undesirable heat transfer resulting in capacity loss and increased power consumption.

4.0 INSTALLATION

4.6 Initial Leak Testing

Indoor coils have only a holding charge of dry nitrogen. Keep all tube ends sealed until connections are to be made.

⚠WARNING: Do not use oxygen to purge lines or pressurize system for leak test. Oxygen reacts violently with oil, which can cause an explosion resulting in severe personal injury or death.

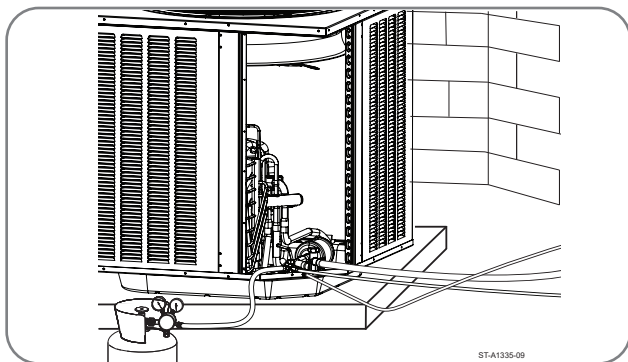

- Pressurize line set and coil through service fittings with dry nitrogen to a maximum of 150 PSIG [1034 kPa]. Close nitrogen tank valve, let system sit for at least 15 minutes, and check to see if the pressure has dropped. If the pressure has dropped, check for leaks at the line set braze joints with soap bubbles and repair leak as necessary. Repeat pressure test. If line set and coil hold pressure, proceed with line set and coil evacuation (see Sections 4.7 and 4.8 for evacuation and final leak testing).

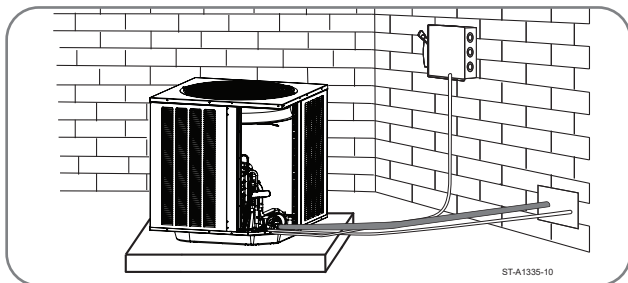

- The suction line must be insulated for its entire length to prevent dripping (sweating) and prevent performance losses. Closed-cell foam insulation such as Armaflex and Rubatex® are satisfactory insulations for this purpose. Use 1/2" [12.7 mm] minimum insulation thickness. Additional insulation may be required for long runs. The liquid line must be insulated in any unconditioned space when long line sets are used and anytime the liquid line is run through an attic due to hot temperatures that occur there.

4.7 Evacuation

Evacuation is one of the most important parts of the entire installation and service procedure. The life and efficiency of the equipment is dependent upon the thoroughness exercised by the serviceman when evacuating air and moisture from the system.

Air or nitrogen in the system increases condensing temperature and pressure, resulting in increased power consumption, erratic operation, and reduced capacity.

Moisture chemically reacts with the refrigerant and oil to form corrosive acid which attacks the compressor motor windings and internal parts and which can result in compressor failure.

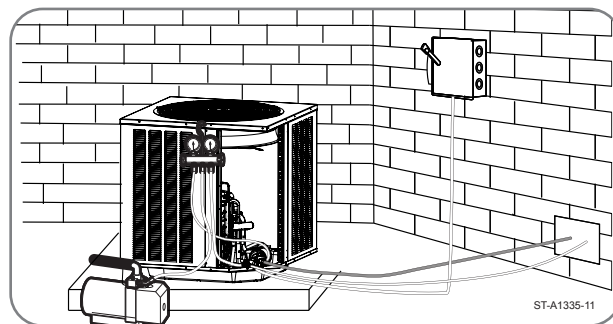

- After the system has been leak-checked and proven sealed, connect the vacuum pump and evacuate system to 500 microns and hold 500 microns or less for at least 15 minutes. The vacuum pump must be connected to both the high and low sides of the system by connecting to the two pressure ports. Use the largest size connections available since restrictive service connections may lead to false readings because of pressure drop through the fittings.

4.8 Final Leak Testing

After the unit has been properly evacuated and service valves opened, a halogen leak detector should be used to detect leaks in the system. All joints and piping within the outdoor unit, evaporator, and interconnecting tubing should be checked for leaks. If a leak is detected, the refrigerant should be recovered before repairing the leak. The Clean Air Act prohibits releasing refrigerant into the atmosphere.

4.0 INSTALLATION



4.9 Control Wiring

⚠WARNING: Turn off electric power at the fuse box or service panel before making any electrical connections. Also, the ground connection must be completed before making line voltage connections. Failure to do so can result in electrical shock, severe personal injury, or death.

Running low-voltage wires in conduit with line voltage power wires is not recommended. Low-voltage wiring should be attached to the pigtails below the control box.

A thermostat and a 24-volt, 40 VA minimum transformer are required for the control circuit of the system. The furnace or the air handler transformer may be used if sufficient. See the wiring diagram for reference. Use “Wire Size”

guide below to size the 24-volt control wiring. Do not use phone cord to connect indoor and outdoor units and thermostat. This could damage the controls and may not be adequately sized for the control’s electrical load.

FIELD WIRE SIZE FOR 24-VOLT THERMOSTAT CIRCUITS:

Runs up to 100 ft [30.5 m]: 18 AWG
Runs over 100 ft [30.5 m]: 16 AWG

NOTICE: Do not use control wiring smaller than No. 18 AWG between thermostat and outdoor unit.



4.10 Typical Control Wiring Connections

The following figures show the typical wiring connections for a single-stage condensing unit with a gas/oil furnace or with an air-handler with electric heat.

WIRE COLOR CODE		
BK – BLACK	GY – GRAY	W – WHITE
BR – BROWN	O – ORANGE	Y – YELLOW
BL – BLUE	PR – PURPLE	
G – GREEN	R – RED	

Wiring

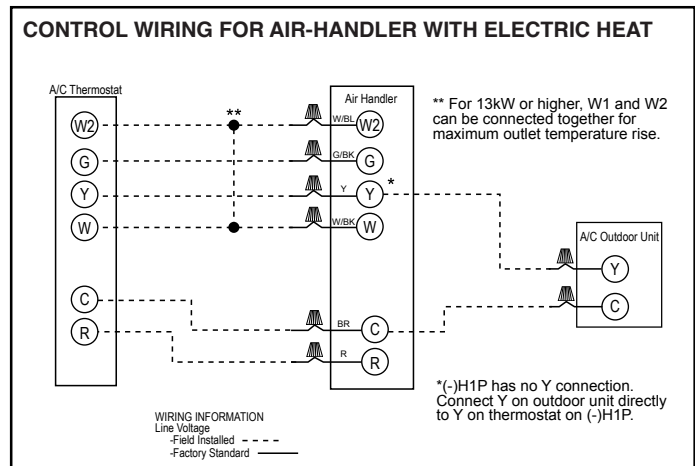
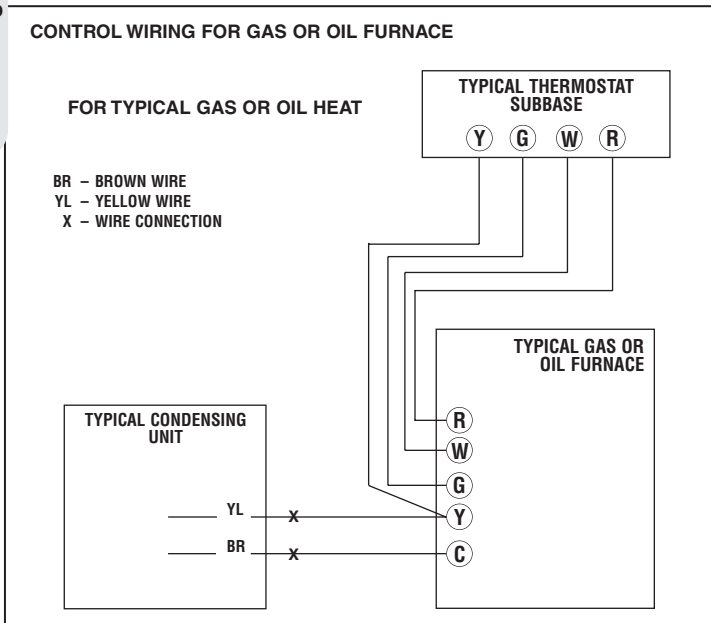

4.0 INSTALLATION



4.10 Typical Control Wiring Connections (cont.)

NOTICE: Field wiring must comply with the National Electric Code (C.E.C. in Canada) and any applicable local code.

4.11 Power Wiring

It is important that proper electrical power from a commercial utility is available at the outdoor unit contactor. Voltage ranges for operation are shown below.

VOLTAGE RANGES

Nameplate Voltage	Operating Voltage Range at Maximum Load Design Conditions for Compressors
208/230	187 - 253
380/415	342 - 457
460	414 - 506
575	517 - 633

Install a branch circuit disconnect within sight of the unit and of adequate size to handle the minimum circuit capacity (see Section 3.3).

Power wiring must be run in a rain-tight conduit. Conduit must be attached to the hole in the bottom of the control box as shown below.

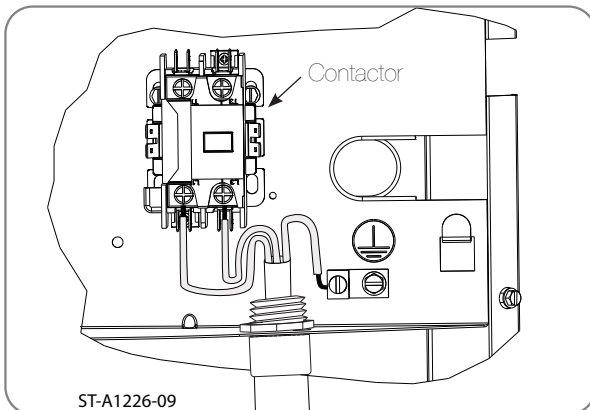

Connect the power wiring to the line voltage lugs on the contactor located in the unit electrical box. (See wiring diagram attached to unit access panel and above illustration.)

Check all electrical connections, including factory wiring within the unit and make sure all connections are tight.

DO NOT connect aluminum field wire to the contactor lugs.

4.12 Grounding

⚠WARNING: The unit must be permanently grounded. Failure to do so can cause electrical shock resulting in severe personal injury or death.

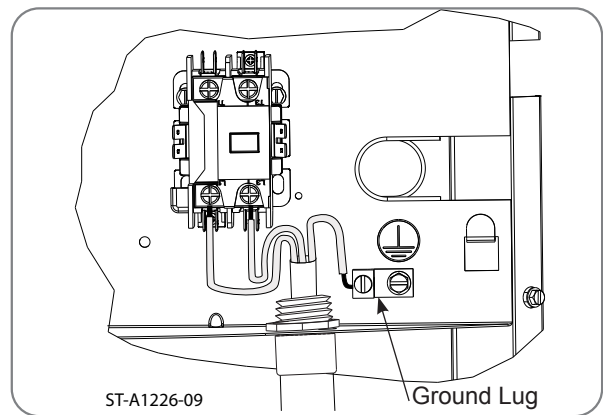

A grounding lug is provided near the line-voltage power entrance for a ground wire as shown in the above illustration.

5.0 SYSTEM START-UP & REFRIGERANT CHARGING

5.1 System Start-Up Overview

Once the system hardware and wiring has been properly installed, the next step is to start the system up, verify indoor air-flow, and adjust the refrigerant charge. To assure optimum comfort, efficiency, and reliability, it is extremely important to follow the procedures in this section to assure the indoor air-flow and refrigerant charge are correct.

⚠WARNING: Single-pole contactors are used on all standard single-phase units through 5 tons. Caution must be exercised when servicing as only one leg of the power supply is broken by the contactor.

5.2 Initial System Power-Up

After all installation steps have been completed, apply electrical power to the indoor unit only until the indoor air-flow is verified (See Section 5.3).

After the indoor air-flow has been verified and the preliminary refrigerant charge has been weighed in (see section 5.4.2), electrical power may be applied to the outdoor unit. If the unit is equipped with a crankcase heater, it is recommended to wait at least 12 hours after electrical power is applied to the outdoor unit before starting the compressor to assure any liquid refrigerant inside the compressor has been driven out by the crankcase heater.

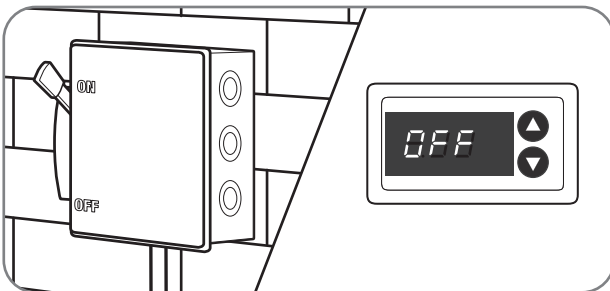

5.3 Verifying Indoor Air-Flow

The air distribution system has the greatest effect on airflow. The duct system is totally controlled by the contractor. For this reason, the contractor should use only industry-recognized procedures.

Duct design and construction should be carefully done. System performance can be lowered dramatically through bad planning or workmanship.

Air supply diffusers must be selected and located carefully. They must be sized and positioned to deliver treated air along the perimeter of the space. If they are too small for their intended airflow, they become noisy. If they are not located properly, drafts can result. Return air grilles must be properly sized to carry air back to the blower. If they are too small, they also cause noise.

The installers should balance the air distribution system to ensure proper and quiet airflow to all rooms in the home. This ensures a comfortable living space.

The correct air quantity is critical to air conditioning systems. Proper operation, efficiency, compressor life, and humidity control depend on the correct balance between indoor load and outdoor unit capacity. Excessive indoor airflow increases the possibility of high humidity problems. Low indoor airflow reduces total capacity and can cause coil icing. Serious harm can be done to the compressor by low airflow, such as that caused by refrigerant flooding.

Air-conditioning systems require a specified airflow. Each ton of cooling requires between 320 CFM [151 l/s] and 450 CFM [212 l/s]. See the manufacturer's spec sheet or the AHRI Directory (ahridirectory.org) for rated airflow for the system being installed.

The indoor air-flow must be verified to be correct before the refrigerant charging process can begin. Determine the rated indoor air-flow by referring to the AHRI Directory or manufacturer's outdoor unit specifications for the particular indoor and outdoor unit combination being installed. Then refer to the air-handler or gas furnace installation manual to determine how to select the proper air-flow and make the necessary adjustments to achieve as close to the rated indoor air-flow as possible. Once the adjustments have been made, the air-handler or gas furnace blower can be started by turning the thermostat to the heating mode and adjusting the set point above the room temperature so the air-flow level can be verified using the following methods.

IMPORTANT: Power to the outdoor unit must remain off until the indoor air-flow is verified and the outdoor unit service valves are opened to release the factory refrigerant charge into the line set and indoor coil.

These simple mathematical formulas can be used to determine the CFM [l/s] in a residential or light commercial system.

Electric resistance heaters can use:

$$\text{CFM} = \frac{\text{volts} \times \text{amps} \times 3.413}{\text{SHC} \times \text{temp rise}}$$

5.0 SYSTEM START-UP & REFRIGERANT CHARGING

$$\text{l/s} = \frac{\text{Volts} \times \text{Amps} \times 0.895}{\text{SHC} \times \text{temp rise } ^\circ\text{C}}$$

Gas furnaces can use:

$$\text{CFM} = \frac{\text{Output Capacity in BTUH}^*}{\text{SHC} \times \text{temp rise}}$$

$$\text{l/s} = \frac{\text{Output Capacity in kW} \times 895}{\text{SHC} \times \text{temp rise } ^\circ\text{C}}$$

*Refer to furnace data plate for furnace output capacity.
SHC = Sensible Heat Constant (see table below)

An air velocity meter or airflow hood can give a more accurate reading of the system CFM [l/s].

The measurement for temperature rise should be performed at the air-handler or furnace return air inlet and in the supply plenum, but out of direct line of sight of the heater element or heat exchanger. For best results, measure air temperature at multiple points and average the measurements to obtain inlet and outlet temperatures.

ALTITUDE FT. [M]	SENSIBLE HEAT CONSTANT (SHC)	ALTITUDE FT. [M]	SENSIBLE HEAT CONSTANT (SHC)
Sea Level	1.08	6000 [1829]	0.87
500 [152]	1.07	7000 [2134]	0.84
1000 [305]	1.05	8000 [2438]	0.81
2000 [610]	1.01	9000 [2743]	0.78
3000 [914]	0.97	10000 [3048]	0.75
4000 [1219]	0.94	15000 [4572]	0.61
5000 [1524]	0.90	20000 [6096]	0.50

5.4 Refrigerant Charging

⚠ WARNING: The top of the scroll compressor shell is hot. Touching the compressor top may result in serious personal injury.

⚠ CAUTION: R-410A pressures are approximately 60% higher (1.6 times) than R-22 pressures. Use appropriate care when using this refrigerant. Failure to exercise care may result in equipment damage or personal injury.

Charge for all systems should be checked using the Charging Chart inside the access panel cover.

IMPORTANT: Do not operate the compressor without charge in the system.

Addition of R-410A will raise high-side pressures (liquid and discharge).

NOTICE: System maintenance is to be

performed by a qualified and certified technician. The refrigerant charge for all systems should be checked against the Charging Chart located inside the access panel cover.

The optimum refrigerant charge for any outdoor unit matched with an indoor coil/air handler is affected by the application. Therefore, charging data has been developed to assist the field technician in optimizing the charge. Refer to the charging chart inside the access panel cover on the unit and choose the appropriate column for the specific model being installed or serviced.

The following method is used for charging systems in the cooling mode. All steps listed should be performed to ensure proper charge has been set.

5.4.1 Measurement Device Set-Up

1. With an R-410A gauge set, attach the high-pressure hose to the access fitting on the liquid (small) service valve at the outdoor unit.
2. Attach the low-pressure hose to the access fitting on the service (large) valve at the outdoor unit.
3. Attach a temperature probe within 6" [15.2 cm] of the outside of the unit on the copper liquid line (small line). For more accurate measurements, clean the copper line prior to measurement and use a calibrated clamp-on temperature probe or an insulated surface thermocouple.

5.4.2 Preliminary Charging by Weight

NOTICE: Adjust the system charge by weight for the linear length of the refrigerant line set.

For a new installation, evacuation of inter-connecting tubing and indoor coil is adequate; otherwise, evacuate the entire system. Use the factory charge shown in "Electrical and Physical Data" in Section 3.3 of these instructions or on the unit data plate. Note that the charge value includes charge required for 15 ft. [4.6 m] of standard-size liquid line without a filter drier.

Calculate actual charge required with the actual installed liquid line size and length using:

1/4" [6.4 mm] O.D. = .3 oz./ft. [28.3 g/m]

5/16" [7.9 mm] O.D. = .4 oz./ft. [37.7 g/m]

3/8" [9.5 mm] O.D. = .6 oz./ft. [56.7 g/m]

1/2" [12.7 mm] O.D. = 1.2 oz./ft. [113.3 g/m]

Add 6 oz. [170 g] for field-installed filter drier.

Charge Adjustment = (Line Set (oz./ft.) × Total Linear Length) – Factory Charge for Line Set + 6 oz. (for field installed filter drier)

5.0 SYSTEM START-UP & REFRIGERANT CHARGING

Example: A three-ton unit requires 75 ft. of line set with a liquid line diameter of 1/2".

Factory Charge for Line Set = 15 ft. × .6 oz. = 9 oz.

Charge Adjustment = (1.2 oz. × 75 ft.) – 9 oz. + 6 oz. = + 87 oz.

With an accurate scale (+/- 1 oz. [28.3 g]) or volumetric charging device, adjust the refrigerant charge based on the actual line set length. If the entire system has been evacuated, add the total calculated charge.

IMPORTANT: Charging by weight is not always accurate since the application can affect the optimum refrigerant charge. Charging by weight is considered a starting point ONLY. Always check the charge by using the Charging Chart and adjust as necessary. CHARGING BY LIQUID SUBCOOLING PER THE SYSTEM CHARGING CHART MUST BE USED FOR FINAL CHARGE ADJUSTMENT.

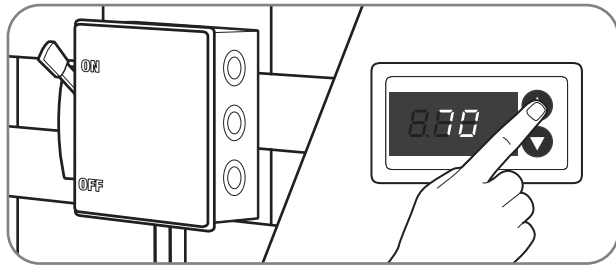

Charging

IMPORTANT: R-410A is a blended refrigerant of R-32 and R-125 (50/50). These two refrigerants have different saturation curves and therefore change state at different pressures and temperatures. If charge is added to the system in the vapor state, it is possible to have a disproportionate amount of each part of the R-410A blend which will cause unstable and inefficient operation. Therefore, it is critical to add R-410A in the liquid form only!

5.4.3 Preliminary Charging by Pressures

1. Following airflow verification and charge weighing, run the unit for a minimum of 15 minutes prior to noting pressures and temperatures.

IMPORTANT: Indoor conditions as measured at the indoor coil must be within 2°F [1.1°C] of comfort conditions per the homeowner's preference.

NOTICE: If the indoor temperature is above or below this range, run the system to bring the temperature down or run the electric heat/furnace to

bring the temperature within this range.

2. Note the Outdoor Dry Bulb Temperature, ODDB° = ____°F [°C]. Unit charging is recommended when the outdoor ambient temperature is 55°F [12.8°C] dry bulb and above

3. Locate and note the design pressures. The correct liquid and vapor pressures are found at the intersection of the installed system and the outdoor ambient temperature on the Charging Chart located inside the access panel cover.

Liquid Pressure: = ____psig [kPa]; Vapor Pressure = ____psig [kPa]

NOTICE: The refrigerant pressures provided are for preliminary charge check ONLY. These pressure values are typical, but may vary due to application. Evaporator load will cause pressures to deviate.

4. If the measured liquid pressure is below the listed requirement for the given outdoor and indoor conditions, add charge. If the measured liquid pressure is above the listed requirement for the given outdoor and indoor conditions, remove charge.

5.4.4 Final Charging by Liquid Subcooling

1. After preliminary charging by weight or pressures, find the design subcooling value. The correct subcooling value is found at the intersection of the installed system and the outdoor ambient temperature on the Charging Chart located inside the access panel cover.

SC° from Charging Chart = ____°F [°C].

IMPORTANT: Indoor conditions as measured at the indoor coil are required to be within 2°F (1.1°C) of comfort conditions as preferred by the homeowner and must have operated for at least 15 minutes prior to final charge adjustment. Unit charging is recommended when the outdoor ambient temperature is 55°F [12.8°C] dry bulb and above.

NOTICE: If the indoor temperature is above or below the recommended range, run the system to bring the temperature down or run the electric heat/furnace to bring the temperature up.

2. Note the measured Liquid Pressure, P_{liq} = ____psig [kPa], as measured from the liquid (small) service valve. Use the Temperature Pressure Chart below to note the corresponding

5.0 SYSTEM START-UP & REFRIGERANT CHARGING

saturation temperature for R-410A at the measured liquid pressure.

Liquid Saturation Temperature, SAT° = _____°F [°C].

- Note the liquid line temperature, Liq° = _____°F [°C], as measured from a temperature probe located within 6" [15.2 cm] outside of the unit on the copper liquid line (small line). It is recommended to use a calibrated clamp-on temperature probe or an insulated surface thermocouple.
- Subtract the liquid line temperature from the saturation temperature to calculate subcooling. SAT° _____°F [°C] - Liq° _____°F [°C] = SC° _____°F [°C]
- Adjust charge to obtain the specified subcooling value. If the measured subcooling level is below the listed requirement for the given outdoor temperature, add charge. If the measured subcooling level is above the listed requirement for the given outdoor temperature, remove charge.

5.4.5 R-410A Temperature Pressure Chart

SATURATION TEMP °F [°C]	R-410A PSIG [kPa]	SATURATION TEMP °F [°C]	R-410A PSIG [kPa]	SATURATION TEMP °F [°C]	R-410A PSIG [kPa]	SATURATION TEMP °F [°C]	R-410A PSIG [kPa]
-150 [-101]	-	-30 [-34]	17.9 [123.4]	35 [2]	107.5 [741.2]	100 [38]	317.4 [2188.4]
-140 [-96]	-	-25 [-32]	22.0 [151.7]	40 [4]	118.5 [817.0]	105 [41]	340.6 [2348.4]
-130 [-90]	-	-20 [-29]	26.4 [182.0]	45 [7]	130.2 [897.7]	110 [43]	365.1 [2517.3]
-120 [-84]	-	-15 [-26]	31.3 [215.8]	50 [10]	142.7 [983.9]	115 [46]	390.9 [2695.2]
-110 [-79]	-	-10 [-23]	36.5 [251.7]	55 [13]	156.0 [1075.6]	120 [49]	418.0 [2882.0]
-100 [-73]	-	-5 [-21]	42.2 [291.0]	60 [16]	170.1 [1172.8]	125 [52]	446.5 [3078.5]
-90 [-68]	-	0 [-18]	48.4 [333.7]	65 [18]	185.1 [1276.2]	130 [54]	476.5 [3285.4]
-80 [-62]	-	5 [-15]	55.1 [380.0]	70 [21]	201.0 [1385.8]	135 [57]	508.0 [3502.5]
-70 [-57]	-	10 [-12]	62.4 [430.2]	75 [24]	217.8 [1501.7]	140 [60]	541.2 [3731.4]
-60 [-51]	0.4 [2.8]	15 [-9]	70.2 [484.0]	80 [27]	235.6 [1624.4]	145 [63]	576.0 [3971.4]
-50 [-46]	5.1 [35.2]	20 [-7]	78.5 [541.2]	85 [29]	254.5 [1754.7]	150 [66]	612.8 [4225.1]
-40 [-40]	10.9 [75.2]	25 [-4]	87.5 [603.3]	90 [32]	274.3 [1891.2]		
-35 [-37]	14.2 [97.9]	30 [-1]	97.2 [670.2]	95 [35]	295.3 [2036.0]		

5.5 Completing Installation

- Disconnect the hoses from the pressure ports. Replace the pressure port caps and tighten adequately to seal caps. **Do not overtighten.**
- Replace the service valve top caps finger-tight and then tighten with a wrench to adequately seal caps. **Do not overtighten.**
- Replace control box cover and service panel and install screws to secure panels.
- Restore power to unit at disconnect if required.
- Configure thermostat per the thermostat installation instructions and set to desired mode and temperature.

6.0 SEQUENCE OF OPERATION

When the thermostat calls for cooling, the compressor, outdoor fan motor, and indoor blower motor are energized and the system provides cooling and dehumidification for the conditioned space. When the thermostat call for cooling is satisfied or turned to the off position, the compressor and outdoor fan motor are de-energized and the indoor blower motor continues to operate for an additional 30 – 45 seconds to extract the residual cooling from the cold indoor coil.

7.0 COMPONENTS & CONTROLS

7.1 Compressor

Scroll compressors are used in all models.

7.2 Fan Motor

Most (-)A13NZ and (-)A14AZ condensing units are equipped with a standard PSC motor, but a few models utilize a high efficiency single-speed ECM motor.

7.3 Outdoor Fan

All models utilize a standard paddle 2 or 3 blade fan made from either aluminum or coated steel.

7.4 Compressor Contactor

All single-phase models utilize a single-pole contactor to power the compressor and fan motor. Field power is connected directly to the terminal lugs on the line side of the contactor.

7.5 Compressor/Fan Motor Capacitor

Single-phase models with PSC fan motors utilize a dual capacitor for both the compressor and fan motor. Single-phase models with ECM outdoor motors utilize a single capacitor for the compressor.

7.6 Compressor Crankcase Heat (CCH)

While scroll compressors usually do not require crankcase heaters, there are instances when a heater should be added. Refrigerant migration during the off cycle can result in a noisy start up. Add a crankcase heater to minimize refrigerant migration and to help eliminate any start up noise or bearing “wash out.”

NOTE: A crankcase heater should be installed if:

- The system charge exceeds the values listed in the adjacent tables,
- The system is subject to low voltage variations, or
- When a low ambient control is used for system operation below 55°F [12.8 °C].

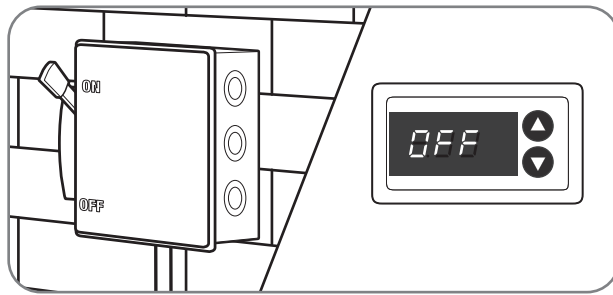

All heaters are located on the lower half of the compressor shell. Its purpose is to drive refrigerant from the compressor shell during long off cycles, thus preventing damage to the compressor during start-up.

At initial start-up or after extended shutdown periods, make sure the heater is energized for at least 12 hours before the compressor is started. (Disconnect switch is on and wall thermostat is off.)

Maximum System Charge Values		
Size	Charge Limit Without Crankcase Heater	
	Copeland	LG
18	9.6 lbs [4.4 kg]	8.4 lbs [3.81 kg]
24		
30		
36		
42	12.0 lbs [5.4 kg]	
48		
60*		

* 13.4 and 14.3/13.8 SEER2 5 ton models have factory installed crankcase heaters.

7.0 COMPONENTS & CONTROLS

7.7 High- and Low-Pressure Controls (HPC and LPC)

HPC and LPC are not factory installed on (-)A*****J1NA models, but can be field installed using the following kits:

RXAB-A08 (High Pressure Control)

RXAC-A10 (Low Pressure Control)

These controls keep the compressor from operating in pressure ranges which can cause damage to the compressor. Both controls are in the low-voltage control circuit.

HPC and LPC are factory installed on all

(-)A*****J1NALHP models.

The high-pressure control (HPC) is an automatic-reset which opens near 610 PSIG [4206 kPa] and closes near 420 PSIG [2896 kPa].

The low-pressure control (LPC) is an automatic-reset which opens near 50 PSIG [345 kPa] and closes near 95 PSIG [655 kPa].

⚠CAUTION: The compressor has an internal overload protector. Under some conditions, it can take up to 2 hours for this overload to reset. Make sure overload has had time to reset before condemning the compressor.

7.8 Compressor Hard Start Components

Start components are not usually required with the scroll compressors used in heat pumps, but are available for special cases and where start components are desirable to reduce light dimming.

Hard start components must be field installed and are available through manufacturer's parts department.

8.0 ACCESSORIES

⚠WARNING: Turn off electric power at the fuse box or service panel before making any electrical connections while installing accessories. Failure to do so can result in electrical shock, severe personal injury, or death.

⚠CAUTION:
SINGLE POLE COMPRESSOR CONTACTOR (CC):

Single pole contactors are used on all single-phase units. Caution must be exercised when servicing as only one leg of the power supply is broken with the contactor.

8.1 Compressor Time Delay

The time delay (TDC) is in the low voltage control circuit. When the compressor shuts off due to a power failure or thermostat operation, this control keeps it off at least 5 minutes before the next cycle can begin.

8.2 High Pressure Control

1.5 – 5 Ton Models: RXAB-A08

Note: Units with model numbers ending in “LHP” have a factory installed high pressure control.

8.3 Low Pressure Control

1.5 – 5 Ton Models: RXAC-A10

Note: Units with model numbers ending in “LHP” have a factory installed low pressure control.

8.4 Low Ambient Control

This component senses compressor head pressure and shuts the outdoor fan off when the head pressure drops to approximately 250 PSIG. This allows the unit to build a sufficient head pressure at lower outdoor ambient (down to 0°F

[-18°C]) in order to maintain system balance and capacity. Low ambient control should be used on all equipment frequently operated below 70°F [21°C] ambient. Part No. **RXAD-A08**

8.5 Compressor Hard Start Kit

1.5–5.0 Ton 208/230V Single Phase Models:
Part No. **SK-A1**

8.6 Compressor Crankcase Heater

1.5–3.0 Ton 208/230V Single and 3-Phase Models: Part No. **44-101884-08** (w/outdoor temp. thermostat) or **44-17402-44** (w/o outdoor temp. thermostat)

3.5–5.0 Ton 208/230V Single and 3-Phase Models: Part No. **44-103663-13** (w/outdoor temp. thermostat) or **44-17402-45** (w/o outdoor temp. thermostat)

8.7 Compressor Sound Enclosure

1.5–3.0 Ton Models:
Part No. **68-23427-26**

3.5–5.0 Ton Models:
Part No. **68-23427-25**

9.0 DIAGNOSTICS & TROUBLESHOOTING

9.1 Cooling Mechanical Checks Flowchart

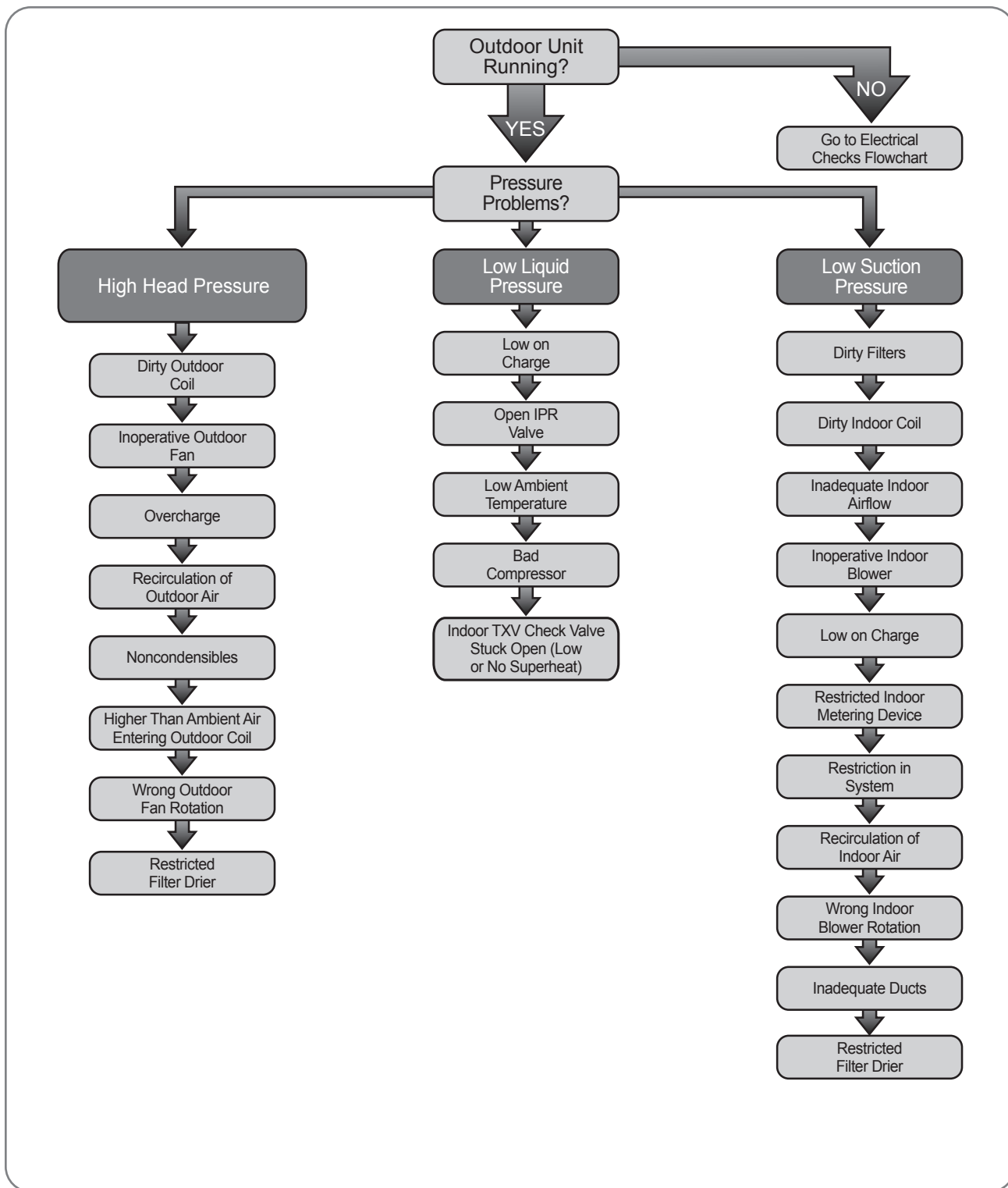

9.0 DIAGNOSTICS & TROUBLESHOOTING

9.2 General Troubleshooting Guide

⚠ WARNING: Disconnect all power to unit before servicing. Contactor may break only one side. Failure to shut off power can cause electrical shock resulting in personal injury or death.

Diagnostics

SYMPTOM	POSSIBLE CAUSE	REMEDY
Unit will not run	<ul style="list-style-type: none"> Power off or loose electrical connection Thermostat out of calibration – set too low or high Defective control board Blown fuses/tripped breaker Transformer defective High-pressure control open Low pressure control open Miswiring of thermostat 	<ul style="list-style-type: none"> Check for correct voltage at line voltage connections in condensing unit. Reset. Check control board diagnostic codes. Replace fuses/reset breaker. Check wiring. Replace transformer. See high head pressure or low suction pressure remedies. Low refrigerant charge due to leak. Check refrigerant charge and check for leaks. Check thermostat wiring.
Outdoor fan runs, compressor doesn't	<ul style="list-style-type: none"> Run or start capacitor defective Start relay defective Loose connection Compressor stuck, grounded or open motor winding, open internal overload. Low-voltage condition 	<ul style="list-style-type: none"> Replace. Replace. Check for correct voltage at compressor. Check and tighten all connections. Wait at least 3 hours for overload to reset. If still open, replace the compressor. Add start kit components.
Insufficient cooling	<ul style="list-style-type: none"> Improperly sized unit Improper indoor airflow Incorrect refrigerant charge Air, noncondensibles, or moisture in system Restricted refrigerant circuit 	<ul style="list-style-type: none"> Recalculate load. Check. Should be approximately 400 CFM [189 L/s] per ton. Charge per procedure attached to unit service panel. Recover refrigerant. Evacuate and recharge. Add or replace filter drier. Locate restriction and clear.
Compressor short cycles	<ul style="list-style-type: none"> Incorrect voltage Defective overload protector Refrigerant undercharge or overcharge (HPC or LPC cycling) 	<ul style="list-style-type: none"> At compressor terminals, voltage must be $\pm 10\%$ of nameplate marking when unit is operating. Replace compressor. Check for correct voltage. Adjust charge per charging chart.
Registers sweat	<ul style="list-style-type: none"> Low indoor airflow 	<ul style="list-style-type: none"> Increase speed of blower or reduce restriction. Replace air filter.
High head, low suction pressures	<ul style="list-style-type: none"> Restriction in liquid line, expansion device, or filter drier Bad TXV 	<ul style="list-style-type: none"> Remove or replace defective component. Replace TXV.
High head, high or normal suction pressure	<ul style="list-style-type: none"> Dirty outdoor coil Refrigerant overcharge Outdoor fan not running Air or noncondensibles in system 	<ul style="list-style-type: none"> Clean coil. Correct system charge. Repair or replace. Recover refrigerant. Evacuate and recharge.
Low head, high vapor pressures	<ul style="list-style-type: none"> Bad TXV Bad compressor 	<ul style="list-style-type: none"> Replace TXV. Replace compressor.
Low suction pressure, iced indoor coil	<ul style="list-style-type: none"> Low indoor airflow Operating below 65°F [18°C] outdoors Moisture in system Low refrigerant charge 	<ul style="list-style-type: none"> Increase speed of blower or reduce restriction. Replace air filter. Add Low Ambient Kit. Recover refrigerant. Evacuate and recharge. Add filter drier. Check refrigerant charge and check for leaks.
High suction pressure	<ul style="list-style-type: none"> Excessive load Defective compressor 	<ul style="list-style-type: none"> Recheck load calculation. Replace.
Fluctuating head and suction pressures	<ul style="list-style-type: none"> TXV hunting Air or noncondensibles in system 	<ul style="list-style-type: none"> Check TXV bulb clamp. Check air distribution on coil. Replace TXV. Recover refrigerant. Evacuate and recharge.
Gurgle or pulsing noise at expansion device or liquid line	<ul style="list-style-type: none"> Air or noncondensibles in system Undercharged system 	<ul style="list-style-type: none"> Recover refrigerant. Evacuate and recharge. Adjust charge per charging chart.

9.0 DIAGNOSTICS & TROUBLESHOOTING

9.3 Service Analyzer Charts

COMPRESSOR OVERHEATING			
SYMPTOM	POSSIBLE CAUSE	CHECK/REMEDY	
High superheat (greater than 15°F [8.3°C] at coil)	Low charge	Check system charge.	
	Faulty metering device	Restricted cap tube, TXV	
		Power element superheat out of adjustment internally	
		Foreign matter stopping flow	
	High internal load	Hot air (attic) entering return	
		Heat source on; miswired or faulty control	
	Restriction in liquid line	Drier plugged.	
		Line kinked.	
	Low head pressure	Low charge	
		Operating in low ambient temperatures	
Suction or liquid line subjected to high heat source	Hot attic		
	Hot water line		
Low line voltage	Loose wire connections	Check wiring.	
	Power company problem, transformer	Report Problem.	
	Undersized wire feeding unit	Correct and complete diagnosis.	
High line voltage	Power company problem	Report Problem.	
High head pressure	Overcharge	Check system charge.	
	Dirty outdoor coil	Clean coil.	
	Faulty or wrong size outdoor fan motor	Replace fan motor. Check capacitor.	
		Replace fan blade.	
	Faulty fan blade or wrong rotation	Replace with correct rotation motor.	
		Correct installation.	
	Recirculation of air	Correct installation.	
	Additional heat source	Check for dryer vent near unit.	
Check for recirculation from other equipment.			
Noncondensibles	Recover refrigerant. Evacuate and recharge system.		
Equipment not matched	Correct mismatch.		
Short cycling of compressor	Cycling or faulty pressure control	Check pressures and address cause of high or low pressure. Replace pressure control if faulty.	
	Loose wiring	Check unit wiring.	
	Thermostat	Located in supply air stream	
		Differential setting too close	
		Customer misuse	
	Indoor coil TXV Restricted	Internal foreign matter	
		Power element failure	
		TXV too small	
		Equilizer tube plugged	
	Indoor coil distributor tube restricted	Restricted with foreign matter	
		Kinked	
		Inside diameter reduced from previous compressor failure	

9.0 DIAGNOSTICS & TROUBLESHOOTING

9.3 Service Analyzer Charts (cont.)

Diagnostics

COMPRESSOR OVERHEATING (cont.)		
SYMPTOM	POSSIBLE CAUSE	CHECK OR REMEDIES
Short cycling of compressor (cont.)	Low charge	Check system charge.
	Low evaporator airflow	Dirty coil
		Dirty filter
		Duct too small or restricted
	Faulty run capacitor	Replace.
Faulty internal overload	Replace compressor.	
Faulty Compressor Valves or scrolls	Fast equalization/Low pressure difference	Replace compressor and examine system to locate reason.
ELECTRICAL		
SYMPTOM	POSSIBLE CAUSE	CHECK OR REMEDIES
Voltage present on load side of compressor contactor and compressor won't run	Compressor start components	Check start capacitor.
		Check potential relay.
	Run capacitor	Check with ohmmeter
	Internal overload	Allow time to reset.
Voltage present on line side of compressor contactor only	Compressor windings	Check for correct ohms.
	Thermostat	Check for control voltage to contactor coil.
	Compressor control circuit	High-pressure switch
		Low-pressure switch
		Ambient thermostat
Solid-state protection control or internal thermal sensors		
Compressor timed off/on control or interlock		
No voltage on line side of compressor contactor	Blown fuses or tripped circuit breaker	Check for short in wiring or unit.
	Improper wiring	Recheck wiring diagram.
Improper voltage	High voltage	Wrong unit
		Power supply problem
	Low voltage	Wrong unit
		Power supply problem
		Wiring undersized
	Loose connections	
Single Phasing (3 phase)	Check incoming power and fusing.	
FLOODED STARTS		
SYMPTOM	POSSIBLE CAUSE	CHECK OR REMEDIES
Liquid in the compressor shell	Faulty or missing crankcase heater	Replace or add crankcase heater.
Too much liquid in system	Incorrect piping	Check piping guidelines.
	Overcharge	Check and adjust charge.

9.0 DIAGNOSTICS & TROUBLESHOOTING

9.3 Service Analyzer Charts (cont.)

CONTAMINATION		
SYMPTOM	POSSIBLE CAUSE	REMEDY
Moisture	Poor evacuation on installation or during service	In each case, the cure is the same. Recover refrigerant. Add filter drier, evacuate, and recharge.
High head pressure	Noncondensibles air	
Unusual head and suction readings	Wrong refrigerant or mixed refrigerants	
Foreign matter – copper filings	Copper tubing cuttings	
Copper oxide	Dirty copper piping or nitrogen not used when brazing	
Welding scale	Nitrogen not used during brazing	
Soldering flux	Adding flux before seating copper partway	
Excess soft solder	Wrong solder material	
LOSS OF LUBRICATION		
SYMPTOM	POSSIBLE CAUSE	REMEDY
Compressor failures	Vapor line tubing too large	Reduce pipe size to improve oil return.
Low suction pressure	Low charge	Check system charge.
	Refrigerant leaks	Repair and recharge.
Cold, noisy compressor – Slugging	Dilution of oil with refrigerant	Observe piping guidelines.
Noisy compressor	Refrigerant migration in off-cycle	Check or add crankcase heater.
Cold, sweating compressor	Flooding	Check system charge.
Low load	Reduced indoor airflow	Dirty filter
		Dirty indoor coil
		Wrong duct size
	Restricted duct	
	Thermostat setting	Advise customer.
Short cycling of compressor	Cycling or faulty high- or low-pressure control	Check pressures and address cause of high or low pressure. Replace control if faulty.
	Loose wiring	Check all control wires.
	Thermostat	In supply air stream, out of calibration
		Customer misuse
SLUGGING		
SYMPTOM	POSSIBLE CAUSE	REMEDY
On start-up	Incorrect piping	Review pipe size guidelines.
TXV hunting when running	Faulty indoor TXV	Replace TXV.

9.0 DIAGNOSTICS & TROUBLESHOOTING

9.3 Service Analyzer Charts (cont.)

Diagnostics

FLOODING			
SYMPTOM	POSSIBLE CAUSE	REMEDY	
Poor system control using a TXV	Loose sensing bulb	Secure the bulb and insulate.	
	Bulb in wrong location	Relocate bulb.	
	Wrong size TXV	Use correct replacement.	
	Improper superheat setting (less than 5°F [2.8°C])	Replace TXV.	
THERMOSTATIC EXPANSION VALVE (TXV)			
SYMPTOM	POSSIBLE CAUSE	REMEDY	
High Superheat, Low Suction Pressure (superheat over 15°F [8.3°C])	Moisture freezing and blocking valve	Recover charge, install filter-drier, evacuate system, recharge.	
	Dirt or foreign material blocking valve	Recover charge, install filter-drier, evacuate system, recharge.	
	Low refrigerant charge	Correct the charge.	
	Vapor bubbles in liquid line		Remove restriction in liquid line. Correct the refrigerant charge.
			Remove noncondensable gases.
			Size liquid line correctly.
	Misapplication of internally equalized valve	Use correct TXV.	
	Plugged external equalizer line	Remove external equalizer line restriction.	
	Undersized TXV	Replace with correct valve.	
	Loss of charge from power head sensing bulb	Replace power head or complete TXV.	
Charge migration from sensing bulb to power head (Warm power head with warm, wet cloth. Does valve operate correctly now?)	Ensure TXV is warmer than sensing bulb.		
Valve feeds too much refrigerant, with low superheat and higher than normal suction pressure	Moisture causing valve to stick open.	Recover refrigerant, replace filter-drier, evacuate system, and recharge.	
	Dirt or foreign material causing valve to stick open	Recover refrigerant, replace filter drier, evacuate system, and recharge.	
	TXV seat leak (a gurgling or hissing sound is heard AT THE TXV during the off cycle, if this is the cause). NOT APPLICABLE TO BLEED PORT VALVES.	Replace the TXV.	
	Oversized TXV	Install correct TXV.	
	Incorrect sensing bulb location	Install bulb with two mounting straps, in 2:00 or 4:00 position on suction line, with insulation.	
	Low superheat adjustment	Replace TXV.	
	Incorrectly installed, or restricted external equalizer line	Remove restriction, or relocate external equalizer.	

9.0 DIAGNOSTICS & TROUBLESHOOTING

9.3 Service Analyzer Charts (cont.)

THERMOSTATIC EXPANSION VALVES (cont.)		
SYMPTOM	POSSIBLE CAUSE	REMEDY
Compressor flood back upon start-up	Refrigerant drainage from flooded evaporator	Install trap riser to the top of the evaporator coil.
	Inoperable crankcase heater or crankcase heater needed	Replace or add crankcase heater.
Superheat is low to normal with low suction pressure	Unequal evaporator circuit loading	Ensure airflow is equally distributed through evaporator.
		Check for blocked distributor tubes.
	Low load or airflow entering evaporator coil	Ensure blower is moving proper air-flow.
		Remove/Correct any airflow restriction.
Superheat and suction pressure fluctuate (valve is hunting)	TXV is oversized	Install correct TXV.
	Sensing bulb is affected by liquid refrigerant or refrigerant oil flowing through suction line	Relocate sensing bulb in another position around the circumference of the suction line.
	Unequal refrigerant flow through evaporator circuits	Ensure sensing bulb is located properly.
		Check for blocked distributor tubes.
Moisture freezing and partially blocking TXV	Recover refrigerant, change filter-drier, evacuate system, and recharge.	
Valve does not regulate at all	External equalizer line not connected or line plugged	Connect equalizer line in proper location, or remove any blockage.
	Sensing bulb lost its operating charge	Replace TXV.
	Valve body damaged during soldering or by improper installation	Replace TXV.

9.0 DIAGNOSTICS & TROUBLESHOOTING

9.4 Troubleshooting Tips

Diagnostics

COOLING MODE TROUBLESHOOTING TIPS					
SYSTEM PROBLEM	INDICATORS				
	DISCHARGE PRESSURE	SUCTION PRESSURE	SUPERHEAT Normal: 5°–15°F [2.8° – 8.3°C]	SUBCOOLING Normal: See Charging Chart	COMPRESSOR AMPS
Overcharge	High	High	Low	High	High
Undercharge	Low	Low	High	Low	Low
Liquid Restriction (Filter Drier)	Low	Low	High	High	Low
Low Indoor Airflow	Low	Low	Low	Low	Low
Dirty Outdoor Coil	High	High	Low	Low	High
Low Outdoor Ambient Temperature	Low	Low	High	High	Low
Inefficient Compressor	Low	High	High	High	Low
Indoor TXV Sensing Bulb Charge Lost	Low	Low	High	High	Low
Poorly Insulated Indoor Sensing Bulb	High	High	Low	Low	High

10.0 OUTDOOR UNIT MAINTENANCE



10.1 Outdoor Coil Cleaning

The outdoor fan draws air across the coil during operation which results in contaminants collecting on and between the aluminum fins. These contaminants restrict the air-flow through the coil resulting in reduced capacity and efficiency and increases the temperature of the components that can reduce their life. Therefore, it is recommended that the outdoor coil be cleaned at least annually by a qualified service technician using a non-corrosive coil cleaner and low pressure water hose sprayer. Care must be taken not to damage or flatten out the fins by spraying the fins from

an angle. Washing from the top of the coil down from the inside out is the most effective method of cleaning the coil. The exterior louver panels and unit top are easily removable to facilitate the coil cleaning task.

WARNING: Disconnect electrical power to the unit before removing the top panel or any electrical panel as the fan motor could start at any time and live electrical connections will be exposed.



10.2 Cabinet Cleaning and Care

Annual cleaning of the exterior cabinet is recommended using a mild detergent, water, and cloth/sponge to remove dust, mold, and potentially corrosive contaminants that have collected on the cabinet. It is also recommended to apply a good quality automotive wax to the painted metal cabinet parts annually to protect the finish and to restore the gloss of the paint. Do not apply wax to the plastic parts.



10.3 Motor Lubrication

The bearings in the outdoor motor are pre-lubricated by the motor manufacturer and do not have oiling ports. The motor will run for an indefinite period of time without additional lubrication.



10.4 Replacement Parts

Any replacement part used to replace parts originally supplied on equipment must be the same as or an approved alternate to the original part supplied. The manufacturer will not be responsible for replacement parts not designed to physically fit or operate within the design parameters the original parts were selected for.

11.0 WIRING DIAGRAMS

11.1 For Single-Phase Models with PSC Motor

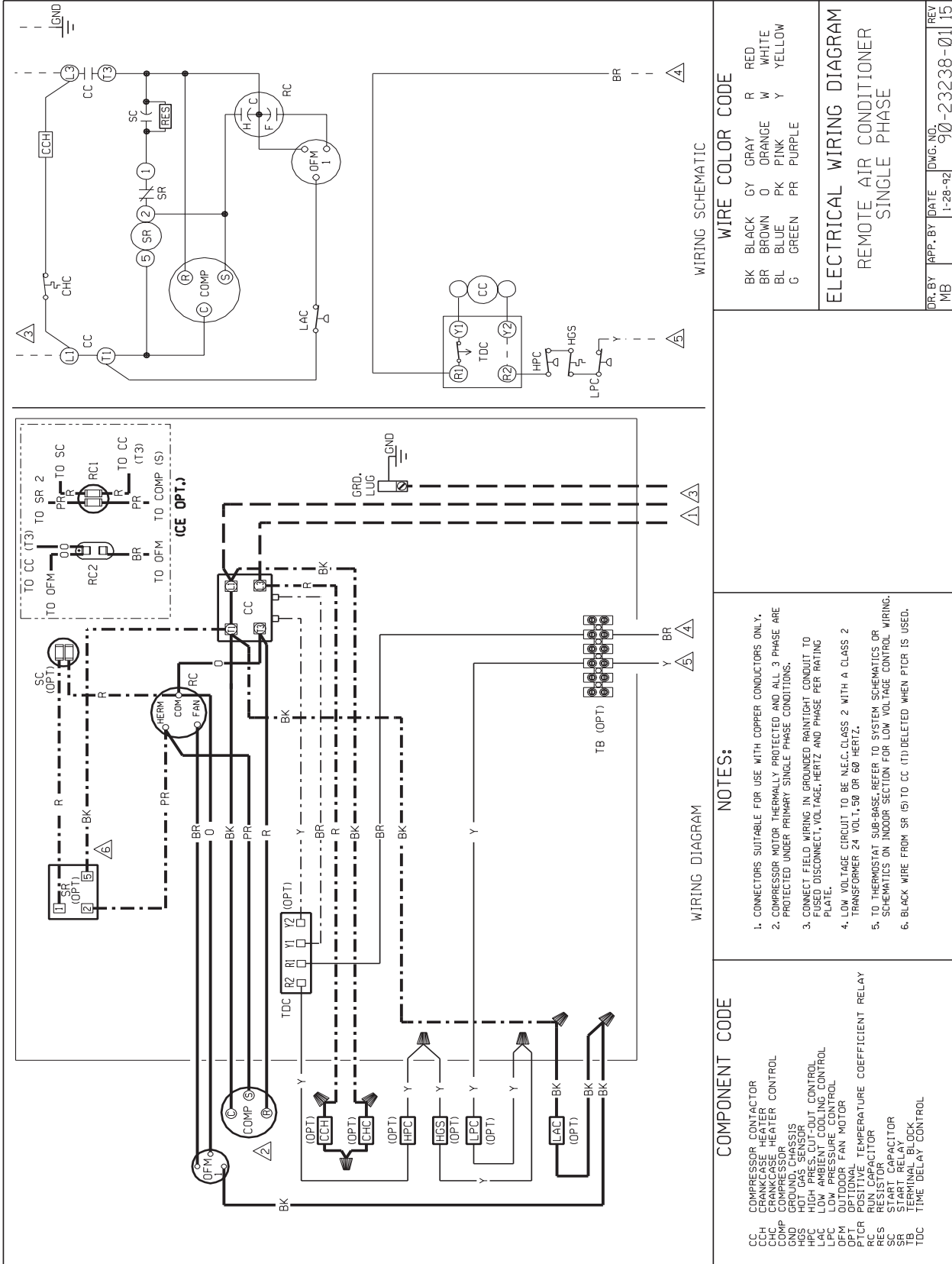

11.0 WIRING DIAGRAMS

11.2 For Single-Phase Models with ECM Motor

