

# Use & Care Manual

With Installation Instructions for the Installer

Electric Residential Hybrid

# Water Heaters

Residential - HB Series

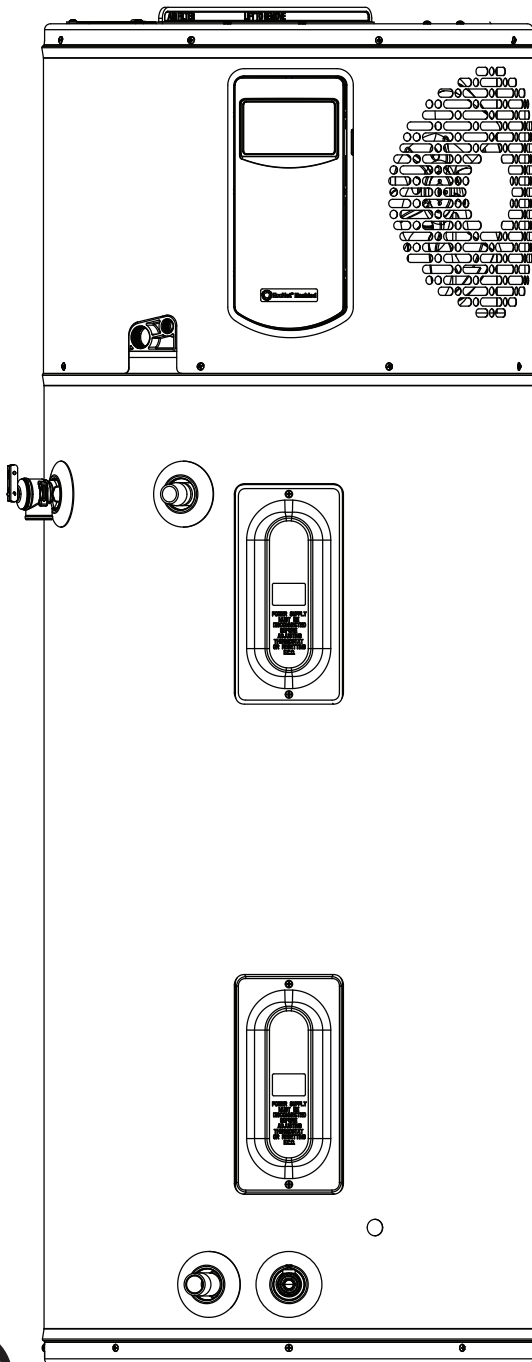



The purpose of this manual is twofold: one, to provide the installer with the basic directions and recommendations for the proper installation and adjustment of the water heater; and two, for the owner-operator, to explain the features, operation, safety precautions, maintenance and troubleshooting of the water heater. This manual also includes a parts list.

It is imperative that all persons who are expected to install, operate or adjust this water heater read the instructions carefully so they may understand how to perform these operations. If you do not understand these instructions or any terms within it, seek professional advice.

Any questions regarding the operation, maintenance, service or warranty of this water heater should be directed to the seller from whom it was purchased. If additional information is required, refer to the section on "If you need service."

**DO NOT destroy this manual. Please read carefully and keep in a safe place for future reference.**

 **Recognize this symbol as an indication of Important Safety Information!**

 **California Proposition 65 Warning:** This product contains chemicals known to the State of California to cause cancer, birth defects or other reproductive harm.



## Safety Information

Safety Precautions . . . . . 3-4

## Installation Instructions

Location . . . . . 5

Water Connections . . . . . 6

Condensate Drain . . . . . 6

Relief Valve . . . . . 7

Electrical Connections . . . . . 9

Pipe Insulation . . . . . 10

Installation Checklist . . . . . 11

## Operating Instructions

Safety Controls . . . . . 12

Water Temperature . . . . . 12

Basic Water Heater Operation . . . . . 13-15

## Care and Cleaning

Draining . . . . . 16

Maintenance . . . . . 16

Extended Shut-Down . . . . . 17

## Troubleshooting Tips

Before You Call  
For Service . . . . . 18-20

## Customer Service

Parts List . . . . . 21

Wiring Diagram . . . . . 23

If You Need  
Service . . . . . 24



## FOR YOUR RECORDS

Write the model and serial numbers here:

# \_\_\_\_\_

# \_\_\_\_\_

You can find them on a label on the appliance.

Staple sales slip or cancelled check here.

Proof of the original purchase date is needed to obtain service under the warranty.



## READ THIS MANUAL

Inside you will find many helpful hints on how to use and maintain your water heater properly. Just a little preventive care on your part can save you a great deal of time and money over the life of your water heater.

You'll find many answers to common problems in the Before You Call For Service section. If you review our chart of Troubleshooting Tips first, you may not need to call for service at all.



## READ THE SAFETY INFORMATION

**Your safety and the safety of others are very important. There are many important safety messages in this manual and on your appliance. Always read and obey all safety messages.**



**This is the safety alert symbol. Recognize this symbol as an indication of Important Safety Information!**

**This symbol alerts you to potential hazards that can kill or hurt you and others.**

All safety messages will follow the safety alert symbol and either the word "DANGER", "WARNING", "CAUTION" or "NOTICE".

These words mean:

**⚠ DANGER**

An imminently hazardous situation that will result in death or serious injury.

**⚠ WARNING**

A potentially hazardous situation that could result in death or serious injury and/or damage to property.

**⚠ CAUTION**

A potentially hazardous situation that may result in minor or moderate injury.

**NOTICE:**

Attention is called to observe a specified procedure or maintain a specific condition.

# IMPORTANT SAFETY INFORMATION. READ ALL INSTRUCTIONS BEFORE USING.

## **⚠ DANGER!**

### **WATER TEMPERATURE SETTING**



Safety and energy conservation are factors to be considered when selecting the water temperature setting of water heater. Water temperatures above 125°F can cause severe burns or death from scalding. Be sure to read and follow the warnings outlined on the label pictured below. This label is also located on the water heater near the thermistor access panel.

⚠ DANGER

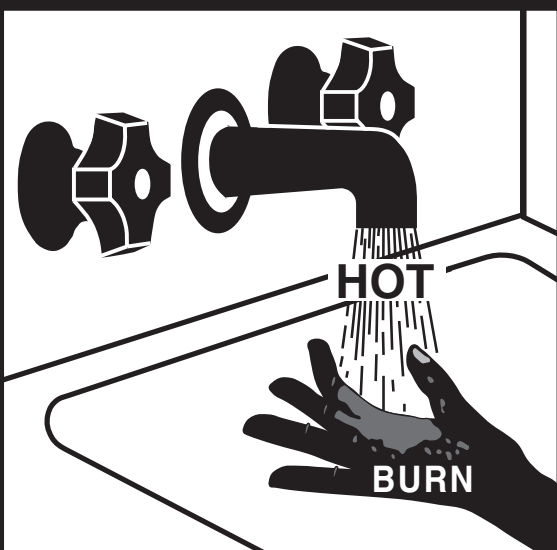

**Water temperature over 125°F can cause severe burns instantly or death from scalds.**

**Children, disabled and elderly are at highest risk of being scalded.**

**See instruction manual before setting temperature at water heater.**

**Feel water before bathing or showering.**

**Temperature limiting valves are available, see manual.**

### **Time/Temperature Relationship in Scalds**

Temperature	Time To Produce a Serious Burn
120°F (49°C)	More than 5 minutes
125°F (52°C)	1½ to 2 minutes
130°F (54°C)	About 30 seconds
135°F (57°C)	About 10 seconds
140°F (60°C)	Less than 5 seconds
145°F (63°C)	Less than 3 seconds
150°F (65°C)	About 1½ seconds
155°F (68°C)	About 1 second

Table courtesy of Shriners Burn Institute

The chart shown above may be used as a guide in determining the proper water temperature for your home.

**⚠ DANGER: Households with small children, disabled, or elderly persons may require a 120°F or lower thermostat setting to prevent contact with “HOT” water.**

The temperature of the water in the heater is regulated by the water heater interface control. To comply with safety regulations the temperature was set at 120°F before the water heater was shipped from the factory.

The illustration below shows the water temperature setting.

Refer to the Operating Instructions in this manual for detailed instructions in how to adjust the water temperature.



**⚠ DANGER: Hotter water increases the potential for Hot Water SCALDS.**

Notice: Mixing valves are recommended for reducing point of use water temperature by mixing hot and cold water in branch water lines. It is recommended that a mixing valve complying with the Standard for Temperature Actuated Mixing Valves for Hot Water Distribution Systems, ASSE 1017 be installed. See page 12 for more details and contact a licensed plumber or the local plumbing authority for further information.

# IMPORTANT SAFETY INFORMATION. READ ALL INSTRUCTIONS BEFORE USING.

---

## **WARNING!**

For your safety, the information in this manual must be followed to minimize the risk of fire or explosion, electric shock, or to prevent property damage, personal injury, or loss of life.

Be sure to read and understand the entire Use and Care Manual before attempting to install or operate this water heater. It may save you time and cost. Pay particular attention to the Safety Instructions. Failure to follow these warnings could result in serious bodily injury or death. Should you have problems understanding the instructions in this manual, or have any questions, STOP, and get help from a qualified service technician, or the local electric utility.



## FOR INSTALLATIONS IN THE STATE OF CALIFORNIA

---

California Law requires that residential water heaters must be braced, anchored or strapped to resist falling or horizontal displacement due to earthquake motions. For residential water heaters up to 52-gallon capacity, a brochure with generic earthquake bracing instructions can be obtained from: Office of the State Architect, 1102 Q Street, Suite 5100, Sacramento, CA 95814 or you may call 916-445-8100 or ask a water heater dealer.

However, applicable local codes shall govern installation. For residential water heaters of a capacity greater than 52 gallons, consult the local building jurisdiction for acceptable bracing procedures.



## SAFETY PRECAUTIONS

---

Have the installer show you the location of the circuit breaker and how to shut it off if necessary. Turn off the circuit breaker if the water heater has been subjected to overheating, fire, flood, physical damage or if the ECO (temperature limiting control) fails to shut off.

- Read this manual entirely before installing or operating the water heater.
- Use this appliance only for its intended purpose as described in this Use and Care Manual.
- Be sure your appliance is properly installed in accordance with local codes and the provided installation instructions.
- **DO NOT** attempt to repair or replace any part of your water heater unless it is specifically recommended in this manual. All other servicing should be referred to a qualified technician.
- **DO NOT** turn on the electrical supply or operate this water heater unless it is completely full of water.

## **WARNING!**

Disconnect all power to unit before starting maintenance. Failure to do so can cause electrical shock resulting in severe personal injury or death.



READ AND FOLLOW THIS SAFETY INFORMATION  
CAREFULLY.

---

**SAVE THESE INSTRUCTIONS**

# Installing the water heater

The location chosen for the water heater must take into consideration the following:

## Local Installation Regulations

This water heater must be installed in accordance with these instructions, local codes, utility codes, utility company requirements or, in the absence of local codes, the latest edition of the National Electrical Code. It is available from some local libraries or can be purchased from the National Fire Protection Association,

Batterymarch Park, Quincy, MA 02269 as booklet ANSI/NFPA 70.

Canadian installations should refer to CSA22.1, a copy can be purchased from the Canadian Standards Association, 5050 Spectrum Way, Mississauga, ONT L4W 5N6

## Location

Locate the water heater in a clean dry area as near as practical to the area of greatest heated water demand. Long un-insulated hot water lines can waste energy and water.

Place the water heater in such a manner that the thermistor and element access panels can be removed to permit inspection and servicing such as removal of elements or checking controls.

The water heater and water lines should be protected from freezing temperatures. **DO NOT** install the water heater in outdoor, unprotected areas.

Make certain the floor underneath the water heater is strong enough to sufficiently support the weight of the water heater once it is filled with water.

**▲CAUTION: The water heater should not be located in an area where leakage of the tank or connections will result in damage**

**to the area adjacent to it or to lower floors of the structure. Where such areas cannot be avoided, it is recommended that a suitable drain pan, adequately drained, be installed under the water heater.**

**NOTICE: Installation in a confined space will lead to higher power consumption if adequate ventilation is not provided.**

It is recommended that the hybrid water heater be installed in a location with a minimum of 1,000 cubic feet (10' x 10' x 10') of unconditioned air. To maintain high efficiencies in a space less than 1,000 cubic feet, a minimum of 250 cubic feet per minute of unconditioned air exchange is required. Insufficient air exchange will result in increased energy consumption levels.

Clearances	
Rear	Top
0"	6" Min.

**NOTICE: Auxiliary drain pan MUST conform to local codes.**

Drain Pan Kits are available from the store where the water heater was purchased, or any water heater distributor.

Drain Pan should not obstruct cold inlet or drain valve.

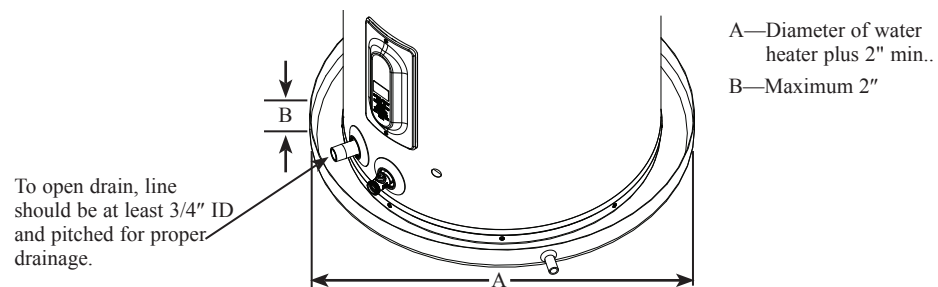

## Inspect Shipment

Inspect the water heater for possible damage. Check the markings on the rating plate of the water heater to be certain the power supply corresponds to the water heater requirements. Rating plate is located on front of water heater.

## Refrigerant

This Hybrid Water Heater is factory charged with an environmentally friendly, non-chlorinated refrigerant, R410A. This refrigerant has zero ozone depletion potential.

# Installing the water heater

---

## Thermal Expansion

**Determine if a check valve exists in the inlet water line. Check with your local water utility.** It may have been installed in the cold water line as a separate back flow preventer, or it may be part of a pressure reducing valve, water meter or water softener. A check valve located in the cold water inlet line can cause what is referred to as a “**closed water system**”. A cold water inlet line with no check valve or back flow prevention device is referred to as an “**open**” water system.

As water is heated, it expands in volume and creates an increase in the pressure within the water system. This action is referred to as “**thermal expansion**”. In an “**open**” water system, expanding water which exceeds the capacity of the water heater flows back into the city main where the pressure is easily dissipated.

A “**closed water system**”, however, prevents the expanding water from flowing back into the main supply line, and the result of “**thermal expansion**” can create a rapid and dangerous pressure increase in the

water heater and system piping. This rapid pressure increase can quickly reach the safety setting of the relief valve, causing it to operate during each heating cycle. Thermal expansion, and the resulting rapid and repeated expansion and contraction of components in the water heater and piping system can cause premature failure of the relief valve, and possibly the heater itself. Replacing the relief valve **WILL NOT** correct the problem!

The suggested method of controlling thermal expansion is to install an expansion tank in the cold water line between the water heater and the check valve (refer to the illustration on the next page). The expansion tank is designed with an air cushion built in that compresses as the system pressure increases, thereby relieving the over pressure condition and eliminating the repeated operation of the relief valve. Other methods of controlling thermal expansion are also available. Contact your installing contractor, water supplier or plumbing inspector for additional information regarding this subject.

---

## Water Supply Connections

Refer to the illustration on the next page for suggested typical installation. The installation of unions or flexible copper connectors is recommended on the hot and cold water connections so that the water heater may be easily disconnected for servicing if necessary. The **HOT** and **COLD** water connections are clearly marked and are 3/4" NPT on all models. Install a shut-off valve in the cold water line near the water heater.

**See page 8 on "To Fill The Water Heater".**

**NOTICE: DO NOT apply heat to the HOT or COLD water connections. If sweat connections are used, sweat tubing to adapter before fitting adapter to the water connections on heater. Any heat applied to the water supply fittings will permanently damage the dip tube and/or heat traps.**

---

## Condensate Drains

**Consult local codes or ordinances for specific requirements. Refer to page 7.**

**IMPORTANT:** When making drain fitting connections to the drain tubing, use a thin layer of piping tape or silicone and install hand tight.

**IMPORTANT:** When making drain fitting connections to the drain tubing, **DO NOT** overtighten. Overtightening fittings can split pipe connections on the drain pan.

- This unit is equipped with a 3/4" NPT female primary condensate connection and a 3/8" NPT female overflow connection. Use MIP fittings for connections.

- **DO NOT** reduce drain line size less than connection size provided on condensate drain.
- All drain lines must be pitched downward away from the unit a minimum of 1/8" per foot of line to ensure proper drainage.
- **DO NOT** connect condensate drain line to a closed or open sewer pipe. **DO NOT** allow condensate to drain into the water heater drain pan.
- The drain line should be insulated where necessary to prevent sweating and damage due to condensate forming on the outside surface of the line.



## Typical Installation

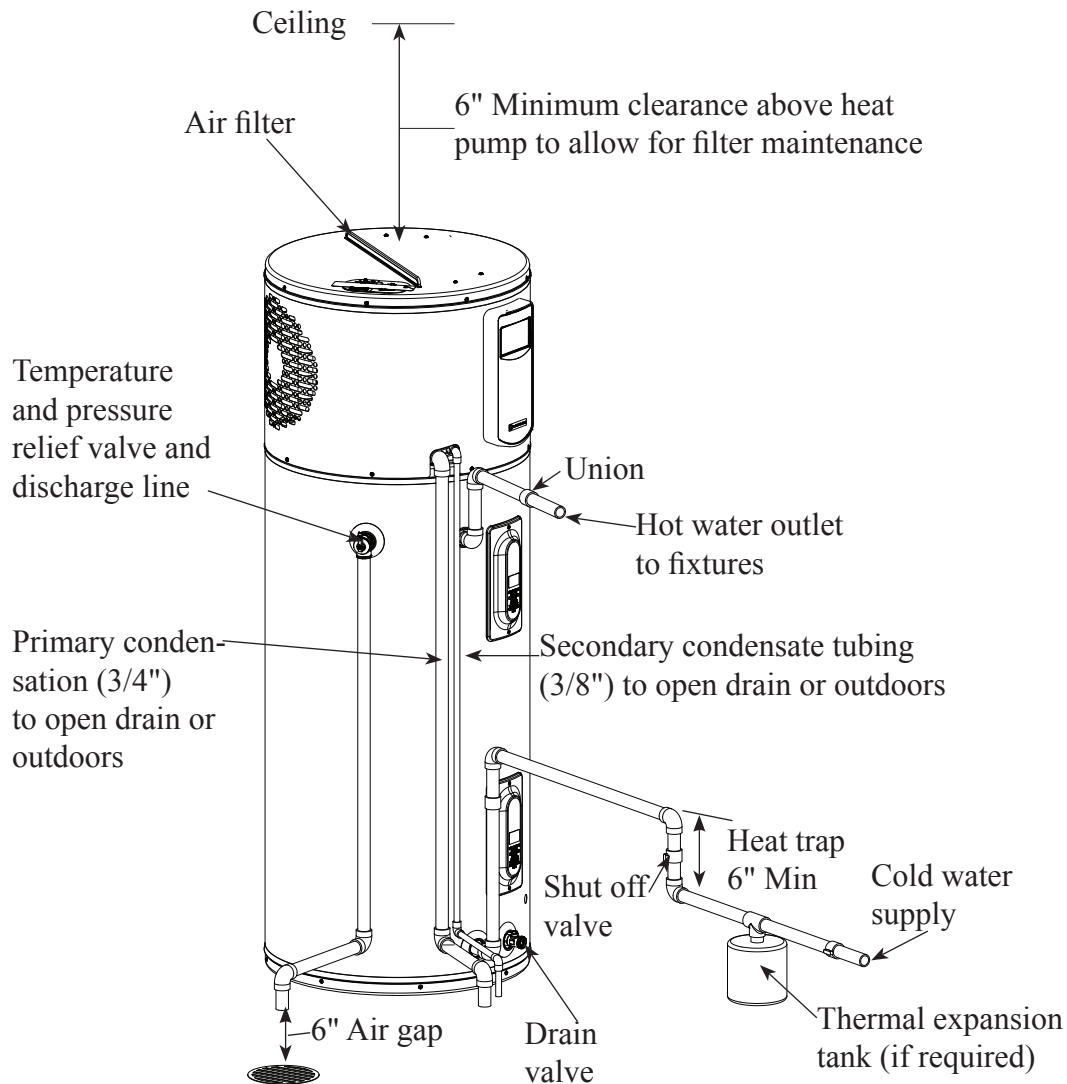

A new combination temperature and pressure relief valve, complying with the Standard for Relief Valves for Hot Water Supply Systems, ANSI Z21.22/CSA 4.4, is installed in the opening provided. No valve of any type should be installed between the relief valve and the tank. Local codes shall govern the installation of relief valves.

### Relief Valve

**▲WARNING:** The pressure rating of the relief valve must not exceed 150 PSI, the maximum working pressure of the water heater as marked on the rating plate.

The BTUH rating of the relief valve must not be less than the input rating of the water heater as indicated on the rating label located on the front of the heater (1 watt=3.412 BTUH).

Connect the outlet of the relief valve to a suitable open drain so that the discharge water cannot contact live electrical parts or persons and to eliminate potential water damage.

Piping used should be of a type

approved for hot water distribution. The discharge line must be no smaller than the outlet of the valve and must pitch downward from the valve to allow complete drainage (by gravity) of the relief valve and discharge line. The end of the discharge line should not be threaded or concealed and should be protected from freezing. No valve of any type, restriction or reducer coupling should be installed in the discharge line.

# Installing the water heater

**▲WARNING: DO NOT turn on the electrical supply or operate this water heater unless it is completely full of water. The tank must be full of water before water heater is turned on. The water heater warranty does not cover damage or failure resulting from operation with an empty or partially empty tank.**

## To Fill the Water Heater

Make certain the drain valve on the water heater is completely closed.

Open the shut-off valve in the cold water supply line.

Open each hot water faucet slowly to allow the air to vent from the water heater and piping.

A steady flow of water from the hot water faucet(s) indicates a full water heater.

## EcoNet™ Communication Port

EcoNet™ communication port is provided for integration with home automation, energy management, and demand response systems

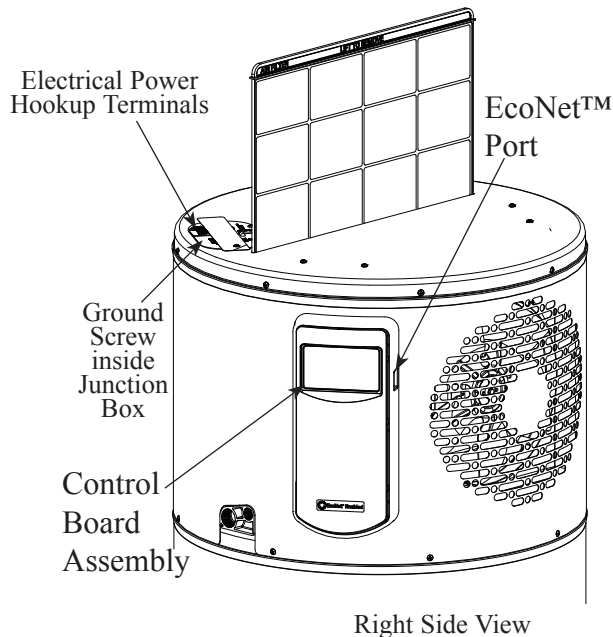

## Electrical Connections

**▲WARNING: Turn off electric power at the fuse box or service panel before making any electrical connections.**

Also, the ground connection must be completed before making line voltage connections. Failure to do so can result in electrical shock, severe personal injury or death.

Disconnect all power to unit before starting maintenance. Failure to do so can cause electrical shock resulting in severe personal injury or death

The unit must be grounded. Failure

to do so can cause electrical shock resulting in severe personal injury or death.

If the water heater has been subjected to fire, flood or physical damage, **DO NOT** operate the water heater again until it has been checked by a qualified service technician.

**NOTICE: DO NOT use this appliance if any part has been under water. Immediately call a qualified installer or service agency to replace a flooded water heater. DO NOT attempt to repair the unit! It must be replaced.**



## Electrical Connections continued...

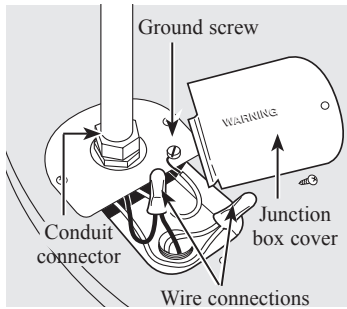

Water heater junction box.

**⚠ DO NOT** turn on the electrical supply or operate this water heater unless it is completely full of water.

A separate branch circuit with copper conductors, overcurrent protective device and suitable disconnecting means must be provided by a qualified electrician.

All wiring must conform to local codes or latest edition of National Electrical Code ANSI/NFPA 70.

The water heater is completely wired to the junction box inside jacket at the top front of the water heater. An opening for 1/2" or 3/4" electrical fitting is provided for field wiring connections.

The voltage requirements and wattage load for the water heater are specified on the rating plate on the front of the water heater.

The branch circuit wiring should include either:

- 1 Metallic conduit or metallic sheathed cable approved for use as a grounding conductor and installed with fittings approved for the purpose.
- 2 Non-metallic sheathed cable, metallic conduit or metallic sheathed cable not approved for use as a ground conductor shall include a separate conductor for grounding. It should be attached to the ground terminals of the water heater and the electrical distribution box.

**⚠ CAUTION:** The presence of water in the piping and water heater does not provide sufficient conduction for a ground. Non-metallic piping, dielectric unions, flexible connectors etc. can cause the water heater to be electrically isolated.

**⚠ WARNING:** If local codes require external application of insulation blanket kits the manufacturer's instructions included with the kit must be carefully followed.

## Insulation Blankets

Insulation blankets, available to the general public, for external use on electric water heaters are not necessary. The purpose of an insulation blanket is to reduce the standby heat loss encountered with storage tank heaters. This water heater meets or exceeds the National Appliance Energy Conservation Act standards with respect to insulation and standby loss requirements making an insulation blanket unnecessary.

The manufacturer's warranty does not cover any damage or defect caused by installation, attachment or use of any type of energy saving or other unapproved devices (other than those authorized by the manufacturer) into, onto or in conjunction with the water heater. The use of unauthorized energy saving devices may shorten the life of the water heater and may endanger life and property.

The manufacturer disclaims any responsibility for such loss or injury resulting from the use of such unauthorized devices.

**⚠ CAUTION:** If local codes require the application of an external insulation blanket to this water heater, pay careful attention to the following so as not to restrict the proper function and operation of the water heater:

- **DO NOT** cover the operating or warning labels attached to the water heater or attempt to relocate them on the exterior of insulation blanket.
- **DO NOT** cover air openings on both sides of the water heater .
- **DO NOT** cover the Controller Assembly, temperature and pressure relief valve or drain valve.
- Inspect the insulation blanket frequently.

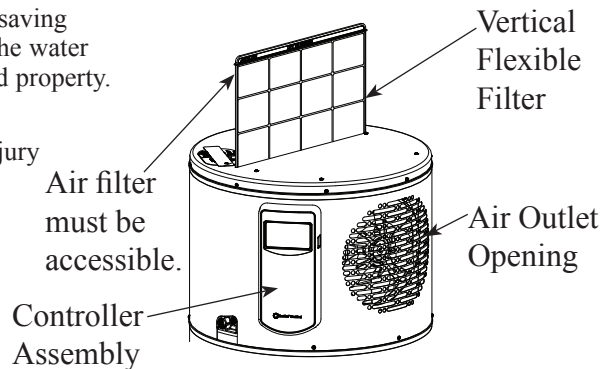

# Installing the water heater

## Hot and Cold Pipe Insulation Installation

Please install the insulation shown in the illustration. on the cold water supply inlet and the hot water outlet as

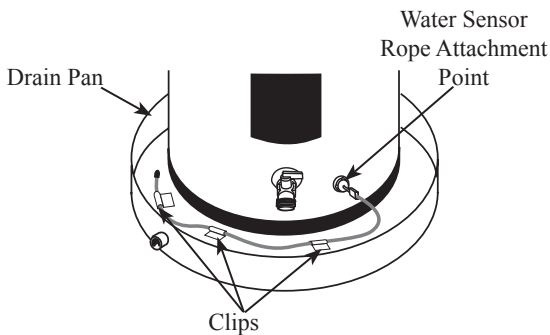
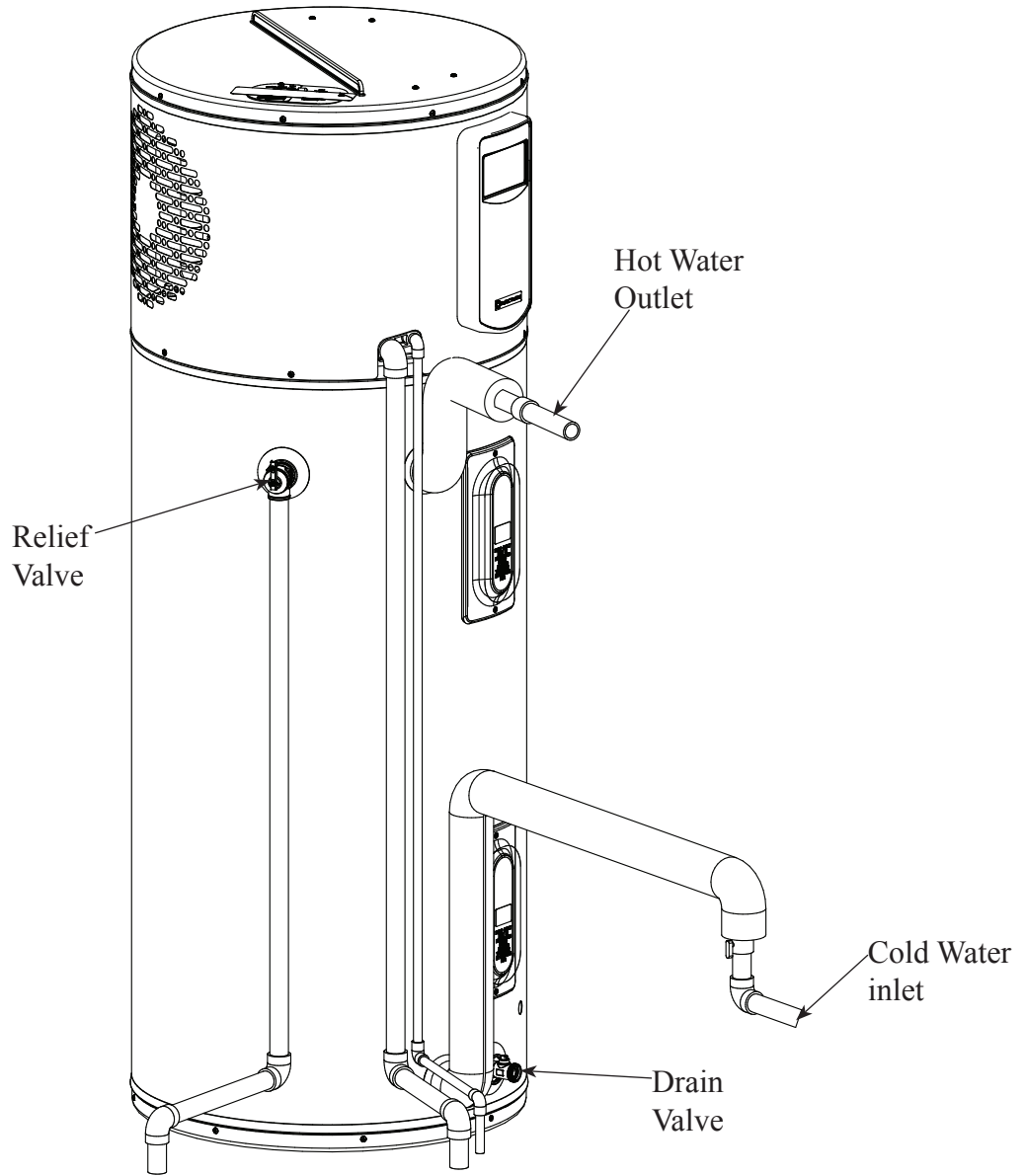

## Water Sensor

In order to detect the presence of unwanted water, this water heater is supplied with a built-in water sensing circuit. The water sensor rope is shipped in the warranty bag for field installation.

Remove water sensor rope from the bag and attach to the connector located near the lower access

panel. Place the rope in the recommended drain pan and secure to the pan bottom with provided self adhesive clips.

When water is detected, the electronic control will turn off the heating elements, flash the display backlight and turn on an audible alarm.

# Installation Checklist

---

## A. Water Heater Location

- Close to area of heated water demand.
  - Indoors and protected from moisture, wet conditions and freezing temperatures.
  - Area free of flammable vapors.
  - 1,000 cu. ft unconditioned indoor space.
  - Provisions made to protect area from water damage.
  - Sufficient room to service heater.
  - Six inches (6") of clearance from ceiling to top of Hybrid Water Heater to allow for filter maintenance.
  - Access to condensate disposal.
- 

## B. Water Supply

- Water heater completely filled with water.
  - Air purged from water heater and piping.
  - Water connections tight and free of leaks.
- 

## C. Relief Valve

- Temperature and Pressure Relief Valve properly installed and discharge line run to open drain.
  - Discharge line protected from freezing.
- 

## D. Wiring

- Power Supply voltage agrees with water heater rating plate.
  - Branch circuit wire and fusing or circuit breaker of proper size. (Recommended 30 amp breaker)
  - Electrical connections tight and unit properly grounded.
  - 10 gauge wire.
- 

## E. Condensate Lines

- Condensate lines from heat pump installed correctly.
- Condensate lines from heat pump run to a suitable drain location.

# Operating the water heater

---

**▲ CAUTION:** Hydrogen gas can be produced in a hot water system served by this water heater that has not been used for a long period of time (generally two weeks or more). **HYDROGEN GAS IS EXTREMELY FLAMMABLE!!** To dissipate such gas and to reduce risk of injury, it is recommended that the hot water faucet be opened for several minutes at the kitchen sink before using any electrical appliance connected to the hot water system. If hydrogen is present, there will be an unusual sound such as air escaping through the pipe as the water begins to flow. **DO NOT** smoke or use an open flame near the faucet at the time it is open.

## Safety Precautions

- A** Do not turn off power to water heater if it has been subjected to over heating, fire, flood, physical damage.
- B** **DO NOT** turn on water heater unless it is filled with water.
- C** **DO NOT** turn on water heater if cold water supply shut-off valve is closed.
- D** If there is any difficulty in understanding or following the Operating Instructions or the Care and Cleaning section, it is recommended that a qualified person or serviceman perform the work.

---

**▲ WARNING:** If the water heater has been subjected to fire, flood or physical damage, turn off power to water heater, and **DO NOT** operate the water heater again until it has been checked by a qualified service technician.

NOTICE: **DO NOT** use this appliance if any part has been under water. Immediately call a qualified installer or service agency to replace a flooded water heater. **DO NOT** attempt to repair the unit! It must be replaced.

## Safety Controls

The water heater is equipped with a temperature limiting control (ECO) that is located above the upper heating element in contact with the tank surface. If for any reason the water temperature becomes excessively high, the temperature limiting control (ECO) breaks the power circuit to the heating element. Once the control opens, it must be reset manually.

**▲ CAUTION:** The cause of the high temperature condition must be investigated by qualified service technician and corrective action must be taken before placing the water heater in service again.

To reset the temperature limiting control: (Refer to Illustration on page 21):

- 1** Turn off the power to the water heater.
- 2** Remove the upper cavity cover and insulation.
- 3** Press the red RESET button.
- 4** Replace the insulation, jacket access panel and plastic housing before turning on the power to the water heater.

**▲ DANGER:** There is a hot water scald potential if the thermostat is set too high. Households with small children, disabled, or elderly persons may require a 120°F or lower thermostat setting to prevent contact with HOT water.

## Water Temperature Setting

The temperature of the water in the water heater can be regulated by selecting the desired temperature on control display.

Safety and energy conservation are factors to be considered when selecting the water temperature setting of the water heater. The lower the temperature setting, the greater the savings in energy and operating costs.

To comply with safety regulations the temperature is factory set at 120°F or less where local codes require. This is the recommended starting point.

Water temperatures above 125°F can cause severe burns or death from scalding. Be sure to read and follow the warnings outlined in this manual and on the label on the water heater.

This label is located on the front of the water heater.

Mixing valves are recommended for reducing point of use water temperature by mixing hot and cold water in branch water lines. It is recommended that a mixing valve complying with the Standard for Temperature Actuated Mixing Valves for Hot Water Distribution Systems, ASSE 1017 be installed. See page 4 for more details and contact a licensed plumber or the local plumbing authority for further information.

The chart on the page 3 may be used as a guide in determining the proper water temperature for your home.

# Basic Water Heater Operation

---

## Navigating the Home Screen

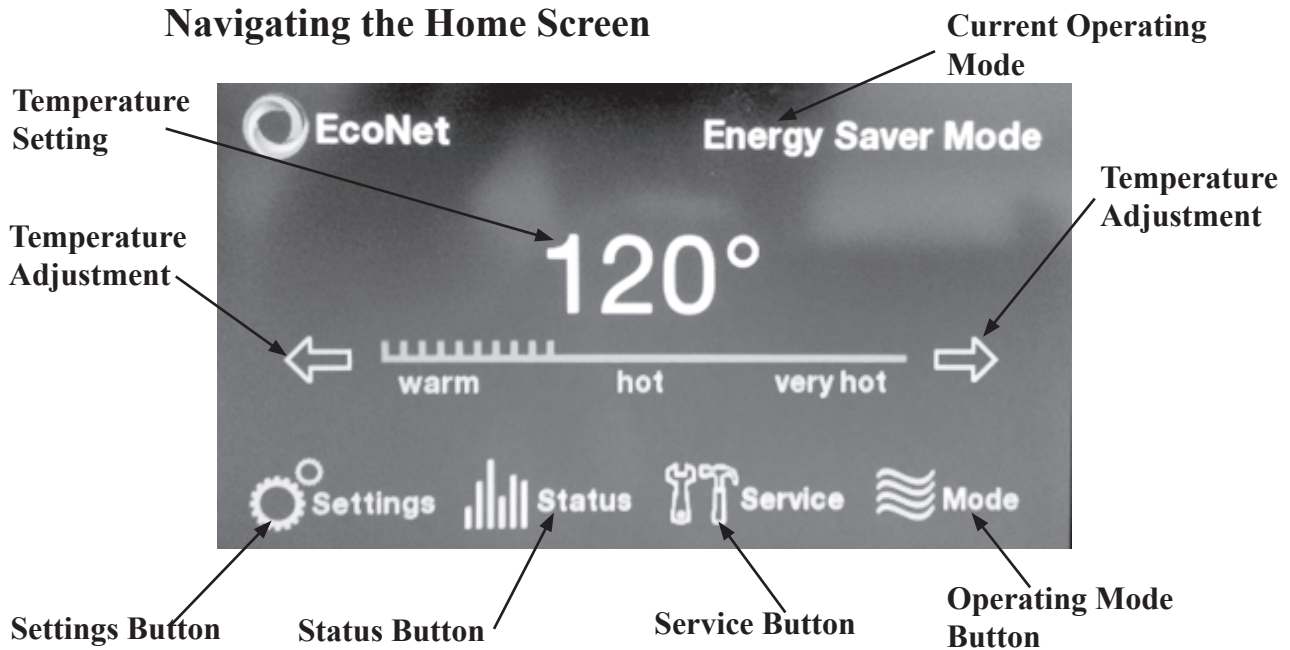

---

## Operational Control and Modes



Once power is applied to the water heater, the Operational Control Buttons can be used to activate the heating of water.

To turn the water heating "On", press the "Mode" button once.

Water heater ships in the default "Energy Saver" mode with a temperature setting of 120° F.

**Recommended temperature setting 120° F.**

To turn the water heating "OFF", press the "Mode" button repeatedly until the screen displays "Water Heater Off" Mode" ..

---

## Temperature Adjustment



**⚠ DANGER:** Hotter water increases the potential for **HOT** water **SCALDS**

Tank temperature will be maintained according to the setting on the Home Screen. If the water temperature setting needs adjustment, use the arrows on the control display to select desired temperature.

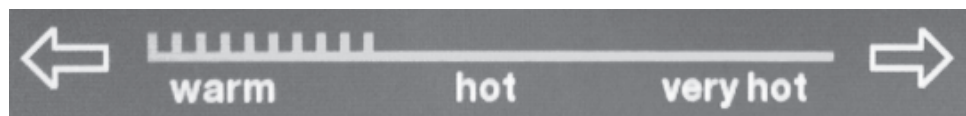

# Basic Water Heater Operation

---

## Operating Mode

Press the "Mode" button repeatedly to select one of the six modes of operation (the "Off" Mode has been discussed previously). The active mode is displayed on top of the screen.

### Heat Pump Only

This mode will heat with compressor operation only and will not use any electric heat during typical heating and demand cycles. This mode will minimize power consumption.

### Energy Saver - Factory set mode for shipping.

This mode optimizes compressor and electric heat that results in water heater performance that meets Energy Star requirements.

As a result, compressor operation will be maximized and use of electric heat will be minimized.

### High Demand

This mode will maximize the performance of the water heater while still providing good energy savings. Water heater operates with simultaneous compressor and electric heat.

### Electric Only

This Mode will heat with the electric resistance elements. This mode should only be used during filter and condensate drain maintenance periods. This mode will result in maximum power consumption.

### Vacation

This mode will allow duration setting between 1 and 28 days or set indefinitely with the "Hold" setting. Tank temperature will be maintained at about 65° F. Only compressor operation will be allowed as needed.

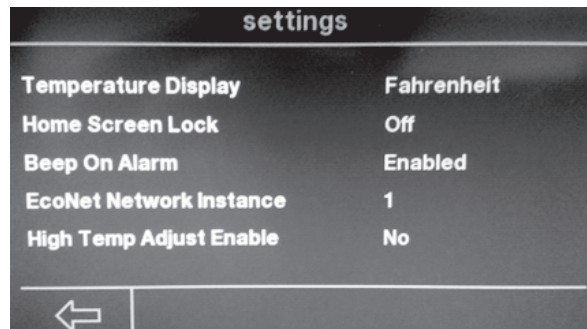

## Settings

The Settings Screen allows the following changes:

**Temperature Display Units:** The temperature display on the Home Screen can be set to Fahrenheit or Celsius

**Home Screen Lock:** The Home Screen can be locked to eliminate accidental changing of the Mode or Temperature

**Beep on Alarm:** The audible Alarm tone can be disabled during service periods.

**EcoNet Network Instance:** This number can be set between 1 and 16. Instance

is the way an EcoNet network identifies each appliance of the same model on the network. Up and down arrows appear in the bottom of the screen once EcoNet Network Instance button is pressed. Instance value can be set using these buttons.

**High Temperature Enable:** This setting can be set to "Yes" if a tank temperature higher than 140°F is desired. This setting will automatically turn "No" after 10 minutes of inactivity on the user interface.



# Basic Water Heater Operation

---

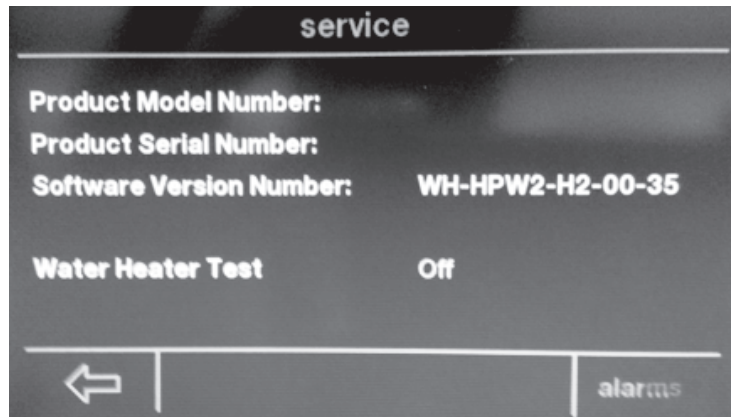
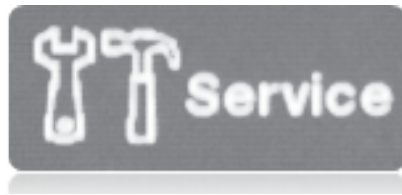

The Service screen provides information on the product description, testing software version, and alarms. Alarm details can be found in the "Troubleshooting Alarm Codes" section of the manual.

In case there is an active alarm, the "alarms" button will blink in the lower right corner. Pressing the "Alarms" button will show a new screen containing the active alarms and alarm history.

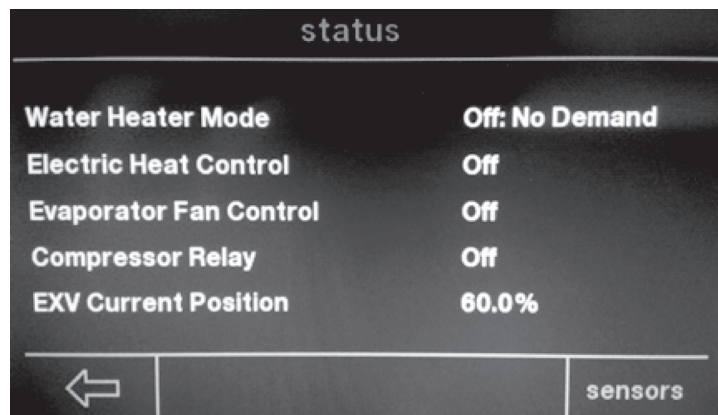

The Status screen provides information on the current operating status,

diagnostics, and related to sensors.

# Care and cleaning of the water heater

## Draining the Water Heater

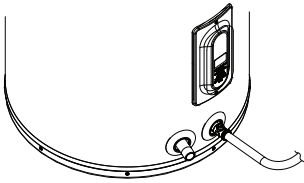

**▲CAUTION:** Shut off power to the water heater before draining water.

**▲DANGER:** Before manually operating the relief valve, make certain no one will be exposed to the hot water released by the valve. The water drained from the tank may be hot enough to present a scald hazard and should be directed to a suitable drain to prevent injury or damage.

In order to drain the water heater, turn off the cold water supply. Open a hot water faucet or lift the handle on the relief valve to admit air to the tank.

Attach a garden hose to the drain valve on the water heater and direct the stream of water to a drain. Open the valve.

## Routine Preventative Maintenance

Properly maintained, your water heater will provide years of dependable trouble-free service.

It is suggested that a routine preventive maintenance program be established and followed by the user.

It is further recommended that a periodic inspection of the electronic control, heat pump and wiring should be made by service personnel qualified in electric appliance repair.

Most electrical appliances, even when new, make some sound when in operation. If the hissing or singing sound level increases excessively, Contact a qualified installer or plumbing contractor to inspect.

**IMPORTANT:** See "DANGER on left". At least once a year, lift and release the lever handle on the temperature pressure relief valve, located on the side of the water heater, to make certain the valve operates freely. Allow several gallons to flush through the discharge line to an open drain.

It is recommended to clean the filter on top of the heat pump every month. Clean by washing with mild detergent and water. Dry and replace. Remove the filter by lifting up, then replace by lowering back

into the filter slot on top of the unit. See Figure below.

**Periodically check the condensate drain and condensate overflow to ensure they are open to permit draining of the condensate.**

A water heater's tank can act as a setting basin for solids suspended in the water. It is therefore not uncommon for hard water deposits to accumulate in the bottom of the tank. It is suggested that a few quarts of water be drained from the water heater's tank every month to clean the tank of these deposits.

Rapid closing of faucets or solenoid valves in automatic water using appliances can cause a banging noise heard in a water pipe. Strategically located risers in the water pipe system or water hammer arresting devices can be used to minimize the problem.

**▲DANGER:** Before manually operating the relief valve, make certain no one will be exposed to the danger of coming in contact with the hot water released by the valve. The water may be hot enough to create a scald hazard. The water should be released into a suitable drain to prevent injury or property damage.

**NOTICE:** If the temperature and pressure relief valve on the hot water heater discharges periodically, this may be due to thermal expansion in a closed water system. Contact the water supplier or your plumbing contractor on how to correct this. **DO NOT** plug the relief valve outlet.

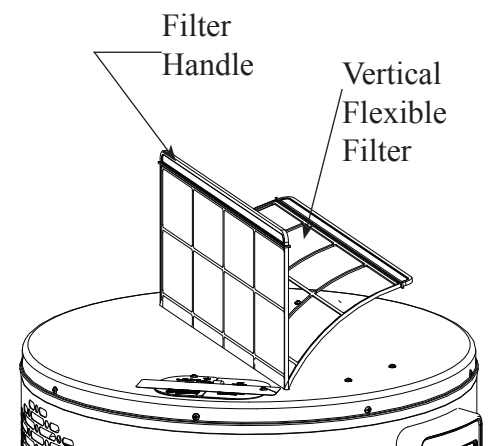

# Care and Cleaning of the Water Heater

---

## Vacation and Extended Shut-Down

**NOTICE: Refer to the Hydrogen Gas Caution in the Operating Instructions.**

If the water heater is to remain idle for an extended period of time, the power and water to the appliance should be turned off to conserve energy and prevent a build-up of dangerous hydrogen gas.

After a long shut-down period, the water heater's operation and controls should be checked by qualified service personnel. Make certain the water heater is completely filled again before placing it in operation.

The water heater and piping should be drained if they might be subjected to freezing temperatures.

---

## Anode Rod

**NOTICE: DO NOT remove the anode rod from the water heater's tank. Operation with the anode rod removed will greatly shorten the life of the glass lined tank and will exclude warranty coverage.**

This water heater is equipped with an anode rod designed to prolong the life of the glass-lined tank. The anode rod is slowly consumed, thereby eliminating or minimizing corrosion of the glass-lined tank.

Water sometimes contains a high sulfate and/or mineral content and together with cathodic protection process can produce a hydrogen sulfide, or rotten egg odor in the heated water. Chlorination of the water supply should minimize the problem.

## Before You Call For Service...



### Troubleshooting Tips

Save time and money! Review the chart on this page first and you may not need to call for service.

Problem	Possible Causes	What to Do
<b>Rumbling noise</b>	Water conditions in your home caused a build up of scale or mineral deposits in the water heater.	<ul style="list-style-type: none"> <li>● Allow a few quarts of water to run from drain valve to remove sediment settlements.</li> </ul>
<b>Relief valve producing popping noise or draining</b>	Pressure build up caused by thermal expansion in a closed system	<ul style="list-style-type: none"> <li>● This is an unacceptable condition and must be corrected. Contact the water supplier or plumbing contractor on how to correct this. <b>DO NOT</b> plug the relief valve outlet</li> </ul>
<b>Not enough or no hot water</b>	Water usage may have exceeded the capacity of the water heater.	<ul style="list-style-type: none"> <li>● Wait for the water heater to recover after an abnormal demand</li> </ul>
	A fuse is blown or a circuit breaker tripped	<ul style="list-style-type: none"> <li>● Replace fuse or reset circuit breaker</li> </ul>
	Electric supply may be off	<ul style="list-style-type: none"> <li>● Confirm electric supply to water heater and see installation section of this manual.</li> </ul>
	The thermostat may be set too low.	<ul style="list-style-type: none"> <li>● See the Temperature regulation of the water heater section of this manual</li> </ul>
	Leaking or open hot water faucets	<ul style="list-style-type: none"> <li>● Make sure all faucets are closed</li> </ul>
	Electric service to your home may be interrupted	<ul style="list-style-type: none"> <li>● Contact the local electric utility.</li> </ul>
	Improper wiring.	<ul style="list-style-type: none"> <li>● See the Installing the water heater section of this manual.</li> </ul>
	Manual reset limit (ECO)	<ul style="list-style-type: none"> <li>● See the Temperature regulation of the water heater Refer to page 3 for more information.</li> </ul>
	Cold water inlet temperature may be colder during the winter months	<ul style="list-style-type: none"> <li>● This is normal. The colder inlet water takes longer to heat.</li> </ul>
Not enough clearance air exchange.	<ul style="list-style-type: none"> <li>● Make sure there is at least 1000 cubic feet of air space surrounding the water heater or 250 cubic feet per minute of unconditioned air exchange..</li> </ul>	
<b>Water is too hot</b>	The thermostat is set too high.	<ul style="list-style-type: none"> <li>● See the Temperature regulation of the water heater section of this manual</li> </ul>
<p><b>⚠ CAUTION:</b> For your safety <b>DO NOT</b> attempt repair of electrical wiring, thermostats, heating elements or other safety devices. Refer repairs to qualified service personnel.</p>		

# Troubleshooting Alarm Codes



## Troubleshooting Tips

Save time and money! Review the chart on this page first and you may not need to call for service.

The water heater will make an audible beep for notification of Alarms. The following steps should be used in determining the Alarm code:

- 1) Press Blinking "Service" Button on the Home Screen

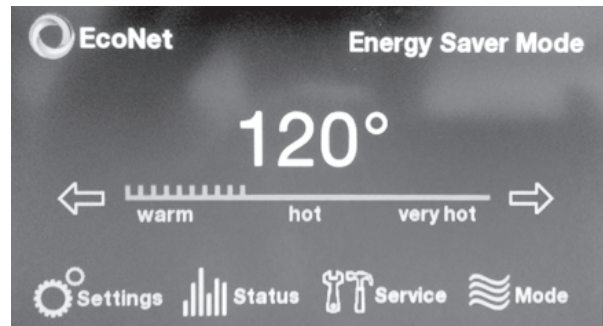
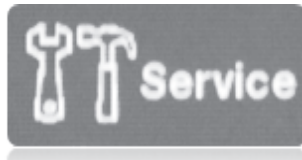

- 2) Press Blinking "Alarm" Button on the Service Screen

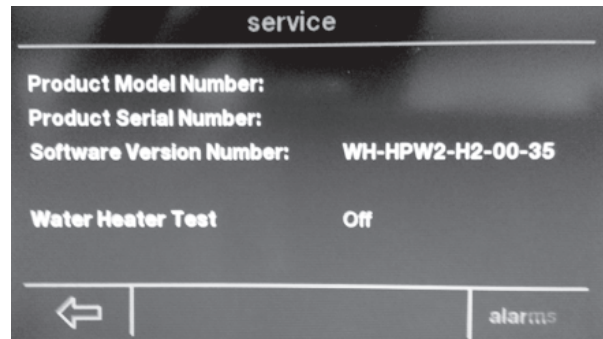

- 3) Alarm will be listed on Alarm Screen\*.

\* A103 Alarm shown as an example. During normal operation, there should not be any alarm listed under "Current Alarms".

The following page details Alarm code

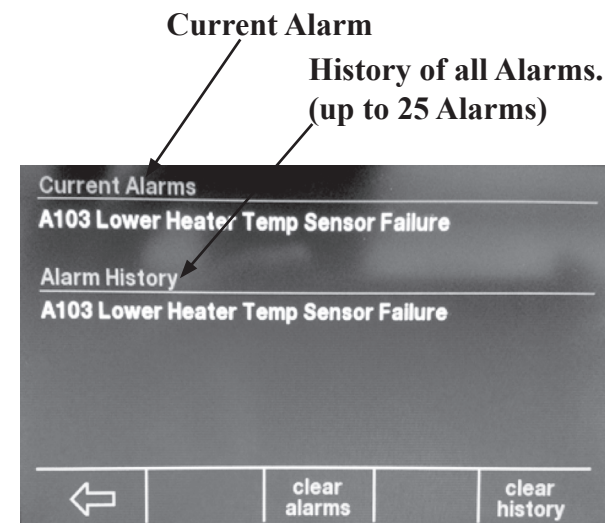

## Troubleshooting Alarm Codes

Code	Possible Causes	What To Do
A001	Configuration Data Restore Failure	Refer to "Replacement Parts" and/or "Service" sections of this manual
A004	Comp.Shutdown: Discharge-Suction Trip	
A005	Compressor Shutdown: Discharge Temp High	
A006	Suction Temp Low: Check Evap Fan or Filter	
A007	Compressor Shutdown: Hi Press. Switch Trip	
A008	Detected Dry Fire Condition / Water Heater is not full of water	Refer "To Fill the Water Heater" section of this manual
A101	Suction Temperature Sensor Failure	Refer to "Replacement Parts" and/or "Service" sections of this manual
A102	Ambient Temperature Sensor Failure	
A103	Lower Heater Temp Sensor Failure	
A104	Upper Heater Temp Sensor Failure	
A105	Evaporator Temp Sensor Failure	
A106	Discharge Temp Sensor Failure	
A110	Lower Temp. Conversion Stuck Error	
A111	Upper Temp. Conversion Stuck Error	
A112	Upper/Lower Temp.Conversions Stuck Error	
A113	A2D Reference Conversion Drift Error	
A125	Lower Element Error	
A126	Upper Element Error	
A127	Element Wire Routing Error	Refer to "Electrical Connections" section of this manual
A128	Lower Element Relay Stuck On Error	
A129	Upper Element Relay Stuck On Error	
A200	Emergency Cut Off (ECO) Alarm	Refer to "Safety Control" section of this manual



# Replacement Parts.

## Instructions For Placing a Parts Order

Address parts orders to the distributor or store where the heater was purchased.

All parts orders should include:

- 1 The model and serial number of the water heater from the rating plate located on the tank jacket.
- 2 Specify voltage and wattage as marked on the rating plate.

- 3 Part description (as noted below) and number of parts desired.

**⚠CAUTION: For your safety DO NOT attempt repair of electrical wiring, heating elements, heat pump or electronic controls. Refer repairs to qualified service personnel.**

Replacement Parts Not Shown
Fan Motor
Thermister
Capacitor
Anode
Wiring Harness
Compressor Wiring Harness
EXV Solenoid w/harness
Upper thermostat protective cover
Cavity Cover Insulation

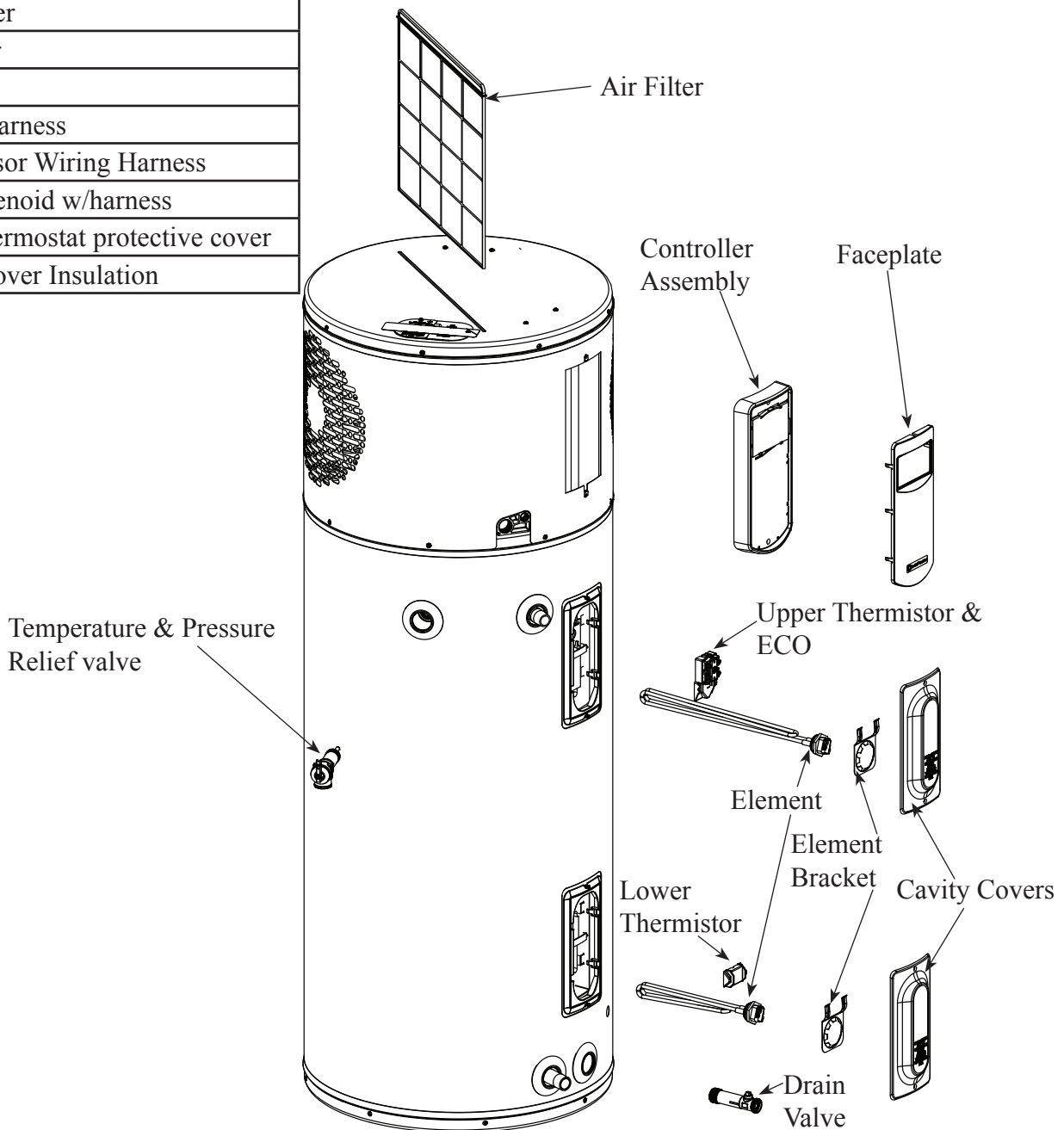

## Cavity Insert Instructions

---

The following instructions are intended for qualified service personnel **ONLY**, and should only be done when necessary.

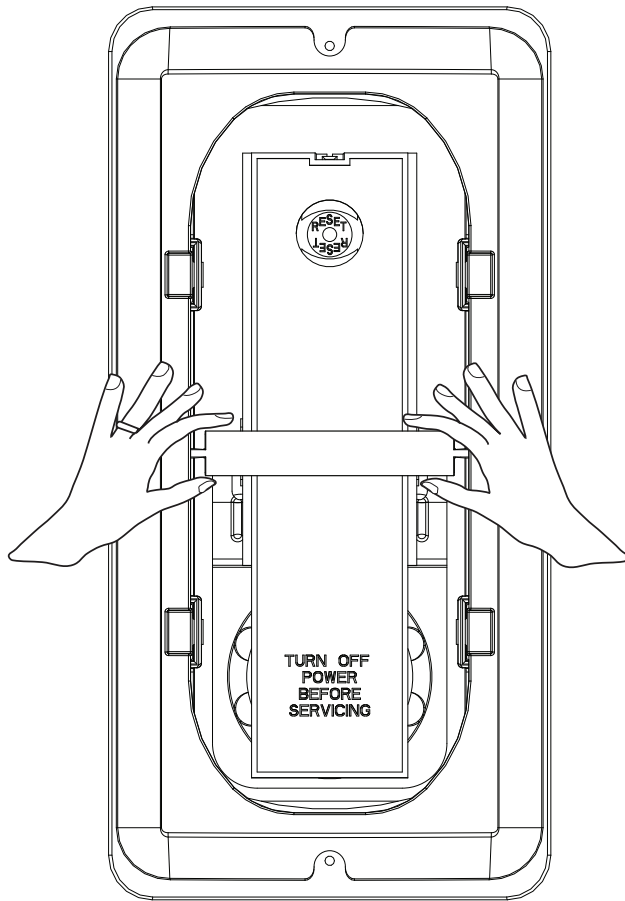

In order to replace the ECO,thermistor or heating element, remove the cavity insert crossbar by following the instructions below:

- 1 Turn off the power to the water heater.
- 2 Remove the jacket access panel(s) and insulation.
- 3 Rotate the crossbar up and down until it breaks away from the remainder of the cavity insert. (See illustration to the left)
- 4 Discard the crossbar. It cannot and need not be replaced.  
Replace the ECO,thermistor and/or element as necessary.
- 5 Replace the insulation, jacket access panel(s) and plastic housing before turning on the power to the water heater.

**NOTICE: The cavity insert crossbar is necessary for the manufacturing process only. The removal of the crossbar will not interfere with the operation of the water heater.**

# Wiring Diagram

## WIRING DIAGRAM

\* ON SOME MODELS ONLY

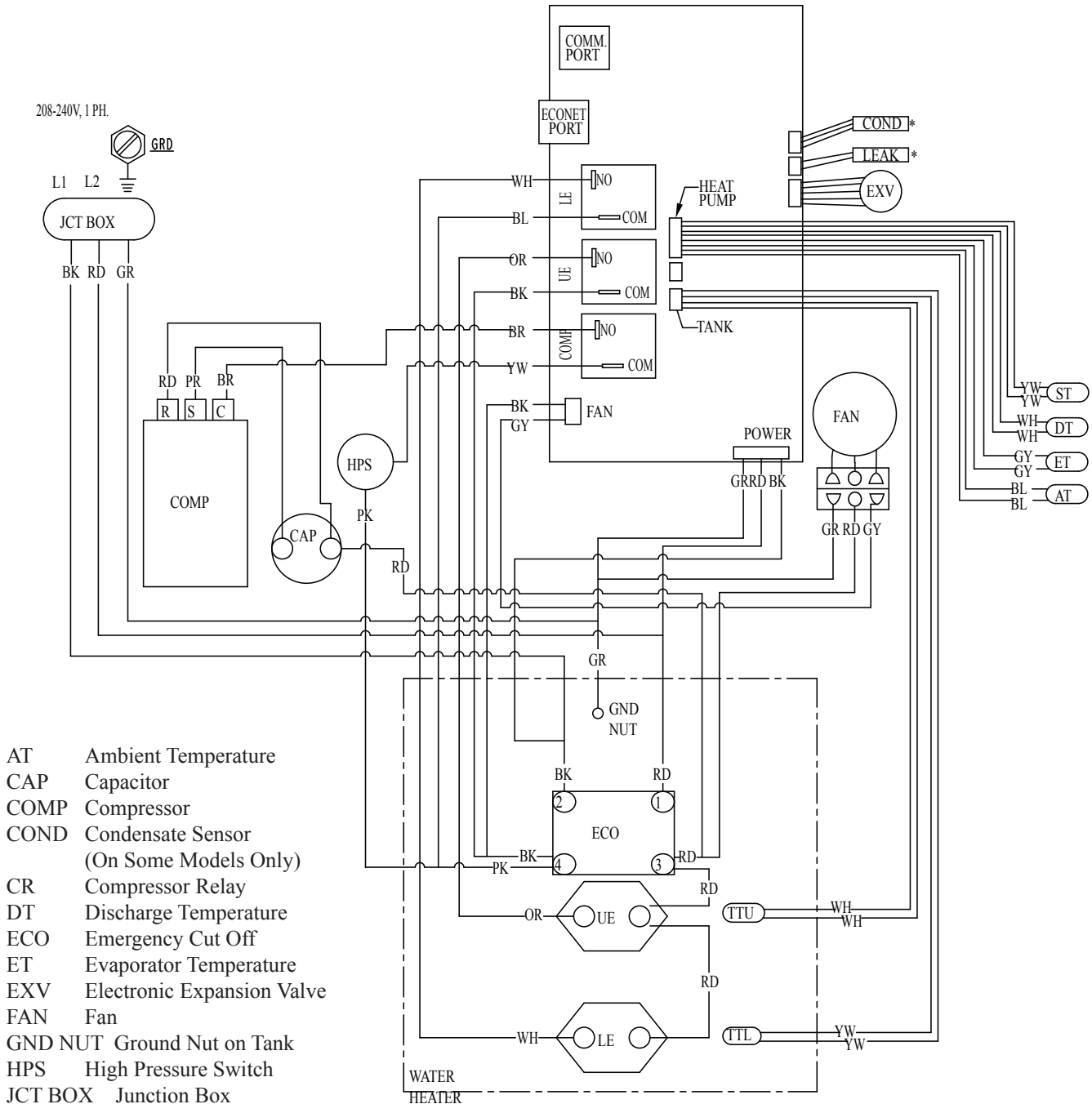

- AT Ambient Temperature
- CAP Capacitor
- COMP Compressor
- COND Condensate Sensor  
(On Some Models Only)
- CR Compressor Relay
- DT Discharge Temperature
- ECO Emergency Cut Off
- ET Evaporator Temperature
- EXV Electronic Expansion Valve
- FAN Fan
- GND NUT Ground Nut on Tank
- HPS High Pressure Switch
- JCT BOX Junction Box
- LE Lower Element
- LER Lower Element Relay
- LEAK Leak Sensor  
(On Some Models Only)
- ST Suction Temperature
- TTL Tank Temperature – Lower
- TTU Tank Temperature – Upper
- UE Upper Element
- UER Upper Element Relay

# IF YOU NEED SERVICE

---



1. Should you have any questions about your new water heater, or if it requires adjustment, repair, or routine maintenance, it is suggested that you first contact your installer, plumbing contractor or previously agreed upon service agency. In the event the firm has moved, or is unavailable, refer to the telephone directory, commercial listings or local utility for qualified service assistance.
2. Should your problem not be solved to your complete satisfaction, you should then contact the Manufacturer's National Service Department at the following address:  
1241 Carwood Court  
Montgomery, Alabama 36117  
Phone: 1-800-995-0982.

When contacting the manufacturer, the following information will be requested:

- a. Model and serial number of the water heater as shown on the rating label located on front of the water heater.
- b. Address where the water heater is located and physical location.
- c. Name and address of installer and any service agency who performed service on the water heater.
- d. Date of original installation and dates any service work was performed.
- e. Details of the problems as you can best describe them.
- f. List of people, with dates, who have been contacted regarding your problem.