

⚠ WARNING:

RECOGNIZE THIS SYMBOL AS AN INDICATION OF IMPORTANT SAFETY INFORMATION

⚠ WARNING

THESE INSTRUCTIONS ARE INTENDED AS AN AID TO QUALIFIED, LICENSED SERVICE PERSONNEL FOR PROPER INSTALLATION, ADJUSTMENT, AND OPERATION OF THIS UNIT. READ THESE INSTRUCTIONS THOROUGHLY BEFORE ATTEMPTING INSTALLATION OR OPERATION. FAILURE TO FOLLOW THESE INSTRUCTIONS MAY RESULT IN IMPROPER INSTALLATION, ADJUSTMENT, SERVICE, OR MAINTENANCE POSSIBLY RESULTING IN FIRE, ELECTRICAL SHOCK, PROPERTY DAMAGE, PERSONAL INJURY, OR DEATH.

Do not destroy this manual. Please read carefully and keep in a safe place for future reference by a serviceman.

[] indicates metric conversions.

92-105074-14-03 (/) Printed in USA

VARIABLE SPEED R-410A HEAT PUMP OUTDOOR UNITS



INSTALLATION INSTRUCTIONS

**(-)P20 (20 SEER) EQUIPPED WITH
ECONET™ COMMUNICATIONS**

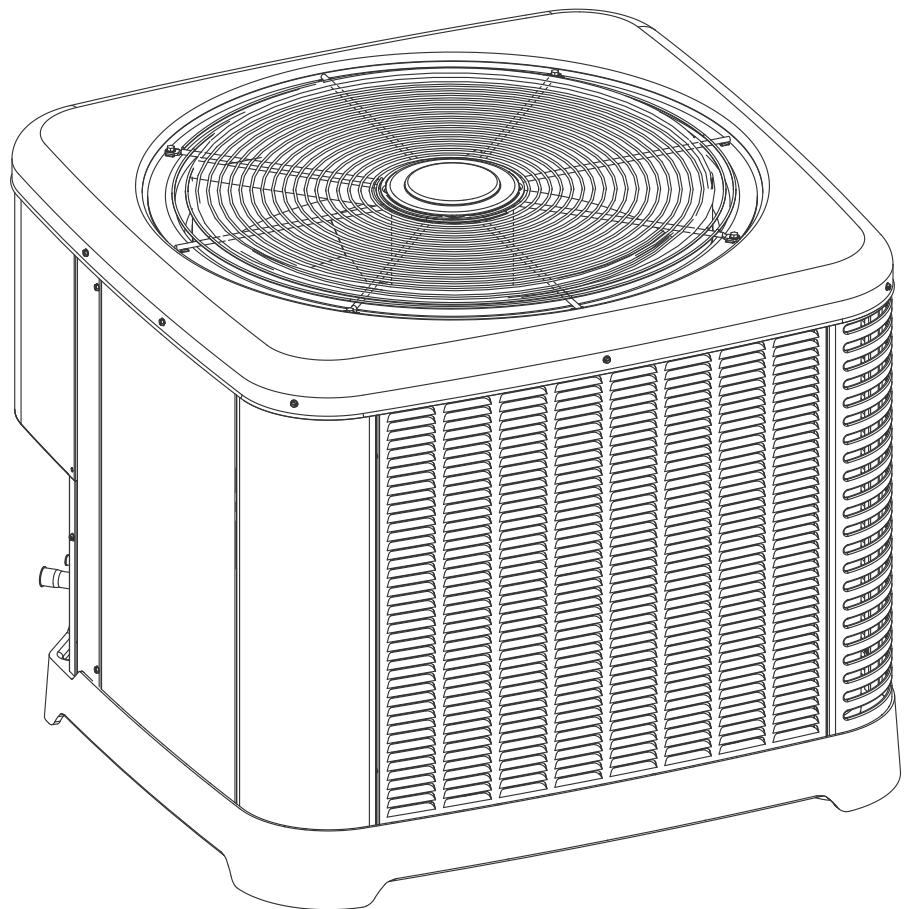

ISO 9001:2008
Certificate Number: 3064



CONTENTS

1.0 IMPORTANT SAFETY INFORMATION.....	3
2.0 GENERAL INFORMATION.....	4-5
2.1 Introduction.....	4
2.2 Agency Performance Audit Testing Notice.....	4
2.3 Importance of a Quality Installation.....	4
2.4 System Sizing and Selection.....	4
2.5 Importance of Proper Indoor/Outdoor Match-Ups.....	5
2.6 Checking Product Received.....	5
2.7 Compressor Break-In Notice.....	5
3.0 UNIT SPECIFICATIONS.....	5-6
3.1 Model Number Nomenclature and Available Models.....	5
3.2 Electrical and Physical Data.....	6
4.0 INSTALLATION.....	7-25
4.1 Tools & Refrigerant.....	7
4.1.1 Tools Required for Installing & Servicing R-410A Models.....	7
4.1.2 Specifications of R-410A.....	7
4.1.3 Quick Reference Guide for R-410A.....	7
4.2 Choosing a Location.....	8
4.2.1 Allowable Clearances.....	8
4.2.2 Operational Issues Related to Unit Location.....	8
4.2.3 Corrosive Environments.....	9
4.2.4 Customer Satisfaction Issues.....	9
4.3 Mounting Unit.....	9
4.3.1 Unit-Mounting Methods.....	9
4.3.2 High Wind and Seismic Tie-Down Methods.....	9
4.3.3 Elevating Unit.....	10
4.3.4 Ground Snow Depth Table.....	10
4.4 Refrigerant Line Set Selection.....	11
4.4.1 Replacing Existing Systems.....	11
4.4.2 Line Set Application Considerations.....	11
4.4.2.1 Oil Return to Compressor.....	11
4.4.2.2 Refrigerant Migration During Off Cycle.....	11
4.4.2.3 Maximum Liquid Pressure Drop.....	11
4.4.2.4 Liquid Line Refrigerant Flashing.....	11
4.4.2.5 Compressor Oil Level Adjustment.....	12
4.4.2.6 Capacity Losses.....	12
4.4.3 Line Set Length and Fitting Losses.....	12
4.4.4 Liquid Line Selection.....	13
4.4.5 Vapor Line Selection.....	13
4.5 Line Set Installation.....	16
4.5.1 Important Tubing Installation Practices.....	16
4.5.2 Relative Location of Indoor and Outdoor Units.....	17
4.5.2.1 Indoor and Outdoor Unit Near Same Level.....	17
4.5.2.2 Outdoor Unit Below Indoor Unit.....	18
4.5.2.3 Outdoor Unit Above Indoor Unit.....	19
4.5.3 Tubing Connections.....	20
4.6 Initial Leak Testing.....	21
4.7 Evacuation.....	21
4.8 Final Leak Testing.....	22
4.9 Control Wiring.....	22
4.9.1 EcoNet™ Communications.....	22
4.9.2 EcoNet™ Control Center Installation.....	22
4.9.3 EcoNet™ Communication Wiring Connections.....	22
4.9.4 Conventional 24VAC Thermostat Control Wiring Connections.....	23
4.10 Power Wiring.....	24
4.11 Grounding.....	25
5.0 SYSTEM START-UP AND REFRIGERANT CHARGING.....	25-29
5.1 System Start-Up Overview.....	25
5.2 Initial Power Up and EcoNet™ Communication Verification.....	25
5.3 EcoNet™ Control Center Set-Up.....	25
5.4 Initial System Set-Up.....	26
5.5 Setting up Charging Mode Using EcoNet™ Control Center Service Menu.....	26
5.6 Setting up Charging Mode Using Variable Speed Outdoor Control Menu.....	26
5.7 Indoor Air-Flow Verification.....	27
5.8 Refrigerant Charging.....	27
5.8.1 Measurement Device Set-Up.....	28
5.8.2 Preliminary Charging by Weight.....	28
5.8.3 Preliminary Charging by Pressures.....	28
5.8.4 Final Charging by Liquid Subcooling.....	29
5.8.5 R-410A Temperature Pressure Chart.....	29
5.9 Completing Installation.....	29
6.0 NORMAL SEQUENCE OF OPERATION.....	30-32
6.1 Cooling Mode.....	30
6.2 On-Demand Cooling Dehumidification.....	30
6.3 Low Ambient Cooling Operation.....	30
6.4 Heating Mode.....	30
6.5 Supplemental Electric Heat During Heating Mode.....	31
6.6 Dual Fuel Applications - Heating Mode.....	31
6.7 Demand Defrost.....	31
6.8 Sequence of Operation for Conventional 24VAC Thermostat Controls.....	32
7.0 COMPONENTS AND CONTROLS.....	33-39
7.1 Accumulator.....	33
7.2 Choke/Inductor.....	33
7.3 Coil Temperature Thermistor.....	33
7.4 Compressor.....	33
7.5 Discharge Line Thermistor.....	33
7.6 EcoNet™ Variable Speed Outdoor Control (VSODC).....	34
7.6.1 Board Features and Connections.....	34
7.6.2 TEST & SW2 Buttons.....	35
7.6.3 Memory Card.....	35
7.6.4 Factory Superheat Setting.....	35
7.6.5 Superheat Offset DIP Switch Settings.....	35
7.6.6 Defrost Termination Temperature DIP Switched.....	35
7.6.7 Menu Structure.....	36
7.6.8 Replacement of the VSODC.....	36
7.7 Electronic Expansion Valve.....	37
7.8 Filter & Ferrite Rings.....	37
7.9 High Pressure Control.....	38
7.10 Liquid Pressure Transducer.....	38
7.11 Liquid Temperature Thermistor.....	38
7.12 Outdoor Ambient Temperature Thermistor.....	38
7.13 Outdoor Fan Motor.....	38
7.14 Outdoor Fan Blade.....	38
7.15 Power Inverter Compressor Control.....	38
7.16 Suction Pressure Transducer.....	39
7.17 Suction Temperature Thermistor.....	39
8.0 ACTIVE SYSTEM PROTECTION FEATURES.....	40-42
8.1 Minimum Run Timer.....	40
8.2 Oil Return Cycle.....	40
8.3 Off-Cycle Refrigerant Migration – Stator Heat.....	40
8.4 High Discharge Temperature.....	40
8.5 High Discharge Pressure.....	40
8.6 Low Suction Pressure/Loss of Charge.....	40
8.7 Compressor Shut-Down Sequence for High or Low Refrigerant Pressure Fault.....	41
8.8 Over current and Current Imbalance.....	41
8.9 Compressor Operation Outside Envelope.....	41
8.10 Over and Under Voltage.....	41
8.11 Inverter Over Temperature.....	41
8.12 Controls and Communication Malfunction.....	41
8.13 Sensor Failure Default Operation.....	42
8.14 Exiting Active Protection Lock-Out Mode.....	42
9.0 DIAGNOSTICS AND TROUBLESHOOTING.....	43-72
9.1 Fault Recall Procedure.....	43
9.2 Compressor/Fan Motor Test Mode.....	43
9.3 Defrost Test Mode.....	43
9.4 Status and Diagnostic Codes.....	44
9.5 Active Protection Fault Details.....	52
9.6 Electrical Checks Flowchart.....	59
9.7 Cooling Mechanical Checks Flowchart.....	60
9.8 Heating Mechanical Checks Flowchart.....	61
9.9 Defrost Mechanical Checks Flowchart.....	62
9.10 Checking Transducers and Temperature Sensors.....	63
9.11 General Troubleshooting Guide.....	65
9.12 Service Analyzer Charts.....	66
9.13 Troubleshooting Tips.....	72
10.0 OUTDOOR UNIT MAINTENANCE.....	73
10.1 Outdoor Coil Cleaning.....	73
10.2 Cabinet Cleaning and Care.....	73
10.3 Motor Lubrication.....	73
10.4 Replacement Parts.....	73
11.0 WIRING DIAGRAM.....	74
12.0 APPENDIX.....	75-76
12.1 Agency Performance Audit Test Instructions.....	75

1.0 IMPORTANT SAFETY INFORMATION

⚠️ WARNINGS:

- These instructions are intended as an aid to qualified, licensed service personnel for proper installation, adjustment, and operation of this unit. Read these instructions thoroughly before attempting installation or operation. **Failure to follow these instructions may result in improper installation, adjustment, service, or maintenance possibly resulting in fire, electrical shock, property damage, personal injury, or death.**
- **The unit must be permanently grounded. Failure to do so can cause electrical shock resulting in severe personal injury or death.**
- **Turn off electric power at the fuse box or service panel before making any electrical connections.**
- **Complete the ground connection before making line voltage connections. Failure to do so can result in electrical shock, severe personal injury, or death.**
- **Disconnect all power to unit before starting maintenance. Failure to do so can cause electrical shock resulting in severe personal injury or death.**
- **Never assume the unit is properly wired and/or grounded. Always test the unit cabinet with a noncontact voltage detector available at most electrical supply houses or home centers before removing access panels or coming into contact with the unit cabinet.**
- **DO NOT use oxygen to purge lines or pressurize system for leak test. Oxygen reacts violently with oil, which can cause an explosion resulting in severe personal injury or death.**
- The top of the scroll compressor shell is hot. Touching the compressor top may result in serious personal injury.
- The manufacturer's warranty does not cover any damage or defect to the unit caused by the attachment or use of any components, accessories, or devices (other than those authorized by the manufacturer) into, onto, or in conjunction with the heat pump. **You should be aware that the use of unauthorized components, accessories, or devices may adversely affect the operation of the heat pump and may also endanger life and property.** The manufacturer disclaims any responsibility for such loss or injury resulting from the use of such unauthorized components, accessories, or devices.
- This product is not approved for installation at 2000 meters [6561 feet] above sea level or higher. Installation at higher altitudes may result in control and unit failures due to electrical arc tracking between electrical components on the inverter drive control board. Possibly resulting in fire, electrical shock, property damage, personal injury, or death.

⚠️ CAUTIONS:

- R-410A systems operate at approximately 60% higher pressures (1.6 times) than R-22 systems. Do not use R-22 service equipment or components on R-410A equipment. Use appropriate care when using this refrigerant. Failure to exercise care may result in equipment damage or personal injury.
- Only match this outdoor unit with a matched indoor coil or air handler approved for use with this outdoor unit per the unit manufacturer's specification sheet. The use of unmatched coils or air handler will likely result in a charge imbalance between the cooling and heating modes which can cause unsatisfactory operation including a high-pressure switch lockout condition.
- Only use indoor coils approved for use on R-410A systems. An R-22 coil will have a TXV or fixed expansion device that is not designed to operate properly in an R-410A system and will result in serious operational issues. The R-22 coil could also contain a significant amount of mineral oil which is incompatible with the POE oil used in R-410A systems and could result in reliability issues with the compressor and expansion devices.
- When the indoor coil or air handler is installed over a finished ceiling and/or living area, it is required that an auxiliary overflow pan be constructed and installed under the entire indoor unit. Failure to do so can result in property damage.
- **UNIT MAY START SUDDENLY AND WITHOUT WARNING.** The 7 segment LED on the Outdoor Control will flash c, C, h, or H when a call for unit operation is present, but the unit is in temporary lockout. The heat pump/defrost control will attempt to start unit after the anti-short cycle time expires, when a high or low pressure control automatically resets, or when the heat pump/defrost control exits the lockout mode as the temperature rises above -10°F.

2.0 GENERAL INFORMATION

⚠WARNING:

Improper installation, or installation not made in accordance with these instructions, can result in unsatisfactory operation and/or dangerous conditions and can cause the related warranty not to apply.

2.1 Introduction

The (-)P20 series heat pumps are specifically designed to operate with matching communicating EcoNet™ enabled air-handlers, gas furnaces, and Control Center. A conventional 24VAC 2-stage thermostat can be used, but many features and benefits are lost, so this is only recommended for emergency situations when there are issues with the EcoNet™ communications and the system must be made operational until the communication issues are resolved.

This installation instruction manual contains complete instructions for installation and setup using the EcoNet™ or conventional 24VAC controls. Please refer to the manufacturer's specification sheets for complete performance data, thermostat, and accessory listings.

The information contained in this manual has been prepared to assist in the proper installation, operation, and maintenance of the air conditioning system.

Read this manual and any instructions packaged with separate equipment required to make up the system prior to installation. Homeowner should retain this manual for future reference.

2.2 Agency Performance Audit Testing Notice

For purposes of verifying or testing efficiency ratings, the test procedure in Title 10 APPENDIX M to Subpart B of Part 430 (Uniform Test Method for Measuring the Energy Consumption of Central Air Conditioners and Heat Pumps) and the clarifying provisions provided in the AHRI Operations Manual 210/240 that were applicable at the date of manufacture should be used for test set up and performance.

Should this unit be selected for performance audit testing, follow the instructions included in the Appendix (Section 12.1) of this manual.

2.3 Importance of Quality Installation

A quality installation is critical to assure safety, reliability, comfort, and customer satisfaction. Strict adherence to applicable codes, the information in this installation manual, the outdoor unit installation manual, and the thermostat installation manual are key to a quality installation. Read the entire instruction manuals before starting the installation.

IMPORTANT: This product has been designed and manufactured to meet certified AHRI capacity and efficiency ratings with the appropriate outdoor units. However, proper refrigerant charge, proper airflow, and refrigerant line sizing are critical to achieve optimum capacity and efficiency and to assure reliable operation. Installation of this product should follow the manufacturer's refrigerant charging and airflow instructions located in this installation manual and the charging chart label affixed to the outdoor unit. Failure to confirm proper charge and airflow may reduce energy efficiency and shorten equipment life.

The equipment has been evaluated in accordance with the Code of Federal Regulations, Chapter XX, Part 3280.

Install the unit in accordance with applicable national, state, and local codes. Latest editions are available from: "National Fire Protection Association, Inc., Batterymarch Park, Quincy, MA 02269." These publications are:

- ANSI/NFPA No. 70-(Latest Edition) National Electrical Code.
- NFPA90A Installation of Air Conditioning and Ventilating Systems.
- NFPA90B Installation of warm air heating and air conditioning systems.

Install the unit in such a way as to allow necessary access to the coil/filter rack and blower/control compartment.

2.4 System Sizing and Selection

Before specifying any heat pump equipment, a survey of the structure and heat loss and heat gain calculations must be made. A heat loss calculation involves identifying all surfaces and openings that lose heat to the surrounding air in the heating mode and quantifying that heat loss. A heat gain calculation makes similar measurements and determines the amount of heat required to

2.0 GENERAL INFORMATION

be removed in the cooling mode. A heat gain calculation also calculates the extra heat load caused by sunlight and by humidity removal. These factors must be considered before selecting a heat pump system to provide year-round comfort. The Air Conditioning Contractors of America (ACCA) Manual J method of load calculation is one recognized procedure for determining the heating and cooling load.

After the proper equipment combination has been selected, satisfying both sensible and latent requirements, the system must be properly installed. Only then can the system provide the comfort it was designed to provide.

There are several factors that installers must consider.

- Outdoor unit location
- Indoor unit blower speed and airflow
- Proper equipment evacuation
- Supply and return air duct design and sizing
- Refrigerant charge
- System air balancing
- Diffuser and return air grille location and sizing

IMPORTANT: Excessive use of elbows in the refrigerant line set can produce excessive pressure drop. Follow industry best practices for installation. Installation and commissioning of this equipment is to be performed by trained and qualified HVAC professionals. For technical assistance, contact your Distributor Service Coordinator.

2.5 Importance of Proper Indoor/Outdoor

Match-Ups

To assure many years of reliable operation and optimum customer comfort and to assure the outdoor unit warranty remains valid, an air-handler model or indoor coil/furnace combination should be selected that is properly matched to the outdoor unit. This is especially critical for heat pump systems to assure proper refrigerant charge balance between the cooling and heating modes. The recommended approach is to select an air-handler or indoor coil and gas furnace that has an AHRI match with the outdoor unit. Refer to the AHRI directory at www.ahridirectory.org to confirm the air-handler and outdoor unit are a certified combination in the AHRI Directory.

2.6 Checking Product Received

Upon receiving unit, inspect it for any shipping damage. Claims for damage, either apparent or concealed, should be filed immediately with the shipping company. Check model number, electrical characteristics, and accessories to determine if they are correct. Check system components (indoor coil, outdoor unit, air handler/furnace, etc.) to make sure they are properly matched.

2.7 Compressor Break-In Notice

Prior to agency testing, system must be operated for 20 hours at 115°F [46.1°C] outdoor ambient temperature with 80°F [26.7°C] dry bulb 75°F [23.9°C] wet bulb indoor ambient temperature to break the compressor in.

3.0 UNIT SPECIFICATIONS

3.1 Model Number Nomenclature and Available Models

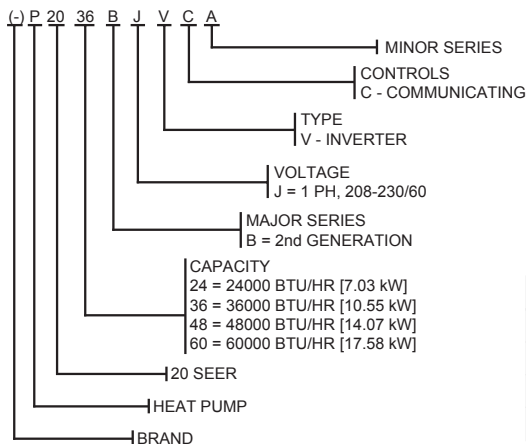

AVAILABLE MODELS
(-)P2024BJVCA
(-)P2036BJVCA
(-)P2048BJVCA
(-)P2060BJVCA

3.0 UNIT SPECIFICATIONS



3.2 Electrical and Physical Data

ELECTRICAL							
Model Number (-)P20	Phase Frequency (Hz) Voltage (Volts)	Compressor		Fan Motor Full Load Amperes (FLA)	Minimum Circuit Ampacity Amperes	Fuse or HACR Circuit Breaker	
		Rated Load Amperes (RLA)	Locked Rotor Amperes (LRA)			Minimum Amperes	Maximum Amperes
24B	1-60-208/230	15.4	35	1.9	21	25	30
36B	1-60-208/230	24.0	50	1.8	32	40	50
48B	1-60-208/230	28.1	50	1.2	34	50	60
60B	1-60-208/230	31.7	50	2.0	42	50	60

PHYSICAL					
Model Number (-)P20	Outdoor Coil			Weight	
	Face Area Sq. Ft. [m ²]	No. Rows	Refrig. Per Circuit Oz. [g]	Net Lbs. [kg]	Shipping Lbs. [kg]
24B	28.40 [2.6]	1	210 [5953]	278 [125]	282 [125]
36B	32.44 [3.0]	1	212 [6010]	298 [135]	306 [139]
48B	32.44 [3.0]	1	222 [6282]	298 [135]	306 [139]
60B	32.44 [3.0]	1	252 [7144]	301 [137]	309 [140]

DIMENSIONS

(-)P20	24B	36B	48B	60B
Height "H" inches (mm)	45 (1143)	51 (1295)	51 (1295)	51 (1295)
Length "L" inches (mm)	35.75 (908)	35.75 (908)	35.75 (908)	35.75 (908)
Width "W" inches (mm)	35.75 (908)	35.75 (908)	35.75 (908)	35.75 (908)

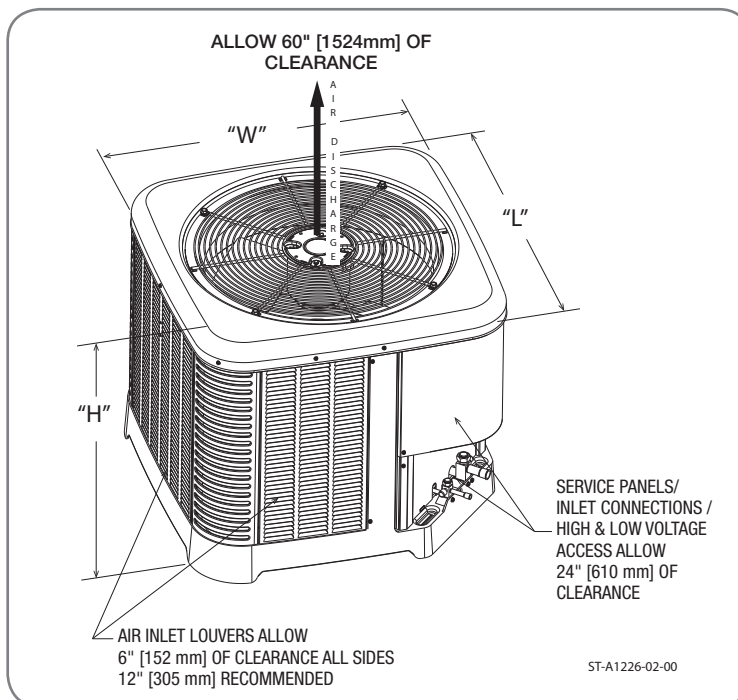

4.0 INSTALLATION



4.1 Tools and Refrigerant

4.1.1 Tools Required for Installing and Servicing R-410A Models

Manifold Sets:

- Up to 800 PSIG [5,516 kPa] High-Side
- Up to 250 PSIG [1,724 kPa] Low-Side
- 550 PSIG [3,792 kPa] Low-Side Retard

Manifold Hoses:

- Service Pressure Rating of 800 PSIG [5,516 kPa]

Recovery Cylinders:

- 400 PSIG [2,758 kPa] Pressure Rating
- Dept. of Transportation 4BA400 or BW400

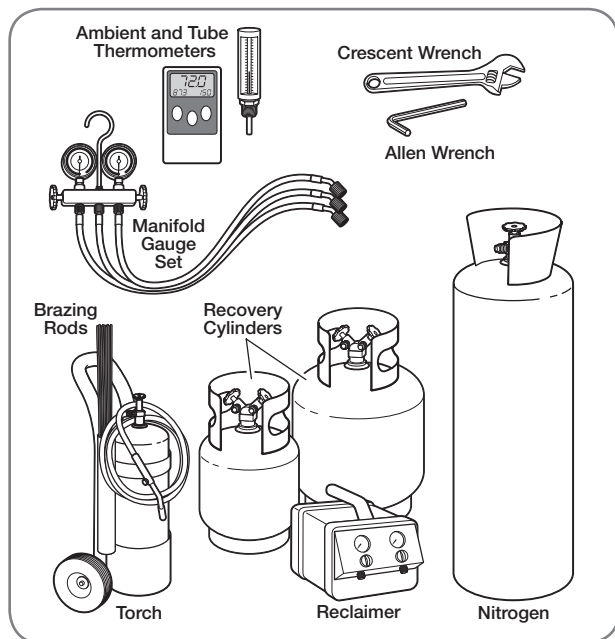

⚠ CAUTION: R-410A systems operate at higher pressures than R-22 systems. Do not use R-22 service equipment or components on R-410A equipment.

4.1.2 Specifications of R-410A

Application: R-410A is not a drop-in replacement for R-22. Equipment designs must accommodate its higher pressures. It cannot be retrofitted into R-22 heat pumps.

Physical Properties: R-410A has an atmospheric boiling point of -62.9°F [-52.7°C] and its saturation pressure at 77°F [25°C] is 224.5 psig [1,548 kPa].

Composition: R-410A is a near-azeotropic mixture of 50% by weight difluoromethane (HFC-32) and 50% by weight pentafluoroethane (HFC-125).

Pressure: The pressure of R-410A is approximately 60% (1.6 times) greater than R-22. Recovery and recycle equipment, pumps, hoses, and the like must have design pressure ratings appropriate for R-410A. *Manifold sets need to range up to 800 psig [5,516 kPa] high-side and 250 psig [1,724 kPa] low-side with a 550 psig [3,792 kPa] low-side retard. Hoses need to have a service pressure rating of 800 psig [5,516 kPa]. Recovery cylinders need to have a 400 psig [2,758 kPa] service pressure rating, DOT 4BA400 or DOT BW400.*

Combustibility: At pressures above 1 atmosphere, a mixture of R-410A and air can become combustible. **R-410A and air should never be mixed in tanks or supply lines or be allowed to accumulate in storage tanks. Leak checking should never be done with a mixture of R-410A and air.** Leak-checking can be performed safely with nitrogen or a mixture of R-410A and nitrogen.

4.1.3 Quick-Reference Guide for R-410A

- R-410A refrigerant operates at approximately 60% higher pressure (1.6 times) than R-22. Ensure that servicing equipment is designed to operate with R-410A.
- R-410A refrigerant cylinders are light rose in color.
- R-410A, as with other HFCs, is only compatible with POE oils.
- Vacuum pumps will not remove moisture from POE oil used in R-410A systems.
- R-410A systems are to be charged with liquid refrigerants. Prior to March 1999, R-410A refrigerant cylinders had a dip tube. These cylinders should be kept upright for equipment charging. Post-March 1999 cylinders do not have a dip tube and should be inverted to ensure liquid charging of the equipment.
- Do not install a suction line filter drier in the liquid line.
- A factory-approved bi-flow liquid line filter drier is shipped with every unit and must be installed in the liquid line at the time of installation. Only manufacturer-approved liquid line filter driers should be used. Filter driers must have a working pressure rating of at least 600 psig [4,137 kPa]. The filter drier will only have adequate moisture-holding capacity if the system is properly evacuated.
- Desiccant (drying agent) must be compatible for POE oils and R-410A refrigerant.

4.0 INSTALLATION



4.2 Choosing a Location

4.2.1 Allowable Clearances

- 12" to side intake louvers
- 24" to service access panels
- 60" vertical for fan discharge

If space limitations exist, the following clearances will have minimal impact to capacity and efficiency and are permitted:

Single-Unit Applications: Minimum of 6" to side intake louvers. **DO NOT** reduce the 60" [152.4 cm] for fan discharge or the 24" [61.0 cm] service clearances.

Multiple-Unit Applications: For units positioned next to each other, a minimum of 6" [15.2 cm] clearance between units is recommended for 2 ton models and 9" [22.9 cm] for 3 ton to 5 ton models. Do not reduce the 60" [152.4 cm] for fan discharge or the 24" [61.0 cm] service clearances.

IMPORTANT: Consult local and national building codes and ordinances for special installation requirements. Following location information will provide longer life and simplified servicing of the outdoor heat pump.

NOTICE: These units must be installed outdoors. No ductwork can be attached, or other modifications made, to the discharge grille. Modifications will affect performance or operation.

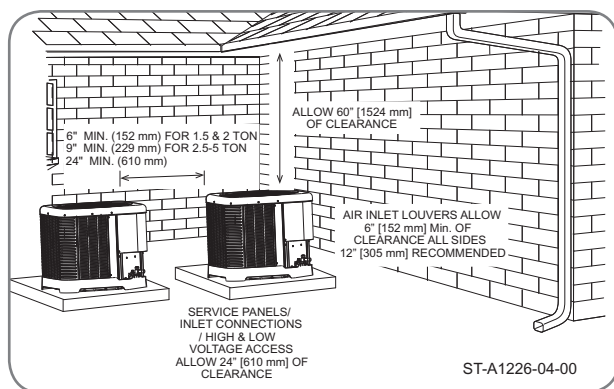

4.2.2 Operational Issues Related to Unit Location

IMPORTANT: Locate the unit in a manner that will not prevent, impair, or compromise the performance of other equipment installed in proximity to the unit. Maintain all required minimum distances to gas and electric meters, dryer vents, and exhaust and inlet openings. In the absence of national codes or manufacturers' recommendations, local code recommendations and requirements will take precedence.

- Refrigerant piping and wiring should be properly sized and kept as short as possible to avoid capacity losses and increased operating costs.
- Locate the unit where water runoff will not create a problem with the equipment. Position the unit away from the drip edge of the roof whenever possible. Units are weatherized, but can be affected by the following:
 - Water pouring into the unit from the junction of rooflines, without protective guttering. Large volumes of water entering the heat pump while in operation can impact fan blade or motor life, and coil damage may occur to a heat pump if moisture cannot drain from the unit under freezing conditions.
 - Freezing moisture or sleeting conditions can cause the cabinet to ice-over prematurely and prevent heat pump operation, requiring backup heat, which generally results in less economical operation. It is highly recommended to switch the EcoNet™ Control Center or thermostat to the "Emergency Heat" mode during freezing rain or sleeting conditions to prevent damage to the outdoor coil from ice accumulating on the fan blade.
- Closely follow the clearance recommendations in section 4.2.1.
 - 24" [61.0 cm] to the service panel access.
 - 60" [152.4 cm] above the fan discharge (unit top) to prevent recirculation.
 - 6" [15.2 cm] to the coil grille air inlets with 12" [30.5 cm] minimum recommended.

4.0 INSTALLATION



4.2 Choosing a Location (cont.)

4.2.3 Corrosive Environment

The metal parts of this unit may be subject to rust or deterioration if exposed to a corrosive environment. This oxidation could shorten the equipment's useful life.

Corrosive elements include, but are not limited to, salt spray, fog or mist in seacoast areas, sulphur or chlorine from lawn watering systems, and various chemical contaminants from industries such as paper mills and petroleum refineries.

If the unit is to be installed in an area where contaminants are likely to be a problem, special attention should be given to the equipment location and exposure.

- Avoid having lawn sprinkler heads spray directly on the unit cabinet.
- In coastal areas, locate the unit on the side of the building away from the waterfront.
- Shielding provided by a fence or shrubs may give some protection, but cannot violate minimum airflow and service access clearances.

⚠ WARNING: Disconnect all power to unit before starting maintenance. Failure to do so can cause electrical shock resulting in severe personal injury or death.

Regular maintenance will reduce the buildup of contaminants and help to protect the unit's finish.

- Frequent washing of the cabinet, fan blade, and coil with fresh water will remove most of the salt or other contaminants that build up on the unit.
- Regular cleaning and waxing of the cabinet with a good automobile polish will provide some protection.
- A good liquid cleaner may be used several times a year to remove matter that will not wash off with water.

4.2.4 Customer Satisfaction Issues

- The heat pump should be located away from the living, sleeping, and recreational spaces of the owner and those spaces on adjoining property.
- To prevent noise transmission, the mounting pad for the outdoor unit should not be connected to the structure and should be located a sufficient distance above grade to prevent ground water from entering the unit.

4.3 Unit Mounting

4.3.1 Unit Mounting Methods

The outdoor heat pump unit may be mounted in a number of ways. The most common method is on the ground mounted on a concrete or pre-fabricated pad. It can also be mounted on a ground or roof mounted metal frame, wooden frame, or 4" x 4" wooden stringers. It is extremely important to properly secure the unit to the pad or frame so it does not shift during high winds, seismic events, or other outside forces to eliminate the possibility of a safety hazard or physical damage to the unit. Local codes in regions subject to frequent hurricanes and seismic events will dictate specific mounting requirements and must be followed. It is also important to elevate the heat pump in areas that receive a significant amount of snowfall so accumulated snow does not block the outdoor coil and interfere with drainage of water during the defrost cycle. Refer to Section 4.3.4 for typical ground snow levels for different regions of the USA.

4.3.2 High Wind and Seismic Tie-Down Methods

The manufacturer-approved/recommended method is a guide to securing equipment for wind and seismic loads. Other methods might provide the same result, but the manufacturer method is the only one endorsed by the manufacturer for securing equipment where wind or earthquake damage can occur. Additional information is available in the PTS (Product Technical Support) section of the manufacturer's Web sites MyRheem.com, or MyRuud.com and can be found as a listing under each outdoor model. If you do not have access to this site, your distributor can offer assistance.

4.0 INSTALLATION

4.3.3 Elevating Unit

⚠ WARNING: Secure an elevated unit and its elevating stand in order to prevent tipping. Failure to do so may result in severe personal injury or death.

If elevating the heat pump, either on a flat roof or on a slab, observe the following guidelines.

- If elevating a unit on a flat roof, use 4" x 4" [10.2 cm x 10.2 cm] or equivalent stringers positioned to distribute unit weight evenly and prevent noise and vibration.
- Where snowfall is anticipated, raise the unit above the base pad to prevent ice buildup and coil damage. Mount the unit high enough to be above the average accumulated area snowfall. See "Ground Snow Depth" chart below for representative snow depths.

NOTICE: Do not block drain openings on bottom of unit.

- If unit must be elevated because of anticipated snowfall, secure unit and elevating stand such that unit and/or stand will not tip over or fall off. Keep in mind that someone may try to climb on unit.

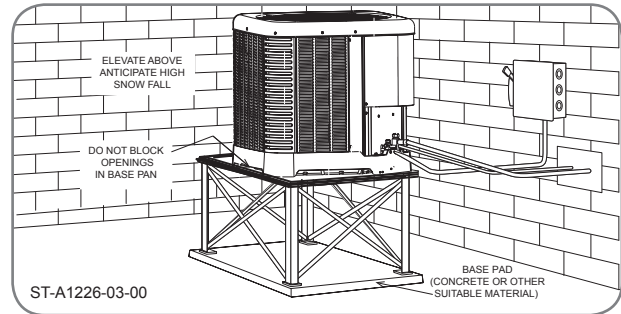

4.3.4 Ground Snow Depth Table

GROUND SNOW DEPTH - INCHES

ALABAMA		INDIANA		MINNESOTA		NEW MEXICO		PENNSYLVANIA		VIRGINIA	
Huntsville	7	Evansville	12	Duluth	64	Albuquerque	4	Allentown	23	Dulles Airport	19
ARIZONA		Fort Wayne	17	International Falls	43	Clayton	10	Erie	19	Lynchburg	16
Flagstaff	48	Indianapolis	21	Minneapolis/St. Paul	50	Roswell	8	Harrisburg	23	National Airport	18
Prescott	3	South Bend	44	Rochester	50	NEW YORK		Philadelphia	16	Norfolk	9
Winslow	7	IOWA		St. Cloud	53	Albany	25	Pittsburgh	22	Richmond	12
ARKANSAS		Burlington	17	MISSISSIPPI		Binghamton	35	Scranton	16	Roanoke	17
Fort Smith	5	Des Moines	22	Jackson	3	Buffalo	42	Williamsport	20	WASHINGTON	
Little Rock	6	Dubuque	38	MISSOURI		NYC - Kennedy Airport	18	Providence	21	Olympia	24
CALIFORNIA		Sioux City	33	Columbia	21	NYC - LaGuardia Airport	18	South Carolina	21	Quillayute	24
Blue Canyon	25	Waterloo	36	Kansas City	18	Rochester	38	Columbia	12	Seattle-Tacoma	14
Mt. Shasta	69	KANSAS		St. Louis	16	Syracuse	35	Greenville	4	Spokane	41
COLORADO		Concordia	23	Springfield	14	NORTH CAROLINA		Aberdeen	42	Stampede Pass	51
Alamosa	15	Dodge City	12	MONTANA		Asheville	12	Huron	43	Yakima	25
Colorado Springs	14	Goodland	14	Billings	17	Cape Hattaras	5	Rapid City	14	WEST VIRGINIA	
Denver	15	Topeka	19	Glasgow	17	Charlotte	10	Sioux Falls	38	Beckley	51
Grand Junction	16	Wichita	11	Great Falls	16	Greensboro	11	Huntington	15	Charleston	20
Pueblo	7	KENTUCKY		Havre	24	Raleigh-Durham	10	Wilmington	9	Elkins	21
CONNECTICUT		Covington	12	Helena	18	Winston-Salem	17	Bristol	8	Wichita Falls	5
Bridgeport	23	Lexington	12	Kalispell	53	NORTH DAKOTA		Chattanooga	6	Green Bay	36
Hartford	29	Louisville	11	Missoula	23	Bismarck	25	Knoxville	8	La Crosse	32
New Haven	15	MAINE		NEBRASKA		Fargo	34	Memphis	5	Madison	32
DELAWARE		Caribou	100	Grand Island	30	Fargo	34	Nashville	8	Madison	32
Wilmington	13	Portland	62	Lincoln	20	Williston	25	Nashville	8	Milwaukee	32
GEORGIA		Norfolk	29	OHIO		TEXAS		WYOMING		Casper	10
Athens	5	Baltimore	17	Akron-Canton	15	Abilene	6	Cheyenne	15	Lander	20
Macon	8	MARYLAND		Cleveland	16	Amarillo	10	Sheridan	25	Sheridan	25
IDAHO		Boston	30	Columbus	10	Dallas	3	Fort Worth	6	Chicago O'Hare	18
Boise	6	Nantucket	18	Dayton	11	El Paso	5	Lubbock	10	Chicago	22
Lewiston	9	Worcester	35	Mansfield	17	Fort Worth	6	Midland	2	Moline	17
Pocatello	7	MICHIGAN		Toledo Express	8	Lubbock	10	San Antonio	3	Peoria	16
ILLINOIS		Alpena	53	Youngstown	12	Wichita Falls	5	Wichita Falls	5	Rockford	25
Chicago O'Hare	18	Detroit City	9	OKLAHOMA		Utah	16	Salt Lake City	8	Springfield	23
Chicago	22	Detroit Airport	17	Tulsa	8	Milford	16	Wendover	3		
Springfield	23	Detroit - Willow Run	21	OREGON		Salt Lake City	8	Burlington	37		
Peoria	16	Flint	28	Burns City	24	Wendover	3				
Rockford	25	Grand Rapids	37	Eugene	17						
Springfield	23	Houghton Lake	56	Medford	8						
		Lansing	42	Pendleton	11						
		Marquette	53	Portland	10						
		Muskegon	43	Salem	7						
		Sault Ste. Marie	80								

NOTICE: Local records and experience must be considered when establishing the unit installation height. There is a 2% probability that the ground snow depth shown in this table will be exceeded annually. Drifts have not been considered. This data represents 184 National Weather Service locations at which measurements are made and assumes a nationwide snow density of 12 lb./ft.³



4.4 Refrigerant Line Set Selection

4.4.1 Replacing Existing Systems

To prevent failure of a new unit, the existing line set must be correctly sized for the new unit and must be cleaned or replaced. Care must be taken so the expansion device is not plugged. For new and replacement units, a liquid line filter drier must be installed and the line set must be properly sized. Test the oil for acid. If it tests positive for acid, a suction line filter drier is mandatory.

IMPORTANT: When replacing an R-22 unit with an R-410A unit, either replace the line set or ensure that residual mineral oil is drained from existing lines including oil trapped in low spots.

4.4.2 Line Set Application Considerations

The following are special considerations that need to be addressed when selecting and installing a line set.

- Additional refrigerant charge
- Fitting losses and maximum equivalent length considerations
- Refrigerant migration during the off cycle
- Oil return to the compressor
- Capacity losses
- System oil level adjustment

4.4.2.1 Oil Return to Compressor

Small amounts of compressor crankcase oil is picked up and carried out of the compressor by the moving refrigerant and is circulated through the system along with the refrigerant before it returns to the compressor crankcase. It is critical to the life of the compressor for the oil to be able to return to the compressor to maintain an adequate level of oil in the compressor crankcase. Oversized vapor lines result in inadequate refrigerant velocities to carry the oil along with the refrigerant and will cause the oil to accumulate in the low spots in the vapor line instead of being returned to the compressor crankcase. This is especially true for long line lengths. Variable speed systems present an additional challenge due to the fact that the system operates at a significantly reduced refrigerant flow rate for a significant percentage of operating time. Only use the vapor line sizes listed in Table 2 to assure proper oil return. **DO NOT** oversize vapor line!

4.4.2.2 Refrigerant Migration During Off Cycle

Long line set applications can require a considerable amount of additional refrigerant. This additional refrigerant needs to be managed throughout the entire ambient operating envelope that the system will go through during its life cycle. Off-Cycle migration is where excess refrigerant condenses and migrates to the coldest and/or lowest part of the system. Excessive build-up of refrigerant at the compressor will result in poor reliability and noisy operation during startup. Section 4.5.2 demonstrates the required unit configuration for different applications.

The outdoor unit controls can energize a portion of the compressor motor stator as needed during the off cycle to prevent liquid refrigerant from accumulating inside the compressor, similar to how a crankcase heater functions on conventional systems.

4.4.2.3 Maximum Liquid Pressure Drop

The total liquid line pressure drop must not exceed 50 psig [345 kPa] to assure a solid column of liquid at the metering device and stable control of superheat. Be sure to account for vertical separation, elbows, filter driers, solenoid valves, sight glasses, and check valves when calculating liquid line pressure drop.

4.4.2.4 Liquid Line Refrigerant Flashing

Excessive pressure drop and heat gain in long liquid lines can result in the refrigerant flashing into a vapor before it reaches the expansion device which will dramatically reduce the capacity and efficiency of the system. For this reason, the liquid line must be sized properly using Table 2 and must be insulated in unconditioned spaces.

4.0 INSTALLATION

4.4.2.5 Oil Level Adjustment for Long Line Set Applications

Additional oil will need to be added if refrigerant is added during installation. The following provides the equation for the oil level adjustment and the compressor name plate oil charge for the different outdoor units.

$$\text{Oil to be Added} = [(\text{Charge Adjustment} + \text{OD Unit Name Plate Refrigerant Charge (oz.)}) \times (0.022) - [(0.10) \times (\text{Compressor Name Plate Oil Charge (oz.)})]$$

Example: An application requires 125 ft of line set with a liquid line diameter of 3/8", Charge Adjustment = 66 oz., Name Plate Charge = 212 oz., Name Plate Oil Charge = 40 oz., Oil to be Added = ((66 oz. + 212 oz.) × .022) – (.10 × 40 oz.) = 2 oz.

OD Model	Compressor	Nameplate Oil Charge oz [ml]
(-)P2024	ZPV0212E-ZE9-130	40 [1,183]
(-)P2036 (-)P2048	ZPV0342E-ZE9-130	40 [1,183]
(-)P2060	ZPV038CE-ZE9-130	40 [1,183]

4.4.2.6 Capacity Losses

Long line lengths can result in a reduction in capacity due to vapor line pressure drop and heat gain or loss. Refer to Table 2 for capacity loss multipliers for various vapor line diameters and equipment line lengths. This table does not account for any capacity loss due to heat gain or loss from the environment. It is extremely important not to oversize the vapor line to minimize capacity loss at the expense of proper oil return. If the table shows an "NR" for a particular vapor line diameter and length, or, if a vapor line diameter is not listed, oil return will not be adequate.

4.4.3 Line Set Length and Fitting Losses

Refrigerant tubing is measured in terms of actual length and equivalent length. Actual length is used for refrigerant charge applications. Equivalent length takes into account pressure losses from tub-

ing length, fittings, vertical separation, accessories, and filter driers. The table below references different commonly used equivalent lengths.

Table 1

Equivalent Length for Fittings: ft [m]							
Line Size in [mm]	90° Short Radius Elbow	90° Long Radius Elbow	45° Elbow	Solenoid Valve	Check Valve	Sight Glass	Filter Drier
3/8 [9.53]	1.3 [0.40]	0.8 [0.24]	0.3 [0.09]	6 [1.83]	4 [1.22]	0.4 [0.12]	6 [1.83]
1/2 [12.71]	1.4 [0.43]	0.9 [0.27]	0.4 [0.12]	9 [2.74]	5 [1.52]	0.6 [0.18]	6 [1.83]
5/8 [15.88]	1.5 [0.46]	1 [0.30]	0.5 [0.15]	12 [3.66]	6 [1.83]	0.8 [0.24]	6 [1.83]
3/4 [19.05]	1.9 [0.58]	1.3 [0.40]	0.6 [0.18]	14 [4.27]	7 [2.13]	0.9 [0.27]	6 [1.83]
7/8 [22.23]	2.3 [0.70]	1.5 [0.46]	0.7 [0.21]	15 [4.57]	8 [2.44]	1 [0.30]	6 [1.83]
1-1/8 [28.58]	2.7 [0.82]	1.8 [0.55]	0.9 [0.27]	22 [6.71]	12 [3.66]	1.5 [0.46]	6 [1.83]

4.0 INSTALLATION

4.4.4 Liquid Line Selection

The purpose of the liquid line is to transport warm sub-cooled liquid refrigerant between the outdoor unit to the indoor unit in the cooling mode. In the heating mode, the liquid line returns sub-cooled liquid from the indoor unit to the outdoor unit. It is important not to allow the refrigerant to flash into superheated vapor prior to entering the expansion device of the indoor coil or outdoor unit. Flashing of refrigerant can occur for the following reasons:

- Low refrigerant charge
- Improperly selected liquid line size
- Absorption of heat prior to expansion device
- Excessive vertical separation between the outdoor unit and indoor coil
- Restricted liquid linear filter drier
- Kinked liquid line

The total pressure drop allowed for the liquid line is 50 PSI [345 kPa]. The procedure for selecting the proper liquid line is as follows:

- Measure the total amount of vertical separation

between the outdoor unit and indoor coil.

- Measure the total indoor length of liquid line required.
- Add all of the equivalent lengths associated with any fittings or accessories using Table 1.
- Add the linear length to the total fitting equivalent length. This will equal your total equivalent line length.
- Reference Table 2 to verify the calculated equivalent length is acceptable with the required vertical separation and diameter of liquid line.

Example: A 3-ton heat pump unit is installed 25' below the indoor unit, requires a 75' of 1/2" diameter liquid line, 3/4" vapor line, 4 90° LR elbows and a filter drier.

- Fitting Equivalent Length (ft.) = $4 \times .9' + 6' = 9.6'$
 - Total Equivalent Length (ft.) = $75' + 9.6' = 84.6'$
- This application is acceptable because the 25' vertical rise is less than the maximum rise of 50' for this application.

Unit Size	Allowable Liquid Line Size	Allowable Vapor Line Size	Outdoor Unit ABOVE or BELOW Indoor Unit					
			Equivalent Length (Feet)					
			<25	26-50	51-75	76-100	101-125	126-150
Maximum Vertical Separation / Capacity Multiplier								
3 Ton	5/16"	5/8"	25 / 0.99	50 / 0.97	50 / 0.95	50 / 0.93	36 / 0.91	NR
	3/8"	5/8"	25 / 0.99	50 / 0.97	50 / 0.95	50 / 0.93	50 / 0.91	NR
	5/16"	3/4"	25 / 1.00	50 / 0.99	50 / 0.99	50 / 0.98	36 / 0.97	20 / 0.96
	3/8"	3/4"	25 / 1.00	50 / 0.99	50 / 0.99	50 / 0.98	50 / 0.97	50 / 0.96
	1/2"	3/4"	25 / 1.00	50 / 0.99	50 / 0.99	50 / 0.98	50 / 0.97	50 / 0.96

(Excerpt from Table 2A)

4.4.5 Vapor Line Selection

The purpose of the vapor line is to return superheated vapor to the condensing unit from the indoor coil in the cooling mode. While in the heating mode, the vapor line transports discharge vapor to the indoor coil from the outdoor unit. Proper vapor line sizing is important because it plays an important role in returning oil to the compressor to prevent potential damage to the bearings, valves, and scroll sets. Also, an improperly sized vapor line can dramatically reduce capacity and performance of the system. The procedure for selecting the proper vapor line is as follows:

- Determine the total linear length of vapor line required.
- Add all of the equivalent lengths associated with any fittings or accessories using Table 1.
- Add the linear length and total fitting equivalent length. This will equal your total equivalent line length.
- Reference Table 2 to verify that the calculated equivalent length falls within the compatibility region of the chart.
- Verify capacity loss is acceptable for the application.

4.0 INSTALLATION

Table 2A: Refrigerant Line Sizing Chart (English Units)

20 SEER Variable Speed Heat Pumps								
Unit Size	Allowable Liquid Line Size	Allowable Vapor Line Size	Outdoor Unit ABOVE or BELOW Indoor Unit Equivalent Length (Feet)					
			< 25	26-50	51-75	76-100	101-125	126-150
			Maximum Vertical Separation / Capacity Multiplier					
2.0 Ton * SEE NOTE 3	1/4"	5/8"	25 / 1.00	50 / 0.99	33 / 0.98	6 / 0.97	NR	NR
	5/16"	5/8"	25 / 1.00	50 / 0.99	50 / 0.98	50 / 0.97	50 / 0.96	50 / 0.95
	3/8"	5/8"	25 / 1.00	50 / 0.99	50 / 0.98	50 / 0.97	50 / 0.96	50 / 0.95
	1/4"	3/4" *	25 / 1.00	50 / 1.00	33 / 0.99	6 / 0.99	NR	NR
	5/16"	3/4" *	25 / 1.00	50 / 1.00	50 / 0.99	50 / 0.99	50 / 0.99	50 / 0.98
	3/8"	3/4" *	25 / 1.00	50 / 1.00	50 / 0.99	50 / 0.99	50 / 0.99	50 / 0.98
3 Ton	5/16"	5/8"	25 / 0.99	50 / 0.97	50 / 0.95	50 / 0.93	36 / 0.91	NR
	3/8"	5/8"	25 / 0.99	50 / 0.97	50 / 0.95	50 / 0.93	50 / 0.91	NR
	5/16"	3/4"	25 / 1.00	50 / 0.99	50 / 0.99	50 / 0.98	36 / 0.97	20 / 0.96
	3/8"	3/4"	25 / 1.00	50 / 0.99	50 / 0.99	50 / 0.98	50 / 0.97	50 / 0.96
	1/2"	3/4"	25 / 1.00	50 / 0.99	50 / 0.99	50 / 0.98	50 / 0.97	50 / 0.96
4 Ton	3/8"	3/4"	25 / 0.99	50 / 0.98	50 / 0.96	50 / 0.95	50 / 0.93	50 / 0.92
	1/2"	3/4"	25 / 0.99	50 / 0.98	50 / 0.96	50 / 0.95	50 / 0.93	50 / 0.92
	3/8"	7/8"	25 / 1.00	50 / 0.99	50 / 0.99	50 / 0.98	50 / 0.98	50 / 0.97
	1/2"	7/8"	25 / 1.00	50 / 0.99	50 / 0.99	50 / 0.98	50 / 0.98	50 / 0.97
5 Ton **SEE NOTE 4	3/8"	3/4"	25 / 0.98	50 / 0.97	50 / 0.95	50 / 0.93	46 / 0.91	NR
	1/2"	3/4"	25 / 0.98	50 / 0.97	50 / 0.95	50 / 0.93	50 / 0.91	NR
	3/8"	7/8"	25 / 0.99	50 / 0.99	50 / 0.98	50 / 0.97	50 / 0.96	38 / 0.95
	1/2"	7/8"	25 / 0.99	50 / 0.99	50 / 0.98	50 / 0.97	50 / 0.96	50 / 0.95
	3/8"	1-1/8" **	25 / 1.00	50 / 1.00	50 / 1.00	50 / 0.99	50 / 0.99	38 / 0.99
	1/2"	1-1/8" **	25 / 1.00	50 / 1.00	50 / 1.00	50 / 0.99	50 / 0.99	50 / 0.99

Notes:

- 1) Do not exceed 150 ft linear line length.
- 2) Do not exceed 50 ft vertical separation between indoor and outdoor units.
- 3) * 3/4" vapor line should only be used for 2 ton systems if outdoor unit is below or at same level as indoor unit to assure proper oil return.
- 4) ** 1-1/8" vapor line should only be used for 5 ton systems if outdoor unit is below or at same level as indoor unit to assure proper oil return.
- 5) Always use the smallest liquid line allowable to minimize refrigerant charge.
- 6) Applications shaded in light gray indicate capacity multipliers between 0.90 and 0.96 which are not recommended, but are allowed.
- 7) Applications shaded in dark gray are not recommended due to excessive liquid or suction pressure drop.

4.0 INSTALLATION

Table 2B: Refrigerant Line Sizing Chart (Metric Units)

20 SEER Variable Speed Heat Pumps								
Unit Size	Allowable Liquid Line Size mm [in.]	Allowable Vapor Line Size mm [in.]	Outdoor Unit ABOVE or BELOW Indoor Unit Equivalent Length (Meters)					
			<8	8-15	16-23	24-30	31-38	39-46
			Maximum Vertical Separation / Capacity Multiplier					
7.0 KW [2.0 Ton] * SEE NOTE 3	6.35 [1/4]	15.88 [5/8]	8 / 1.00	15 / 0.99	10 / 0.98	2 / 0.97	NR	NR
	7.94 [5/16]	15.88 [5/8]	8 / 1.00	15 / 0.99	15 / 0.98	15 / 0.97	15 / 0.96	15 / 0.95
	9.53 [3/8]	15.88 [5/8]	8 / 1.00	15 / 0.99	15 / 0.98	15 / 0.97	15 / 0.96	15 / 0.95
	6.35 [1/4]	19.05 [3/4] *	8 / 1.00	15 / 0.99	10 / 0.99	2 / 0.99	NR	NR
	7.94 [5/16]	19.05 [3/4] *	8 / 1.00	15 / 0.99	15 / 0.99	15 / 0.99	15 / 0.99	15 / 0.98
10.6 KW [3 Ton]	7.94 [5/16]	15.88 [5/8]	8 / 0.99	15 / 0.97	15 / 0.95	15 / 0.93	11 / 0.91	NR
	9.53 [3/8]	15.88 [5/8]	8 / 0.99	15 / 0.97	15 / 0.95	15 / 0.93	15 / 0.91	NR
	7.94 [5/16]	19.05 [3/4]	8 / 1.00	15 / 0.99	15 / 0.99	15 / 0.98	11 / 0.97	6 / 0.96
	9.53 [3/8]	19.05 [3/4]	8 / 1.00	15 / 0.99	15 / 0.99	15 / 0.98	15 / 0.97	15 / 0.96
	12.7 [1/2]	19.05 [3/4]	8 / 1.00	15 / 0.99	15 / 0.99	15 / 0.98	15 / 0.97	15 / 0.96
14.1 KW [4 Ton]	9.53 [3/8]	19.05 [3/4]	8 / 0.99	15 / 0.98	15 / 0.96	15 / 0.95	15 / 0.93	15 / 0.92
	12.7 [1/2]	19.05 [3/4]	8 / 0.99	15 / 0.98	15 / 0.96	15 / 0.95	15 / 0.93	15 / 0.92
	9.53 [3/8]	22.23 [7/8]	8 / 1.00	15 / 0.99	15 / 0.99	15 / 0.98	15 / 0.98	15 / 0.97
	12.7 [1/2]	22.23 [7/8]	8 / 1.00	15 / 0.99	15 / 0.99	15 / 0.98	15 / 0.98	15 / 0.97
17.6 KW [5 Ton] ** SEE NOTE 4	9.53 [3/8]	19.05 [3/4]	8 / 0.98	15 / 0.97	15 / 0.95	15 / 0.93	14 / 0.91	NR
	12.7 [1/2]	19.05 [3/4]	8 / 0.98	15 / 0.97	15 / 0.95	15 / 0.93	15 / 0.91	NR
	9.53 [3/8]	22.23 [7/8]	8 / 0.99	15 / 0.99	15 / 0.98	15 / 0.97	15 / 0.96	12 / 0.95
	12.7 [1/2]	22.23 [7/8]	8 / 0.99	15 / 0.99	15 / 0.98	15 / 0.97	15 / 0.96	15 / 0.95
	9.53 [3/8]	28.58 [1-1/8] **	8 / 1.00	15 / 1.00	15 / 1.00	15 / 0.99	15 / 0.99	12 / 0.99
	12.7 [1/2]	28.58 [1-1/8] **	8 / 1.00	15 / 1.00	15 / 1.00	15 / 0.99	15 / 0.99	15 / 0.99

Notes:

- 1) Do not exceed 46 meters linear line length.
- 2) Do not exceed 15 meters vertical separation between indoor and outdoor units.
- 3) * 19.05mm [3/4 in.] vapor line should only be used for 2 ton systems if outdoor unit is below or at same level as indoor unit to assure proper oil return.
- 4) ** 28.58mm [1-1/8 in.] vapor line should only be used for 5 ton systems if outdoor unit is below or at same level as indoor unit to assure proper oil return.
- 5) Always use the smallest liquid line allowable to minimize refrigerant charge.
- 6) Applications shaded in light gray indicate capacity multipliers between 0.90 and 0.96 which are not recommended, but are allowed.
- 7) Applications shaded in dark gray are not recommended due to excessive liquid or suction pressure drop.

4.0 INSTALLATION



4.5 Line Set Installation

- If tubing is to be run underground, it must be run in a sealed watertight chase.
- Use care in routing tubing and do not kink or twist. Use a good quality tubing bender on the vapor line to prevent kinking.

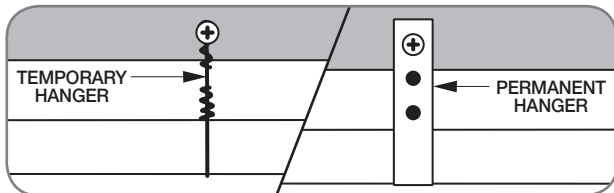

- Route the tubing using temporary hangers; then straighten the tubing and install permanent hangers. The tubing must be adequately supported.
- Isolate the vapor line from the building structure. If the vapor line comes in contact with inside walls, ceiling, or flooring, the vibration of the vapor line

in the heating mode will result in noise inside the structure.

- Blow out the liquid and vapor lines with dry nitrogen before connecting to the outdoor unit and indoor coil to remove debris that can plug the expansion device.

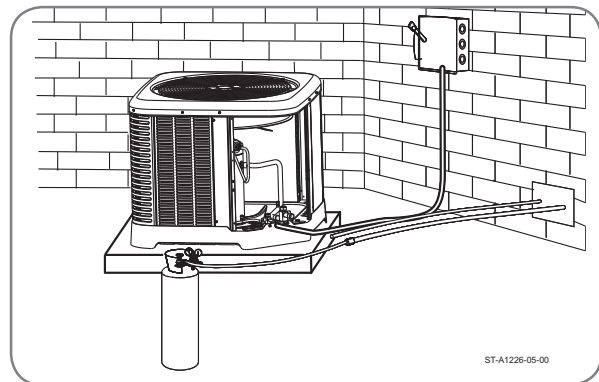

4.5.1 Important Tubing Installation Practices

Observe the following when installing correctly sized type “L” refrigerant tubing between the outdoor unit and indoor coil:

- Check Table 2 for the correct vapor line size and liquid line size.
- **If a portion of the liquid line passes through a very hot area where liquid refrigerant can be heated to form vapor, insulating the liquid line is required.**
- Use clean, dehydrated, sealed refrigeration-grade tubing.
- Always keep tubing sealed until tubing is in place and connections are to be made.
- A high-quality biflow filter drier is included with all R-410A heat pump units and must be installed in the liquid line upon unit installation.
- When replacing an R-22 system with an R-410A system and the line set is not replaced, blow out the lines with dry nitrogen to remove as much of the remaining mineral oil as possible. Check for low spots where oil may be trapped and take measures to drain the oil from those areas.

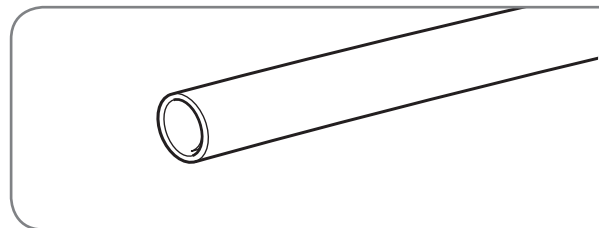

- If tubing has been cut, deburr the ends while holding the tubing in a position to prevent chips from falling into tubing. Burrs such as those caused by tubing cutters can affect performance dramatically, particularly on small diameter liquid lines.
- For best operation, keep tubing run as short as possible with a minimum number of elbows or bends.
- Locations where the tubing will be exposed to mechanical damage should be avoided. If it is necessary to use such locations, the copper tubing should be protected by a housing to prevent damage.

4.0 INSTALLATION



4.5 Line Set Installation (cont.)

4.5.2 Relative Location of Indoor and Outdoor Units

4.5.2.1 Outdoor Unit Level or Near Level to Indoor Coil Line Set

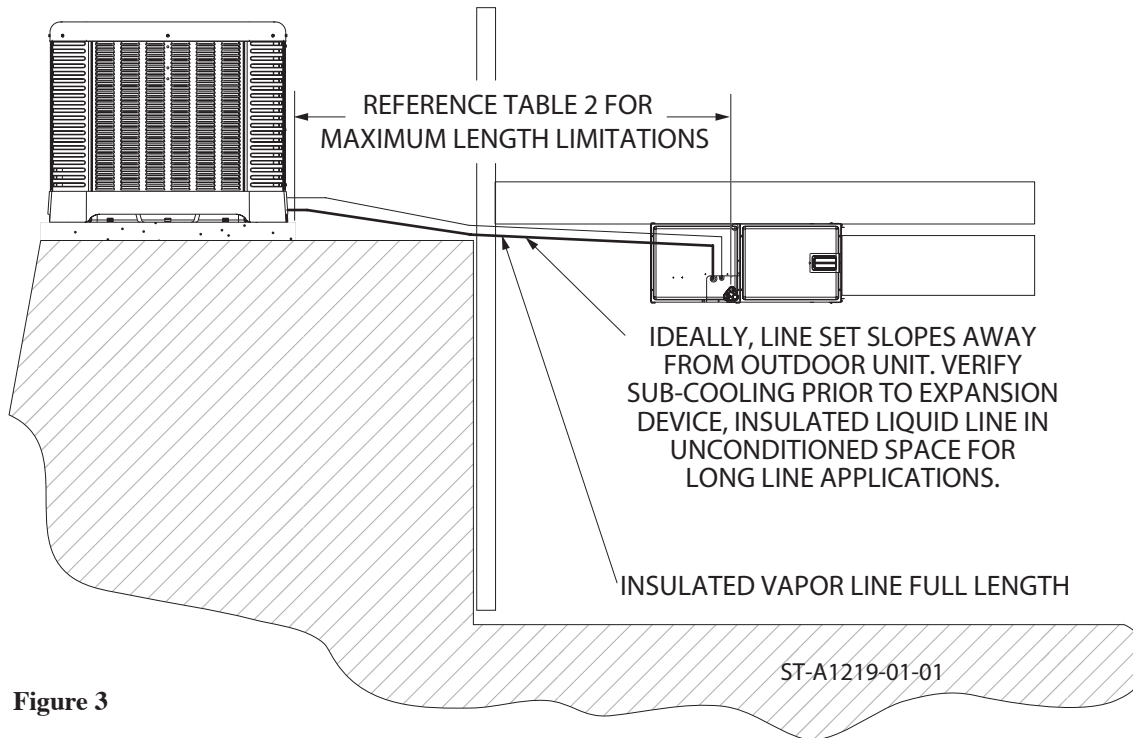

Figure 3

For applications with the outdoor unit and indoor unit on the same level the following is required:

- Insulated liquid line in unconditioned space only.
- Insulated vapor line full length.
- Vapor line should slope toward the indoor unit. (Reference Figure 3)
- Follow the proper line sizing, maximum linear and equivalent length, charging requirements, and oil level adjustments spelled out in this document.
- Verify at least 5°F [2.8°C] sub-cooling at the indoor unit prior to expansion device.

4.0 INSTALLATION

4.5.2.2 Outdoor Unit Below Indoor Coil (Long Line Set Applications)

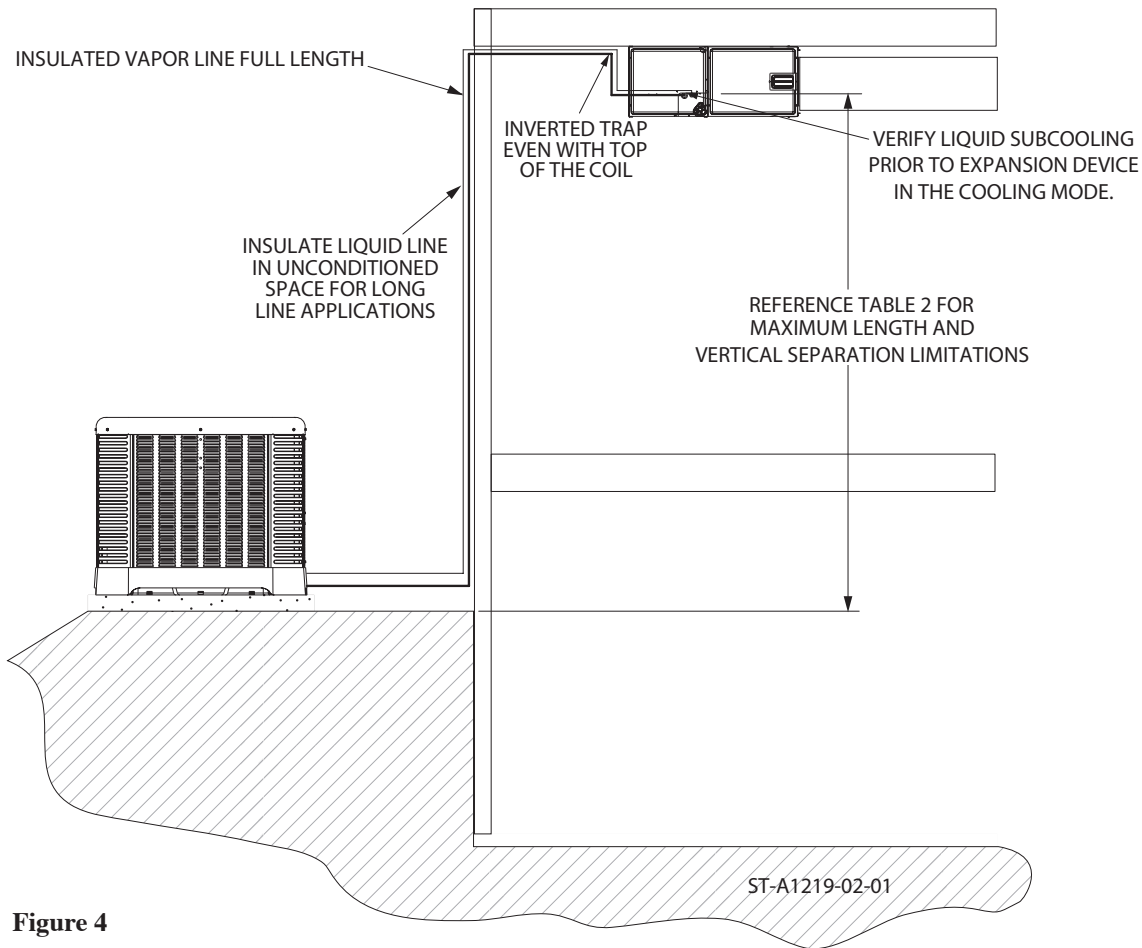

Figure 4

For applications with the outdoor unit below the indoor coil, the following is required:

- Inverted vapor-line trap (Reference Figure 4)
- Insulated liquid line in unconditioned space only.
- Insulated vapor line full length.
- Follow the proper line sizing, maximum linear and equivalent length, maximum vertical separation, charging requirements, and oil level adjustments spelled out in this document.

- Measure pressure at the liquid line service valve and prior to expansion device. Verify that the pressure drop is not greater than 50 PSI [345 kPa].
- For elevations greater than 25' [8 m] a lower subcooling can be expected.
- Verify there is at least 5°F [2.8°C] of liquid subcooling at the indoor coil prior to the expansion device.

4.0 INSTALLATION

4.5.2.3 Outdoor Unit Above Indoor Coil

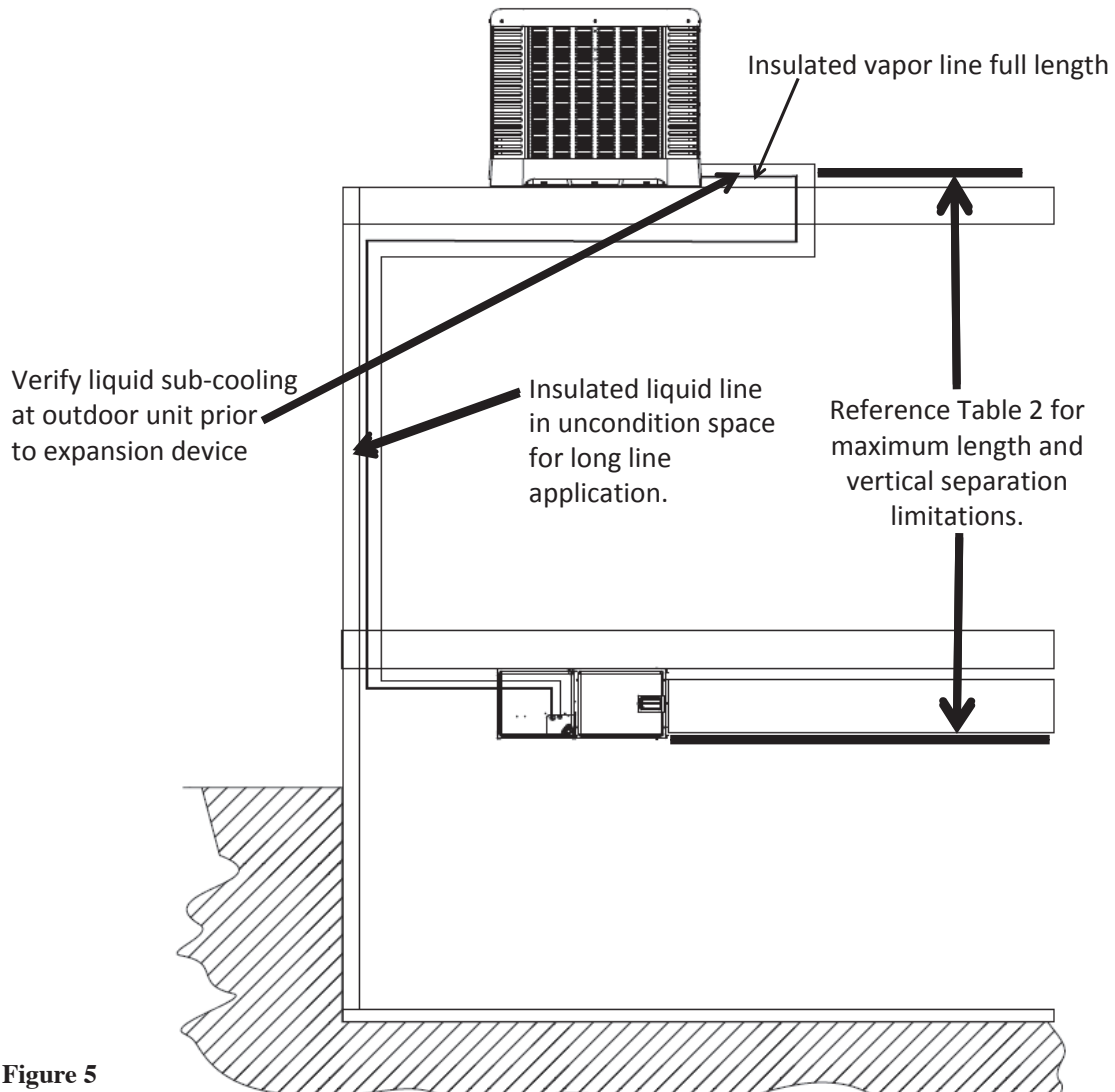

Figure 5

For applications with the outdoor unit above the indoor coil the following is required:

- Insulated liquid line in unconditioned space only.
- Follow the proper line sizing, maximum linear and equivalent length, maximum vertical separation, charging requirements, and oil level adjustments spelled out in this document.
- Insulated vapor line full length.
- Verify at least 5°F [2.8°C] of liquid subcooling at the outdoor unit prior to expansion device in the heating mode.

4.0 INSTALLATION

4.5.3 Tubing Connections

Indoor coils have only a holding charge of dry nitrogen. Keep all tube ends sealed until connections are to be made.

- Use type “L” copper refrigeration tubing. Braze the connections with the following alloys:
 - Copper to copper, 5% silver minimum
 - Copper to steel or brass, 15% silver minimum

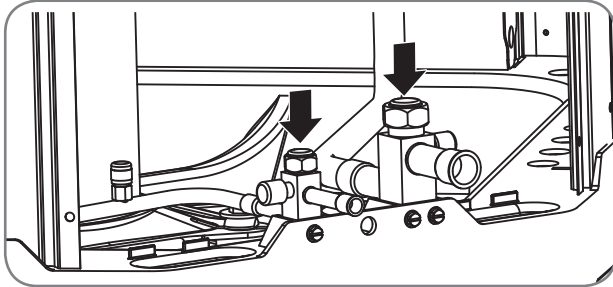

- Be certain both refrigerant shutoff valves at the outdoor unit are closed.

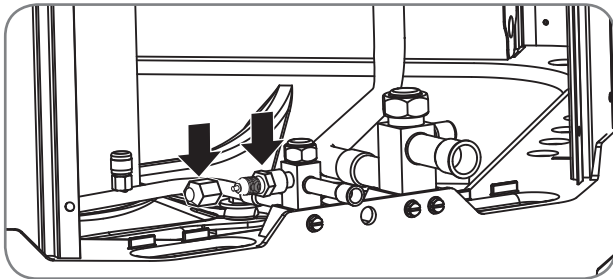

- Remove the caps and Schrader cores from the pressure ports to protect seals from heat damage. Both the Schrader valves and the service valves have seals that may be damaged by excessive heat.

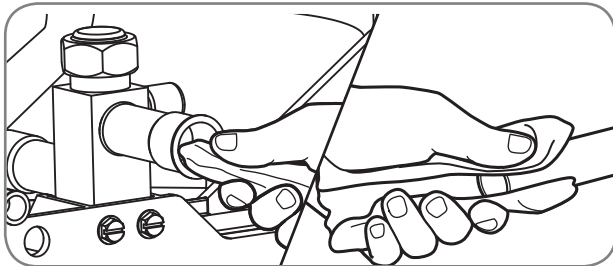

- Clean the inside of the fittings and outside of the tubing with a clean, dry cloth before soldering. Clean out debris, chips, dirt, etc., that enters tubing or service valve connections.

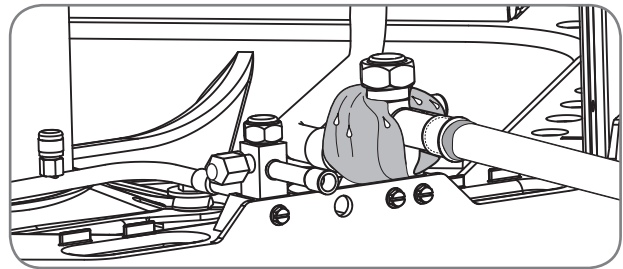

- Wrap valves with a wet rag or thermal barrier compound before applying heat.

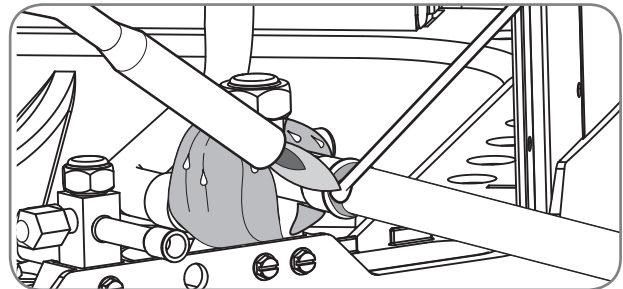

- Braze the tubing between the outdoor unit and indoor coil. Flow dry nitrogen into a pressure port and through the tubing while brazing, but do not allow pressure inside tubing which can result in leaks. Once the system is full of nitrogen, the nitrogen regulator should be turned off to avoid pressuring the system.

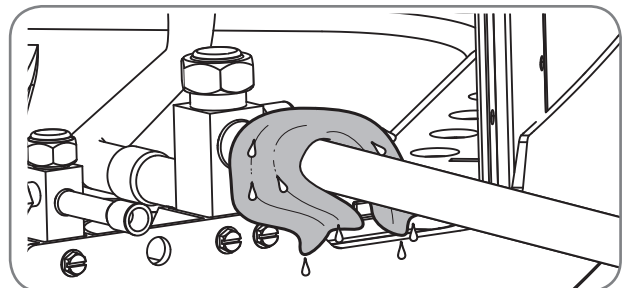

- After brazing, use an appropriate heatsink material to cool the joint.
- Reinstall the Schrader cores into both pressure ports.

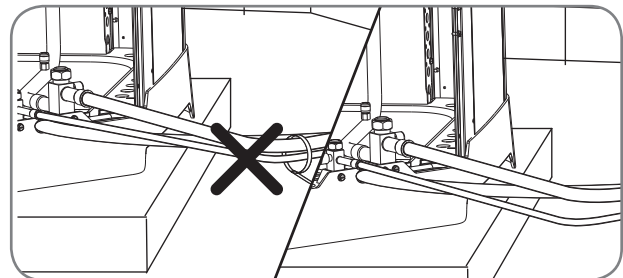

- Do not allow the bare vapor line and liquid line to be in contact with each other. This causes an undesirable heat transfer resulting in capacity loss and increased power consumption.

4.0 INSTALLATION

4.6 Initial Leak Testing

Indoor coils have only a holding charge of dry nitrogen. Keep all tube ends sealed until connections are to be made.

⚠WARNING: Do not use oxygen to purge lines or pressurize system for leak test. Oxygen reacts violently with oil, which can cause an explosion resulting in severe personal injury or death.

The variable speed inverter driven heat pumps are equipped with an EXV and must be matched to indoor coils or air-handlers that are also equipped with EXVs. During shipment, vibration has been found to move the EXV stem valve to a near closed position despite being set to a fully open position in the factory. Prior to leak testing it is recommended to apply power to the indoor and outdoor units, making sure there is no call for operation by disconnecting the EcoNet™ control center or thermostat. By doing this, the controls will immediately close the EXV's followed immediately by opening them to the wide open position, permitting free flow of nitrogen through the system during the brazing process.

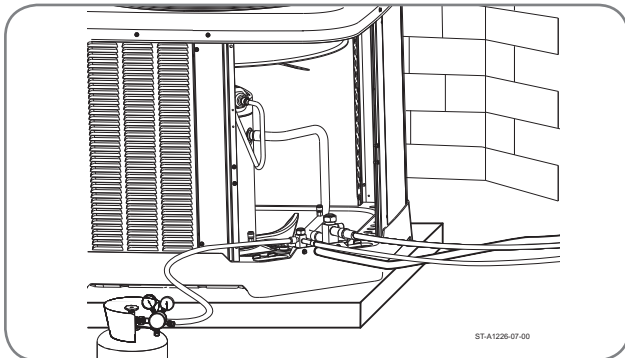

- Pressurize line set and coil through service fittings with dry nitrogen to 150 PSIG (maximum). Close nitrogen tank valve, let system sit for at least 15 minutes, and check to see if the pressure has dropped. If the pressure has dropped, check for leaks at the line set braze joints with soap bubbles and repair leak as necessary. Repeat pressure test. If line set and coil hold pressure, proceed with line set and coil evacuation (see Sections 4.7 and 4.8 for evacuation and final leak testing).

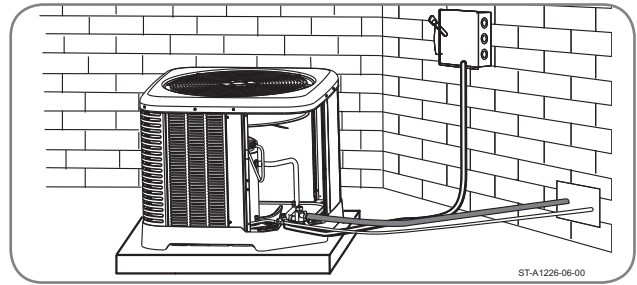

- The vapor line must be insulated for its entire length to prevent dripping (sweating) and prevent performance losses. Closed-cell foam insulation such as Armaflex and Rubatex® are satisfactory insulations for this purpose. Use 1/2" [12.7 mm] minimum insulation thickness. Additional insulation may be required for long runs. The liquid line must be insulated in any unconditioned space when long line sets are used and anytime the liquid line is run through an attic due to hot temperatures that occur there.

4.7 Evacuation

Evacuation is one of the most important parts of the entire installation and service procedure. The life and efficiency of the equipment is dependent upon the thoroughness exercised by the serviceman when evacuating air and moisture from the system.

Air or nitrogen in the system increases condensing temperature and pressure, resulting in increased power consumption, erratic operation, and reduced capacity.

Moisture chemically reacts with the refrigerant and oil to form corrosive acid which attacks the compressor motor windings and internal parts and which can result in compressor failure.

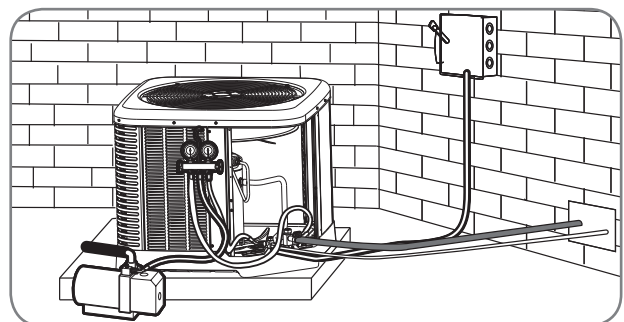

- After the system has been leak-checked and proven sealed, connect the vacuum pump and evacuate system to 500 microns and hold 500 microns or less for at least 15 minutes. The vacuum pump must be connected to both the high and low sides of the system by connecting to the two pressure ports. Use the largest size connections available since restrictive service connections may lead to false readings because of pressure drop through the fittings.

4.0 INSTALLATION

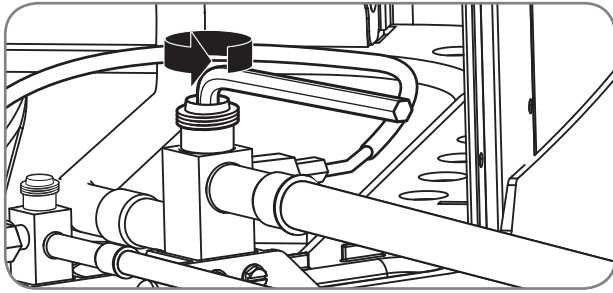

- After adequate evacuation, open both service valves by removing both brass service valve caps with an adjustable wrench. Insert a 3/16" [5 mm] or 5/16" [8 mm] hex wrench into the stem and turn counterclockwise until the wrench stops.

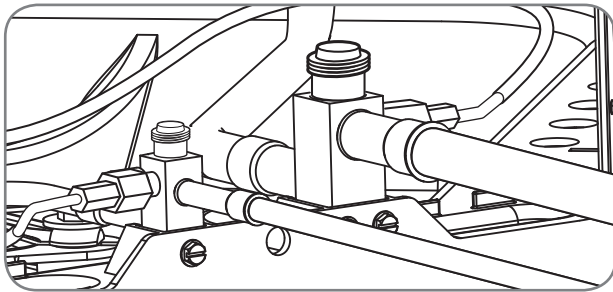

- If not already connected from evacuation process, gauges must be connected at this point to check and adjust charge.

IMPORTANT: Compressors (especially scroll type) should never be used to evacuate the air conditioning system because internal electrical arcing in near vacuum conditions may result in a damaged or failed compressor. Never run a scroll compressor while the system is in a vacuum or compressor failure will occur.

4.8 Final Leak Testing

After the unit has been properly evacuated and service valves opened, a halogen leak detector should be used to detect leaks in the system. All joints and piping within the outdoor unit, evaporator, and interconnecting tubing should be checked for leaks. If a leak is detected, the refrigerant should be recovered before repairing the leak. The Clean Air Act prohibits releasing refrigerant into the atmosphere.

4.9 Control Wiring

⚠WARNING: Turn off electric power at the fuse box or service panel before making any electrical connections. Also, the ground connection must be completed before making line voltage connections. Failure to do so can result in electrical shock, severe personal injury, or death.

4.9.1 EcoNet™ Communications

The EcoNet™ enabled (-)P20 Series heat pumps are specifically designed to be matched with and EcoNet™ enabled air-handler or gas furnace and the EcoNet™ Control Center. While they are also designed to be controlled by a conventional 24VAC 2-stage thermostat, many features and benefits are lost. Therefore, a conventional 24VAC 2-stage thermostat should only be used in temporary emergency situations until communication issues with the EcoNet™ control system are resolved.

4.9.2 EcoNet™ Control Center Installation

The EcoNet™ Control Center should be mounted 4 to 5 feet above the floor on an inside wall of the living room or a hallway that has good air circulation from the other rooms being controlled by the Control Center. It is essential that there be free air circulation at the location of the same average temperature as other rooms being controlled. Movement of air should not be obstructed by furniture, doors, draperies, etc. The Control Center should not be mounted where it will be affected by drafts, hot or cold water pipes or air ducts in walls, radiant heat from fireplace, lamps, the sun, T.V. or an outside wall. See instructions packaged with Control Center for detailed mounting and installation instructions.

4.9.3 EcoNet™ Communication Wiring Connections

The four 18 AWG low-voltage control wires must be installed from the EcoNet™ Control Center to the indoor unit and from the indoor unit to the outdoor unit. The wire length between the Control Center and indoor unit should not be greater than 100 feet [30.5 m].

The wire length between the indoor unit and outdoor unit should not be greater than 125 feet [38.1 m].

Running low-voltage wires in conduit with line voltage power wires is not recommended. Low-voltage wiring must be connected to the low voltage terminal block on the Variable Speed Outdoor Control. The terminal block can be unplugged from the control board to facilitate wiring.

An EcoNet™ communicating heat pump system consists of these matched components:

- EcoNet™ communicating heat pump outdoor unit.
- EcoNet™ communicating air handler or EcoNet™ communicating furnace.
- EcoNet™ Control Center.

4.0 INSTALLATION



4.9 Control Wiring (cont.)

IMPORTANT: The EcoNet™ control system requires continuous 18 AWG thermostat wire. **Do not use phone cord to connect indoor and outdoor units. This will damage the controls.**

The EcoNet™ control system requires four (4) control wires for unit operation:

- R 24 VAC
- C 24 VAC common
- Data wire E1 Communications
- Data wire E2 Communications

The EcoNet™ enabled air handler or furnace is equipped with a 24-volt, 40 or 50 VA transformer for proper system operation. See the wiring diagram below for low voltage wiring connections.

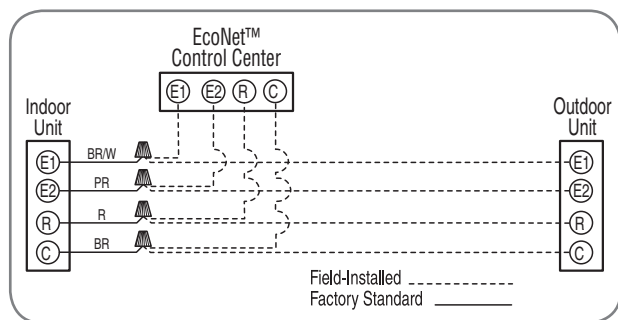

These wires need to be connected to each device (Control Center, indoor air handler or furnace, and outdoor unit).

Once all devices are connected, apply the line voltage to the indoor and outdoor units.

When all devices are powered, the EcoNet™ Control Center should detect the indoor and outdoor units within 45 seconds.

Once the system is powered and all components are communicating with each other, the airflow settings will be automatically configured in the air-handler or furnace.

All adjustments for indoor airflow are made at the EcoNet™ Control Center from this point. Items that can be changed are airflow trim adjustment, on-demand dehumidification, cooling and heating airflow and electric heat airflow. The Control Center also has a wide range of fault and history information. To access any of the control center menus press the settings, status, or service icons at the bottom of the touch screen. Refer to the air handler or furnace installation manual and the EcoNet™ Control Center installation manual for further details on setting up the system and available adjustment options.

4.9.4 Conventional 24VAC Thermostat Control Wiring Connections

The (-)P20**B series of heat pumps allow the installer to use conventional 24 VAC control wiring and a conventional thermostat for limited unit operation. The system will operate as a single stage system at nominal capacity.

IMPORTANT: The preferred method of unit installation and operation is by the EcoNet™ Communicating System which allows access to the fault history of the system. This diagnostic information is not available at the thermostat when the (-)P20 unit is using a conventional thermostat.

Thermostat control wiring requires a minimum of five (5) wires for proper unit operation:

- R – 24 VAC
- C – 24 VAC common
- Y1 – Nominal capacity operation
- B – Heat pump operation
- W – Supplemental Heat During Defrost Cycle

The following figures show the typical control wiring diagrams with (-)P20 heat pumps using a conventional 24VAC thermostat. Cooling and heating airflow levels will need to be adjusted for homeowner comfort once the system is operational. Use DIP switches on the air-handler or furnace control board to adjust indoor air-flow.

WIRE COLOR CODE		
BK – BLACK	GY – GRAY	W – WHITE
BR – BROWN	O – ORANGE	Y – YELLOW
BL – BLUE	PR – PURPLE	
G – GREEN	R – RED	

TYPICAL SINGLE-STAGE THERMOSTAT: (-)P20 HEAT PUMP WITH AIR-HANDLER USING A THERMOSTAT WITH DEHUMIDIFICATION

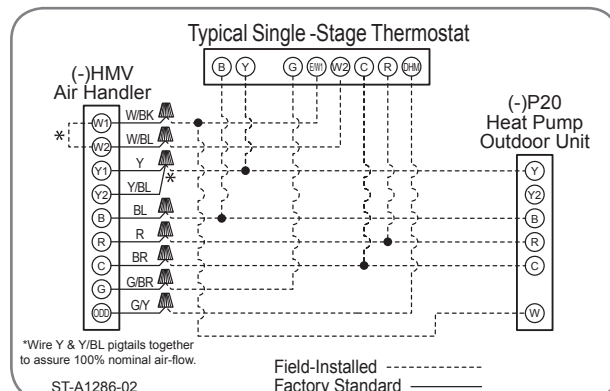

4.0 INSTALLATION



4.9 Control Wiring (cont.)



4.10 Power Wiring

TYPICAL SINGLE-STAGE THERMOSTAT: HEAT PUMP WITH AIR-HANDLER

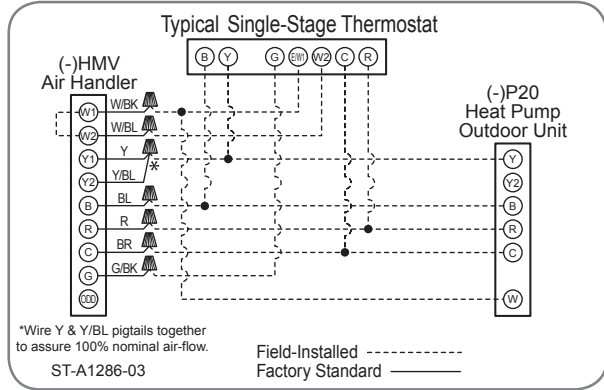

TYPICAL SINGLE-STAGE THERMOSTAT AND DUAL-FUEL APPLICATION

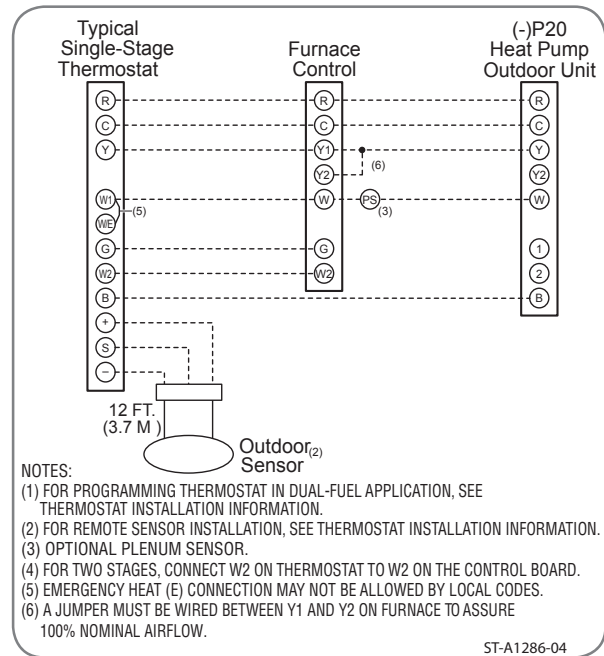

It is important that proper electrical power is available at the heat pump power terminal block. The acceptable operating voltage range is shown below.

VOLTAGE RANGES (60 HZ)

Nameplate Voltage	Operating Voltage Range at Maximum Load Conditions
208/230 (1 Phase)	197-253

Install a branch circuit disconnect within sight of the unit and of adequate size to handle the minimum circuit ampacity (MCA) current (see "Electrical Data" in Section 3.2).

Field wiring must comply with the National Electric Code (C.E.C. in Canada) and any applicable local code.

Power wiring must be run in a rain-tight conduit. Conduit must be attached to the hole in the bottom of the control box.

Connect power wiring to line-voltage lugs on the terminal block located in the outdoor heat pump unit electrical box. (See wiring diagram attached to unit access panel.)

Check all electrical connections, including factory wiring within the unit and make sure all connections are tight.

DO NOT connect aluminum field wire to the line voltage terminal block.

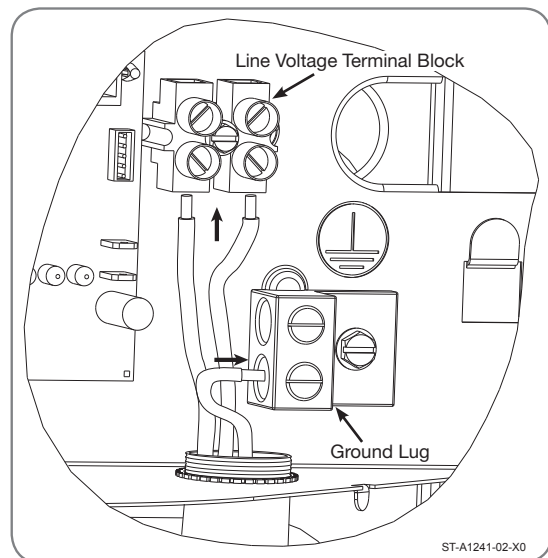

4.0 INSTALLATION



4.11 Grounding

⚠WARNING: The unit must be permanently grounded. Failure to do so can cause electrical shock resulting in severe personal injury or death.

A ground lug is provided near the line-voltage power entrance for a ground wire.

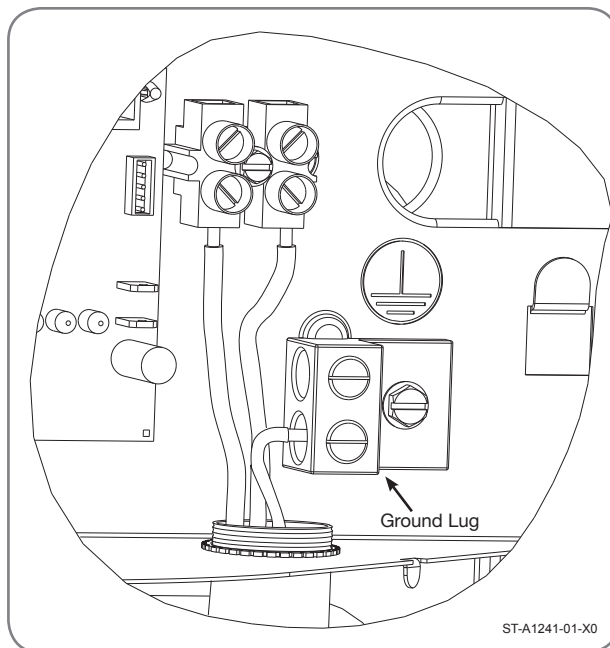

Wiring

5.0 SYSTEM START-UP AND REFRIGERANT CHARGING

5.1 System Start-Up Overview

Once the system hardware and wiring has been properly installed, the next step is to start the system up, verify indoor air-flow, and adjust the refrigerant charge. To assure optimum comfort, efficiency, and reliability, it is extremely important to follow the procedures in this section to assure the indoor air-flow and refrigerant charge are correct.

5.2 Initial Power-Up and EcoNet™ Communication Verification

After all installation steps have been completed, apply electrical power to the indoor and outdoor units. The EcoNet™ Control Center or thermostat should be switched to the off position initially. Within 45 seconds of power being applied, the EcoNet™ Control Center should detect the indoor and outdoor units. A "0" for Standby Mode will be displayed on the Variable Speed Outdoor Control (VSODC).

IMPORTANT: It is recommended to wait at least 12 hours after electrical power is applied to the outdoor unit before starting the compressor to assure any liquid refrigerant inside the compressor has been driven out by the compressor stator heat.

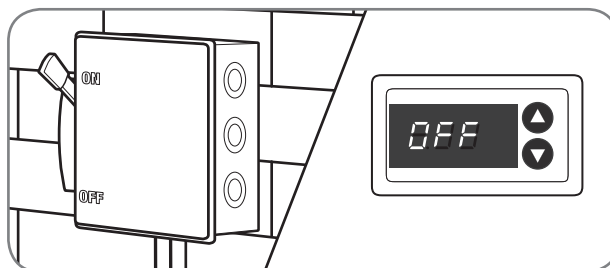

Start-Up

5.3 EcoNet™ Control Center Set-Up

Follow the set-up instructions included with the EcoNet™ Control Center prior to starting system. Cooling dehumidification must be disabled for indoor air-flow verification and refrigerant charging. The indoor air-flow trim adjustment should be set to 0% for indoor air-flow verification, but should be adjusted prior to refrigerant charging should the application require an adjustment to the indoor air-flow.

5.0 SYSTEM START-UP AND REFRIGERANT CHARGING

5.4 Initial System Start-Up

Using the EcoNet™ Control Center service menu (See Section 5.5 below) or using the thermostat (See Section 5.6 below), put the system into the charging mode which will force it to operate at 100% capacity and indoor air-flow which is necessary for accurate indoor air-flow verification and refrigerant charging. Check to make sure "On-Demand Dehumidification" is turned off in the EcoNet™ Control Center (or on the air-handler or gas furnace control board for conventional 24VAC control applications).

5.5 Entering Charge Mode Using EcoNet™ Control Center Service Menu

1. Set the "Mode" to the "OFF" position.
2. Select "SERVICE" on the EcoNet™ Control Center screen.
3. Select "ODU Checkout". If the next screen displays a flashing "Lock-Out" message, there will be up to a 5 minute delay before it is possible to continue.
4. Once the flashing lock-out message disappears, touch OFF on the screen displayed to the right of "Var Speed ODU Test".
5. Touch the "UP" arrow repeatedly until the "Heat Charge" or "Cool Charge" menu item is displayed depending on which mode the system is to be charged in.
6. Touch "Start Test".
7. System will now operate at 100% of capacity and indoor air-flow to allow proper indoor air-flow verification and refrigerant charging until the Charge Mode is manually ended. There may be a delay before the system actually starts. If the system doesn't start, cycle power to both the indoor and outdoor units and repeat steps 1-6.
8. **Note:** When charging in the heating mode, the system will initiate a defrost cycle every 34 minutes if the coil temperature is below 35°F [1.7°C] to assure the coil stays frost free during the charging process. Allow the system to complete the defrost cycle and stabilize for at least 10 minutes before attempting to evaluate the charge level.
9. To end Charge Mode, touch the "UP" arrow repeatedly until "OFF" is displayed on the screen and then touch "Stop Test". Then touch the left arrow on the screen to return to the main screen.

10. If the indoor blower continues to run continuously after exiting the Charge Mode, cycle the power to the air-handler or furnace.

5.6 Entering Charge Mode When Using a Conventional 24VAC Thermostat

1. Set the thermostat to the cool or heat mode depending on which mode the system is to be charged in.
2. Adjust the set point several degrees below (cool mode) or above (heat mode) the room temperature to assure the thermostat is calling for operation and will continue to do so throughout the charging process.
3. When the charging process is complete, adjust the temperature set-point to the desired level.

5.0 SYSTEM START-UP AND REFRIGERANT CHARGING

5.7 Indoor Air-Flow Verification

Correct indoor air-flow and proper supply air distribution is critical to system comfort, efficiency and reliability. Excessive indoor air-flow results in elevated humidity levels in the cooling mode and excessive air noise. Low indoor air-flow reduces system capacity and can result in coil icing and compressor failure in the cooling mode and can cause nuisance high pressure switch tripping and increases power consumption in the heating mode.

Fortunately, when the (-)P20 heat pumps are matched to the correct air-handler or furnace/coil combination and are controlled by the communication EcoNet™ Control Center, the indoor air-flow is automatically controlled to the proper level based on the model data stored in the VSODC memory card. When the indoor blower is operating, the EcoNet™ Control Center

will display the indoor CFM in the Service Menu of the control. The approximate CFM is also displayed in 100 CFM increments by a flashing LED on the air-handler or furnace control board while the blower is operating (one flash per 100 CFM) for installations where a conventional 24VAC thermostat is used.

Once the system is operating in the Charging Mode, confirm the indoor CFM is close to those values in the table below. If the displayed CFM is not reasonable close to the value in the table, confirm cooling dehumidification is disabled, the indoor air-flow trim adjustment is set to 0%, and verify the model numbers of the indoor and outdoor units are an approved combination by the manufacturer. Once the indoor air-flow is verified, the indoor air-flow trim adjustment may be changed to suit the installation and should be done prior to final charge adjustment.

NOTICE: AHRI rated CFM may differ slightly from values in the table below.

Outdoor Unit Model No.	Displayed Indoor CFM Cooling Mode	Displayed Indoor CFM Heating Mode
(-)P2024B	800	800
(-)P2036B	1200	1300
(-)P2048B	1600	1500
(-)P2060B	1700	1800

5.8 Refrigerant Charging

The refrigerant charge for all systems should be checked against the Charging Chart located inside the access panel cover.

⚠WARNING: The top of the scroll compressor shell is hot. Touching the compressor top may result in serious personal injury.

⚠CAUTION: R-410A pressures are approximately 60% higher (1.6 times) than R-22 pressures. Use appropriate care when using this refrigerant. Failure to exercise care may result in equipment damage or personal injury.

Charge for all systems should be checked against the Charging Chart inside the access panel cover.

IMPORTANT: Do not operate the compressor without charge in the system.

Addition of R-410A will raise high-side pressures (liquid and discharge).

NOTICE: System maintenance is to be performed by a qualified and certified technician.

The optimum refrigerant charge for any outdoor unit matched with an indoor coil/air handler is affected by the application. Therefore, charging data has been developed to assist the field technician in optimizing the charge for all mounting configurations (UF – Upflow, DF – Downflow, LH – Left-Hand Discharge, and RH – Right-Hand Discharge). Refer to the charging chart inside the access panel cover on the unit and choose the appropriate column for the specific application being installed or serviced. New installations utilizing either an RCF indoor coil installed on a gas furnace or an RHMV series air handler in the downflow or horizontal right-hand discharge may require removal of some refrigerant since the factory charge could result in an overcharge condition for short line length applications.

The following method is used for charging systems in the cooling and heating mode. All steps listed should be performed to ensure proper charge has been set. For measuring pressures, the service valve port on the liquid valve (small valve) and the true service port located between the two service valves are to be used.

5.0 SYSTEM START-UP AND REFRIGERANT CHARGING

5.8.1 Measurement Device Set-Up

1. With an R-410A gauge set, attach the high-pressure hose to the access fitting on the liquid line (small) service valve at the OD unit.
2. Attach the low-pressure hose to the exterior suction port located between the two service valves that is connected to the suction tube between the reversing valve and compressor.
3. Attach a temperature probe within 6" [15.2 cm] of the outside of the unit on the copper liquid line (small line). For more accurate measurements, clean the copper line prior to measurement and use a calibrated clamp-on temperature probe or an insulated surface thermocouple.

5.8.2 Preliminary Charging by Weight

NOTICE: Adjust the system charge by weight for the linear length of the refrigerant line set.

For a new installation, evacuation of inter-connecting tubing and indoor coil is adequate; otherwise, evacuate the entire system. Use the factory charge shown in "Electrical and Physical Data" in Section 3.2 of these instructions or on the unit data plate. Note that the charge value includes charge required for 15 ft. [4.6 m] of standard-size liquid line without a filter drier.

Calculate actual charge required with the actual installed liquid line size and length using:

1/4" [6.4 mm] O.D. = .3 oz./ft. [28.3 g/m]

5/16" [7.9 mm] O.D. = .4 oz./ft. [37.7 g/m]

3/8" [9.5 mm] O.D. = .6 oz./ft. [56.7 g/m]

1/2" [12.7 mm] O.D. = 1.2 oz./ft. [113.3 g/m]

Add 6 oz. for field-installed filter drier.

Charge Adjustment = (Line Set (oz./ft.) x Total Length) – Factory Charge for Line Set

Example: A three ton heat pump unit with factory installed 3/8" liquid service valve requires 75 ft. of line set with a liquid line diameter of 1/2".

Factory Charge for Line Set = 15 ft. x .6 oz. = 9 oz.

Charge Adjustment = (1.2 oz. x 75 ft.) – 9 oz. = + 81 oz.

With an accurate scale (+/- 1 oz. [28.3 g]) or volumetric charging device, adjust the refrigerant charge based on the actual line set length. If the entire system has been evacuated, add the total calculated charge.

IMPORTANT: Charging by weight is not always accurate since the application can affect the optimum refrigerant charge. Charging by weight is considered a starting point ONLY. Always check the charge by using the Charging Chart

and adjust as necessary. CHARGING BY LIQUID SUBCOOLING PER THE SYSTEM CHARGING CHART MUST BE USED FOR FINAL CHARGE ADJUSTMENT.

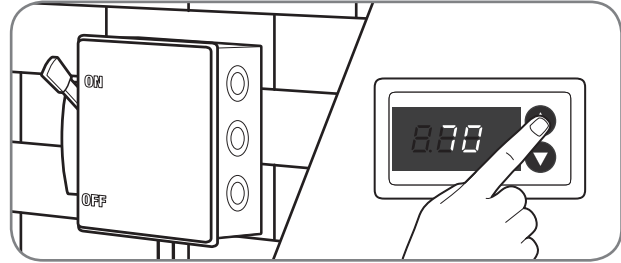

IMPORTANT: R-410A is a blended refrigerant of R-32 and R-125 (50/50). These two refrigerants have different saturation curves and therefore change state at different pressures and temperatures. If charge is added to the system in the vapor state, it is possible to have a disproportionate amount of each part of the R-410A blend which will cause unstable and inefficient operation. Therefore, it is critical to add R-410A in the liquid form only!

5.8.3 Preliminary Charging by Pressures (Optional)

1. Following airflow verification and charge weigh-in, run the unit for a minimum of 15 minutes prior to noting pressures and temperatures.

IMPORTANT: Indoor conditions as measured at the indoor coil must be within 2°F [1.1°C] of comfort conditions per the homeowner's preference.

NOTICE: If the indoor temperature is above or below this range, run the system to bring the temperature down or run the electric heat/furnace to bring the temperature up to within this range.

2. Note the Outdoor Dry Bulb Temperature, ODDB° = _____°F [_____]°C. Unit charging is recommended under the following outdoor conditions ONLY:

Cooling Mode ONLY: 55°F [12.8°C] outdoor dry bulb and above

Heating Mode ONLY: Between 40°F [4.4°C] and 60°F [15.6°C] outdoor dry bulb

3. Locate and note the design pressures. The correct liquid and vapor pressures are found at the intersection of the installed system and the outdoor ambient temperature on the Charging Chart located inside the access panel cover.

Liquid Pressure: = _____psig; Vapor Pressure = _____psig

5.0 SYSTEM START-UP AND REFRIGERANT CHARGING

NOTICE: The refrigerant pressures provided are for preliminary charge check ONLY. These pressure values are typical, but may vary due to application. Evaporator load (indoor coil in cooling mode/outdoor coil in heating mode) will cause pressures to deviate. The values listed are for the correct matched indoor coil ONLY!

- If the measured liquid pressure is below the listed requirement for the given outdoor and indoor conditions, add charge. If the measured liquid pressure is above the listed requirement for the given outdoor and indoor conditions, remove charge.

5.8.4 Final Charging by Liquid Subcooling

- After preliminary charging by weight or pressures, find the design subcooling value. The correct subcooling value is found at the intersection of the installed system and the outdoor ambient temperature on the Charging Chart located inside the access panel cover.
 SC° from Charging Chart = _____ $^{\circ}$ F [_____ $^{\circ}$ C].

IMPORTANT: Indoor conditions as measured at the indoor coil are required to be within 2 $^{\circ}$ F (1.1 $^{\circ}$ C) of comfort conditions as preferred by the homeowner and must have operated for at least 15 minutes prior to final charge adjustment. Unit charging is recommended under the following outdoor conditions ONLY:

Cooling Mode: 55 $^{\circ}$ F [12.8 $^{\circ}$ C] outdoor dry bulb and above

Heating Mode: Between 40 $^{\circ}$ F [4.4 $^{\circ}$ C] and 60 $^{\circ}$ F [15.6 $^{\circ}$ C] outdoor dry bulb

NOTICE: Systems should not be charged below 40 $^{\circ}$ F [4.4 $^{\circ}$ C] outdoor temperature.

- NOTICE:** If the indoor temperature is above or below the recommended range, run the system to bring the temperature down or run the electric heat/furnace to bring the temperature up.
- Note the measured Liquid Pressure, Liq Press = _____psig, as measured from the liquid (small) service valve. Use the Temperature Pressure Chart below to note the corresponding saturation temperature for R-410A at the measured liquid pressure.
 Liquid Saturation Temperature, SAT $^{\circ}$ = _____ $^{\circ}$ F [_____ $^{\circ}$ C].
 - Note the liquid line temperature, Liq $^{\circ}$ = _____ $^{\circ}$ F [_____ $^{\circ}$ C], as measured from a temperature probe located within 6" [15.2 cm] outside of the unit on the copper liquid line (small line). It is recommended to use a calibrated clamp-on temperature probe or an insulated surface thermocouple.
 - Subtract the liquid line temperature from the saturation temperature to calculate subcooling.
 SAT° _____ $^{\circ}$ F [_____ $^{\circ}$ C] - Liq $^{\circ}$ _____ $^{\circ}$ F [_____ $^{\circ}$ C] = SC $^{\circ}$ _____ $^{\circ}$ F [_____ $^{\circ}$ C]
 - Adjust charge to obtain the specified subcooling value. If the measured subcooling level is below the listed requirement for the given outdoor temperature, add charge. If the measured subcooling level is above the listed requirement for the given outdoor temperature, remove charge.

5.8.5 R-410A Temperature Pressure Chart

SATURATION TEMP (Deg. F) [Deg. C]	R-410A PSIG	SATURATION TEMP (Deg. F) [Deg. C]	R-410A PSIG	SATURATION TEMP (Deg. F) [Deg. C]	R-410A PSIG	SATURATION TEMP (Deg. F) [Deg. C]	R-410A PSIG
-150 [-101]	-	-30 [-34]	17.9	35 [2]	107.5	100 [38]	317.4
-140 [-96]	-	-25 [-32]	22.0	40 [4]	118.5	105 [41]	340.6
-130 [-90]	-	-20 [-29]	26.4	45 [7]	130.2	110 [43]	365.1
-120 [-84]	-	-15 [-26]	31.3	50 [10]	142.7	115 [46]	390.9
-110 [-79]	-	-10 [-23]	36.5	55 [13]	156.0	120 [49]	418.0
-100 [-73]	-	-5 [-21]	42.2	60 [16]	170.1	125 [52]	446.5
-90 [-68]	-	0 [-18]	48.4	65 [18]	185.1	130 [54]	476.5
-80 [-62]	-	5 [-15]	55.1	70 [21]	201.0	135 [57]	508.0
-70 [-57]	-	10 [-12]	62.4	75 [24]	217.8	140 [60]	541.2
-60 [-51]	0.4	15 [-9]	70.2	80 [27]	235.6	145 [63]	576.0
-50 [-46]	5.1	20 [-7]	78.5	85 [29]	254.5	150 [66]	612.8
-40 [-40]	10.9	25 [-4]	87.5	90 [32]	274.3		
-35 [-37]	14.2	30 [-1]	97.2	95 [35]	295.3		

5.9 Completing Installation

- Disconnect the hoses from the pressure ports. Replace the pressure port caps and tighten adequately to seal caps. **DO NOT overtighten.**
- Replace the service valve top caps finger-tight and then tighten with a wrench to adequately seal caps. **DO NOT overtighten.**
- Replace control box cover and service panel and install screws to secure panels.
- Restore power to unit at disconnect if required.
- Exit Charging Mode and configure EcoNet™ Control Center or thermostat per the thermostat installation instructions and set to desired mode and temperature.

6.0 NORMAL SEQUENCE OF OPERATION

The following sections provide details on how the (-)P20 heat pump systems are designed to operate under normal conditions. Under abnormal conditions, Active Compressor and Inverter Protection features built into the controls may alter how the system operates to protect the compressor and inverter from damage. The sequence of operation is based on the system being set up for EcoNet™ communications using an EcoNet™ enabled air-handler or gas furnace and an EcoNet™ Control Center. A section is provided at the end that describes how the system will operate if a conventional 24VAC 2-stage thermostat is used in emergency situations when communication issues are encountered to allow the system to operate until the communication issues are resolved.

NOTE: The use of a conventional 24VAC thermostat eliminates many of the advanced operating and diagnostic features the customer has paid for and is strongly discouraged except in temporary emergency situations until communication issues are resolved.

6.1 Cooling Mode

The EcoNet™ Control Center will determine when cooling is necessary and the percentage of capacity required and will then communicate this information to the EcoNet™ Variable Speed Outdoor Control (VSODC) which will direct the Power Inverter to ramp the compressor up to the appropriate speed to meet the required capacity percentage being requested. The percentage of capacity required is based on the difference between the temperature set-point and the room temperature measured at the Control Center. One second after the compressor starts, the VSODC will direct the variable speed ECM outdoor motor to operate at the appropriate speed to deliver the necessary outdoor air-flow for that capacity percentage. Upon a call for cooling, the EcoNet™ Control Center accesses the indoor air-flow parameters found in the model data residing in the VSODC memory card and directs the EcoNet™ enabled air-handler or gas furnace control board to deliver an appropriate indoor air-flow level based on the capacity percentage required at that point in time. The EcoNet™ air-handler or gas furnace control board will then direct the variable speed ECM indoor blower motor to start and operate at the requested cooling air-flow level. As the building load changes throughout the call for cooling operation, the compressor speed, outdoor fan speed, and indoor air-flow level will respond by ramping up or down as required to meet the building load exactly rather than simply cycling on and off as conventional systems do. Should the building load exceed the capacity of the system, the inverter will direct

the compressor to speed up and operate at greater than 100% capacity (Overdrive Mode) in an attempt to meet the building load until the maximum compressor speed is reached. Since the noise level of the compressor increases as speed increases, the maximum allowable compressor speed in the Overdrive Mode can be lowered using the EcoNet™ Control Center Installer Menu (RPM Blocking) should the homeowner find the compressor noise objectionable in the Overdrive Mode. When the call for cooling has ended, the EcoNet™ Control Center will direct the outdoor and indoor units to shut down. The compressor and outdoor fan motor will ramp down to zero RPM and the indoor blower motor will ramp down to the minimum air-flow level for 30-45 seconds to extract the residual cooling from the cold indoor coil before it stops.

6.2 On-Demand Cooling Dehumidification

The EcoNet™ Control Center can be configured for On-Demand Dehumidification. This feature allows the system to automatically increase the level of dehumidification in the cooling mode by decreasing the indoor air-flow by 15% when the indoor relative humidity measured at the Control Center rises above the set-point. Once the relative humidity drops to or below the set-point, the indoor air-flow level returns to normal.

6.3 Low Ambient Cooling Mode

Some applications require for space cooling when the outdoor ambient temperature is below normal (<55°F [13°C]) such as a computer room or an interior space with a heat source that must be cooled. (-)P20 heat pumps are equipped with a special low ambient cooling mode that allows the system to provide cooling when the outdoor temperature is below 55°F [13°C] by cycling the outdoor fan to maintain an adequate condensing temperature and subcooling level based on an input from the coil temperature thermistor.

6.4 Heating Mode

The EcoNet™ Control Center will determine when heating is necessary and the percentage of capacity required and will then communicate this information to the EcoNet™ Variable Speed Outdoor Control (VSODC) which will direct the Power Inverter to ramp the compressor up to the appropriate speed to meet the required capacity percentage being requested. The percentage of capacity required is based on the difference

6.0 NORMAL SEQUENCE OF OPERATION

between the temperature set-point and the room temperature measured at the Control Center. One second after the compressor starts, the VSODC will direct the variable speed ECM outdoor motor to operate at the appropriate speed to deliver the necessary outdoor air-flow for that capacity percentage. Upon a call for heating, the EcoNet™ Control Center accesses the indoor air-flow parameters found in the model data residing in the VSODC memory card and directs the EcoNet™ enabled air-handler or gas furnace control board to deliver an appropriate indoor air-flow level based on the capacity percentage required at that point in time. The EcoNet™ air-handler or gas furnace control board will then direct the variable speed ECM indoor blower motor to start and operate at the requested heating air-flow level. As the building load changes throughout the call for heating operation, the compressor speed, outdoor fan speed, and indoor air-flow level will respond by ramping up or down as required to meet the building load exactly rather than simply cycling on and off as conventional systems do. Since the noise level of the compressor increases as speed increases, the maximum allowable compressor speed in the Overdrive Mode can be lowered using the EcoNet™ Control Center Installer Menu (RPM Blocking) should the homeowner find the compressor noise objectionable in the Overdrive Mode. The current compressor RPM can also be viewed in the EcoNet™ Control Center Service Menu. When the call for heating has ended, the EcoNet™ Control Center will direct the outdoor and indoor units to shut down. The compressor and outdoor fan motor will ramp down to zero RPM and the indoor blower motor will ramp down to the minimum air-flow level for 30-45 seconds to extract the residual heating from the cold indoor coil before it stops.

6.5 Supplemental Electric Heat in Heating Mode

If the building load should exceed the heating capacity in extreme outdoor conditions, the EcoNet™ Control Center will direct the RHMV air-handler to energize supplemental electric heat as required to meet the building load. The indoor air-flow will be forced to operate at the maximum level for the system. For 13kW heaters and higher, the supplemental electric heat will be energized in two stages as required. The compressor and outdoor fan will continue to operate at maximum capacity while supplemental electric heat is energized.

6.6 Dual Fuel Applications – Heating Mode

If the building load should exceed the heat pump heating capacity in extreme outdoor conditions, the EcoNet™ Control Center will direct the outdoor unit to shut down and heating responsibility will be transferred to the gas furnace. An outdoor ambient temperature can be set in the EcoNet™ Control Center to direct the system to automatically switch to gas heat when the outdoor ambient temperature drops below that set-point. If the EcoNet™ Control Center is set to the EMERGENCY HEAT (Furnace Only) mode, heating responsibility will be transferred to the gas furnace.

6.7 Demand Defrost

Defrosting of the outdoor coil in the heating mode is controlled by the Variable Speed Outdoor Control (VSODC). (-)P20 heat pumps utilizes “demand defrost” that initiates a defrost cycle only when frosting is detected on the outdoor coil during heating operation. The VSODC continuously monitors the Outdoor Ambient Temperature Thermistor (OAT) and Outdoor Coil Temperature Thermistor (EVAPIN) to determine when a defrost cycle is required. The following sequence is followed for defrost cycles.

- **Defrost Initiation:** A defrost cycle is initiated when the following conditions are met.
 1. The outdoor coil temperature is below 35°F [1.7°C].
 2. The compressor has operated for at least 34 minutes with the outdoor coil temperature below 35°F [1.7°C].
 3. The VSODC determines a defrost cycle is required based on the OAT and EVAPIN temperatures.

If the above conditions are met, the following action will be taken.

1. The compressor speed is ramped to the predetermined reversing valve switching speed for 30 seconds before the reversing valve is de-energized.
2. The reversing valve is de-energized which will cause it to shift to the cooling position.
3. The outdoor EXV is driven to the 100% open position.
4. The outdoor fan motor is de-energized.

6.0 NORMAL SEQUENCE OF OPERATION

5. The indoor air-handler or gas furnace is directed to supply supplemental heat to prevent cold air from being discharged from the supply registers during the defrost cycle.
 6. The compressor speed is ramped to the pre-determined defrost speed for the duration of the defrost cycle.
- **Defrost Termination:** The defrost cycle will continue until the coil temperature has reached the termination temperature or 14 minutes have elapsed, whichever comes first. The factory default termination temperature is 60°F [15.6°C], although this temperature can be changed to 40°F [4.4°C], 50°F [10°C], or 70°F [21.1°C] using dip switches on the VSODC (see chart below for dip switch settings). When the coil temperature reaches the termination temperature or 14 minutes have elapsed, the following action is taken.
 1. The compressor speed is ramped to the reversing valve switching speed for 30 seconds before the reversing valve is energized.
 2. The reversing valve will be energized, switching it back to the heating position.
 3. The outdoor fan motor is energized.
 4. Auxiliary heat is de-energized.
 5. The EXV will return to the normal superheat control mode.
 6. The compressor speed will ramp to a pre-determined oil circulation speed for 6 minutes.
 7. The system returns to normal heating operation as directed by the EcoNet™ Control Center.

NOTE: Should the outdoor ambient temperature thermistor fail, the VSODC will initiate a defrost every 34 minutes of operation when the coil temperature is below 35°F.

Defrost Termination DIP Switch Settings		
Switch 1	Switch 2	Coil Temperature at Defrost Termination
Off	Off	60°F [15.6°C]
On	Off	50°F [10°C]
Off	On	40°F [4.4°C]
On	On	70°F [21.1°C]

6.8 Sequence of Operation for Conventional 24VAC Thermostat Controls

When the (-)P20**B heat pump system is controlled by a conventional 24VAC 2-stage thermostat rather than the EcoNet™ Control Center, the system will operate as follows:

- The system will operate as a single-stage system instead of a variable speed system.
- When a call for cooling or heating is received from the thermostat, the compressor will start and operate at the nominal capacity level and the (-)HMV air-handler will deliver the nominal air-flow level. For dual fuel applications, an (-)802V, (-)96V, (-)97V, or (-)98V variable speed gas furnace will deliver 100% of the cooling air-flow level selected by dip switches on the furnace control board. Y1 & Y2 must be jumpered at the furnace control board.
- When the call for operation ends, the system will shut down and remain in stand-by mode until another call for operation occurs.
- Demand defrost and low-ambient cooling function normally.

7.0 COMPONENTS & CONTROLS

7.1 Accumulator

All (-)P20 heat pumps are equipped with an accumulator for the purpose of managing possible refrigerant flood back issues that may occur at abnormal environmental conditions.

7.2 Choke/Inductor

The power inverter used in each (-)P20 model has a matching choke/inductor. The choke is designed as a low pass filter and increase inductance. By doing this the input power can be more efficiently used by the inverter and compressor.

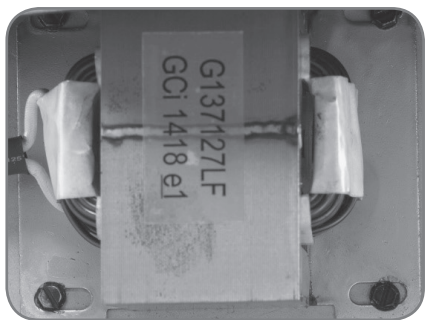

7.3 Coil Temperature Thermistor

(-)P20 heat pumps are equipped with a coil sensor that is used for the purposes of identifying defrost parameters and low ambient cooling operational conditions. This thermistor is provided with the suction line thermistor as a single harness.

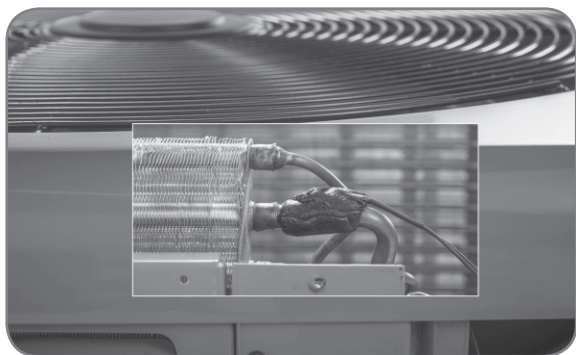

7.4 Compressor

(-)P20 heat pumps are equipped with a Copeland variable speed scroll compressor with a brushless Permanent Magnet motor. The compressor is designed to work in conjunction with the Power Inverter Compressor Control and the Variable Speed Outdoor Control to provide capacity modulation.

7.5 Discharge Line Thermistor

(-)P20 heat pumps are equipped with a discharge line thermistor that is used to measure the compressor discharge temperature. This sensor's leads connect directly to the inverter which communicates with the Variable Speed Outdoor Control (VSODC). The compressor discharge temperature is continuously monitored by the controls. The compressor speed is reduced as needed to prevent excessive discharge temperatures that would damage the compressor under extreme environmental conditions. As the discharge temperature returns to an acceptable level, the controls will gradually increase the compressor speed in an attempt to meet the capacity demand as long as the discharge temperature remains at a safe level.

7.0 COMPONENTS & CONTROLS

7.6 EcoNet™ Variable Speed Outdoor Control (VSODC)

7.6.1 Board Features and Connections

(-)P20 heat pumps are equipped with a Variable Speed Outdoor Control (VSODC) that interfaces with the inverter, EcoNet™ Control Center, and EcoNet™ enabled air-handler or gas furnace using the EcoNet™ serial communication protocol. The VSODC provides a low voltage terminal block for control wiring and connections for various sensors, controls, outdoor fan motor and inverter. It also has a dual 7-segment LED for displaying status and fault codes. Buttons are provided for navigating the control menu and to initiate and terminate various test modes. A plug-in memory card provides model specific information (model data) necessary for proper unit operation and parameters for the correct indoor air-flow. Dip switches are provided to allow adjustment of the defrost termination temperature, outdoor superheat setting, and number of EXV steps. Colored LED's are provided to indicate if the EXV is in the process of opening or closing.

The following is a list of features on the VSODC and location of each.

1. Thermostat Terminals
2. Communication wire terminals
3. Modbus unitary inverter communication connection

4. Outdoor PSC Fan relay connections
5. Outdoor ambient thermistor connection
6. Coil sensor (EVAPIN) and suction thermistor (OST) connections
7. Liquid line thermistor (OLT) connection
8. Outdoor ECM fan PWM output connection
9. Suction pressure transducer (SPT) connection
10. Liquid pressure transducer (LPT) connection
11. Electronic expansion valve connection
12. Reversing Valve Connections
13. 3 Amp fuse
14. Test and SW2 Button
15. Communications LEDs (ET – EcoNet™ communication is transmitting; RT – EcoNet™ communication is receiving)
16. Memory card connection
17. Dual seven segment LED – Displays status, diagnostic codes, fault recall, compressor speed, superheat, and defrost menus
18. Dip Switches – Defrost Termination Temperature (DF1, DF2)
19. Dip Switches – EXV SH Offset (SH1, SH2)
20. EXV Operational Lights (Green – EXV is opening; Amber - EXV is closing)

CAUTION: UNIT MAY START SUDDENLY AND WITHOUT WARNING.

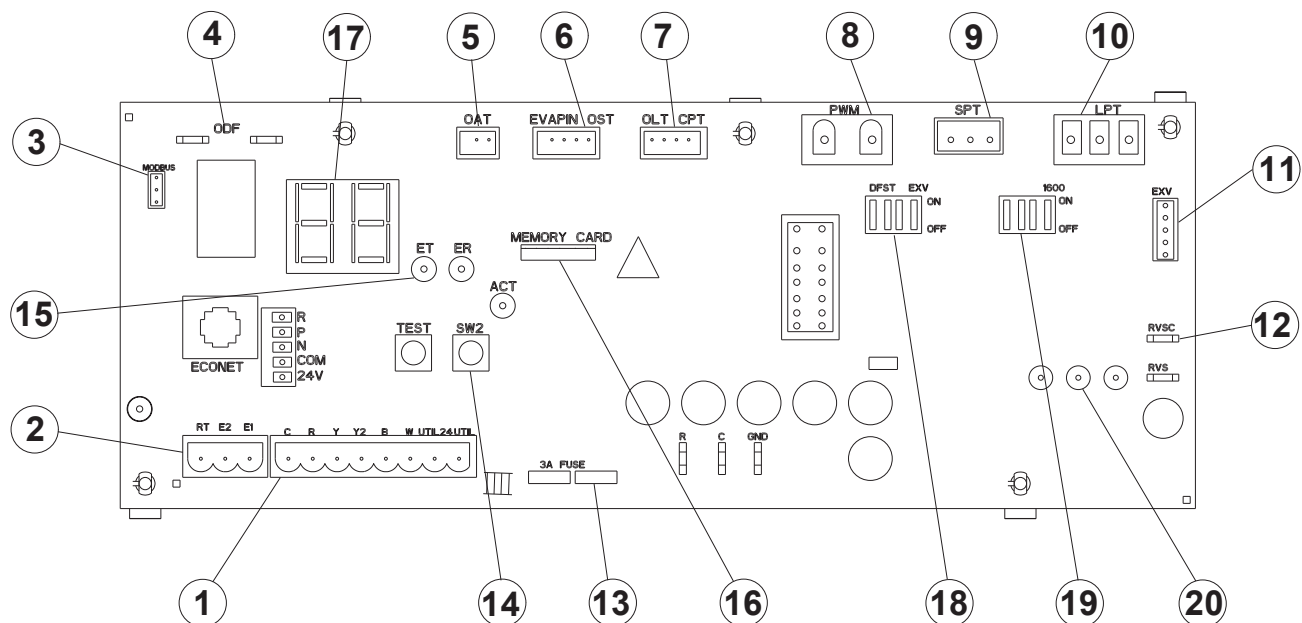

7.0 COMPONENTS & CONTROLS



7.6 EcoNet™ Variable Speed Outdoor Control (VSODC) (cont.)

7.6.2 TEST and SW2 Buttons

TEST and SW2 buttons are used to enter the following menus and modes:

- Test mode
- Forced Defrost
- Fault Code Recall Menu
- Compressor Speed Menu
- Superheat Menu

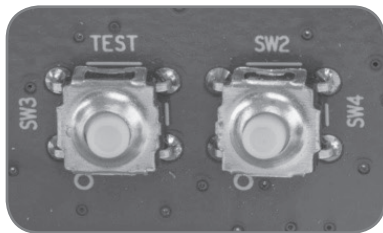

7.6.3 Memory Card

- The memory card stores all unit information.
- The unit information is called model data.
- The model data is all the information needed for proper unit operation of that specific model.

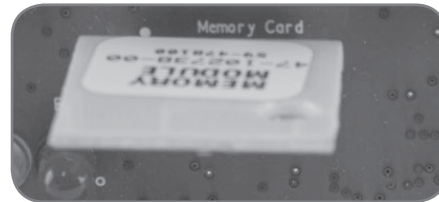

7.6.4 Factory Superheat Setting

The VSODC is pre-programmed with the optimum superheat setting of 6° for each outdoor unit.

7.6.5 Superheat Offset DIP Switch Settings (DIP Switch Bank on the Right)

Although the factory programmed superheat setting is considered to be the most efficient setting for each unit, installation conditions can effect the measurement of superheat on the VSODC. For this

reason the following dip switch settings have been provided to enable flexibility for various installation conditions.

Superheat Offset Selection Profile	Off Set from Programmed Setting (°F)
A	0
B	-4
C	-2
D	+2

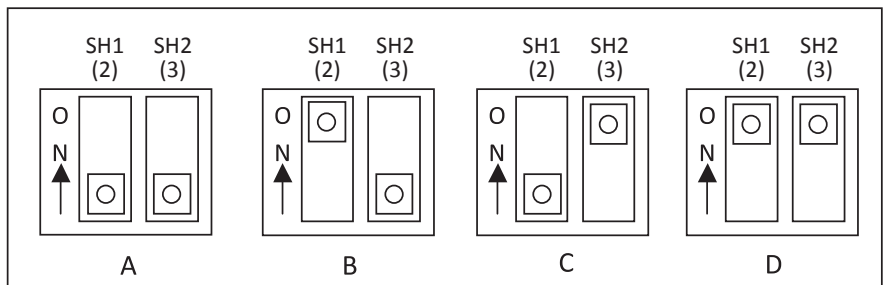

7.6.6 Defrost Termination Temperature DIP Switches (DIP Switch Bank on the Left)

Defrost Termination DIP Switch Settings		
DF1 (Switch 3)	DF2 (Switch 4)	Coil Temperature at Defrost Termination
Off	Off	60°F [15.6°C]
On	Off	50°F [10°C]
Off	On	40°F [4.4°C]
On	On	70°F [21.1°C]

7.0 COMPONENTS & CONTROLS

7.6 EcoNet™ Variable Speed Outdoor Control (VSODC) (cont.)

7.6.7 Menu Structure

The VSODC is equipped with a dual 7-segment LED display and two push buttons (SW2 and TEST). The display and push buttons work together to allow the technician access to fault recall, compressor speed locking, and heating mode superheat measurement.

The following process can be used to access any of these menus:

- Press the SW2 and TEST buttons for 5-8 seconds.
- After this time the dual seven segment LEDs will show the first menu option (FC).
- To enter a menu, depress the SW2 button
- To toggle to the next menu depress the test button.
- No action for 5 seconds in the root menu structure will return the control to normal operation.

Menu Definition:

FC = Fault Codes – by selecting this menu the control will list the stored numerical fault codes in order of sequence by which they were stored. Depressing the SW2 button while a fault code is shown will increment to the next fault. Depressing the TEST button will force the control back to the main menu.

CS = Compressor Speed – For this selection menu to initiate the requested compressor speed, there must be an active call for compressor operation, the compressor must be operating, and the selection must be static for 5 seconds. The Compressor Start and Run, and Compressor Shut down algorithms will be used to obtain the requested compressor speed.

- 3 (MAXIMUM Speed)
- 2 (INTERMEDIATE Speed)
- 1 (MINIMUM Speed)

SH (Superheat Measurement)

- The display is to show the following options:
- HI = Superheat is more than 5°F [2.8°C] above SH_SP
- HI = Superheat is between 1.5°F [0.8°C] and 5°F [2.8°C] above SH_SP
- 00 = Superheat is within ±1.5°F [0.8°C] of SH_SP
- LO = Superheat is between 1.5°F [0.8°C] and 5°F [2.8°C] below SH_SP
- LO = Superheat is 5°F [2.8°C] or more below SH_SP.

IMPORTANT: This mode should be manually exited. If this menu is not exited manually the VSODC will wait 24 hours before returning to normal operation. During this time the VSODC will only request the selected compressor speed.

7.6.8 Replacement of the VSODC

Each control board in the EcoNet™ Communication Network needs information specific to the unit the control is installed in. This information is called model data because it is model specific information required for the communication network to operate properly for the specific model installed. The data for a unit contains information that allows the unit to operate correctly.

When a control board requires replacement, it is important that the replacement board gets the model data from the old control. The primary way the replacement control gets this information is by the memory card that should be installed on the old control. Remove the memory card from the old control, replace the control, and reinstall the memory card on the new control.

NOTE: The control board for RP20** B models is not interchangeable with RP20**A boards. Check part numbers to confirm compatibility.

The memory card from a different unit should never be used.

NOTE: See links to training and service manuals at MyRheem.com or MyRuud.com, or contact the wholesale distributor selling this unit.

7.0 COMPONENTS & CONTROLS

7.7 Electronic Expansion Valve

(-)P20 heat pumps are equipped with electronic expansion valves (EXV). The advantage an EXV is its ability to accurately control refrigerant flow over a much wider capacity range than a conventional mechanical TXV. The Variable Speed Outdoor Control (VSODC) uses inputs from the suction line thermistor and suction pressure transducer to precisely calculate suction superheat and make necessary adjustments to the refrigerant flow through the EXV to maintain the optimum superheat level. The VSODC is programmed to ignore short duration changes in the pressure and temperature inputs which allows more stable operation than conventional TXV's. The EXV utilizes an external 4-pole removable stator for

serviceability. An internal check valve is provided that assures unrestricted flow in the reverse direction when the system is operating in the cooling mode.



7.8 Filter & Ferrite Rings

There are 3 ferrite rings and one filter on all models. The ferrite rings are similar in purpose to the choke, whereas they create an inductive field around the assembled wires, but they do not filter the signals. The ferrite rings are applied only for the purpose of keeping the high voltage lines from cross contaminating one another and thereby creating unexpected operation and electromagnetic

interference. The single filter has been applied to eliminate high frequency "noise" from the incoming power line thereby making it more efficient for the inverter to convert the incoming line voltage single phase AC power into 3 phase DC power.

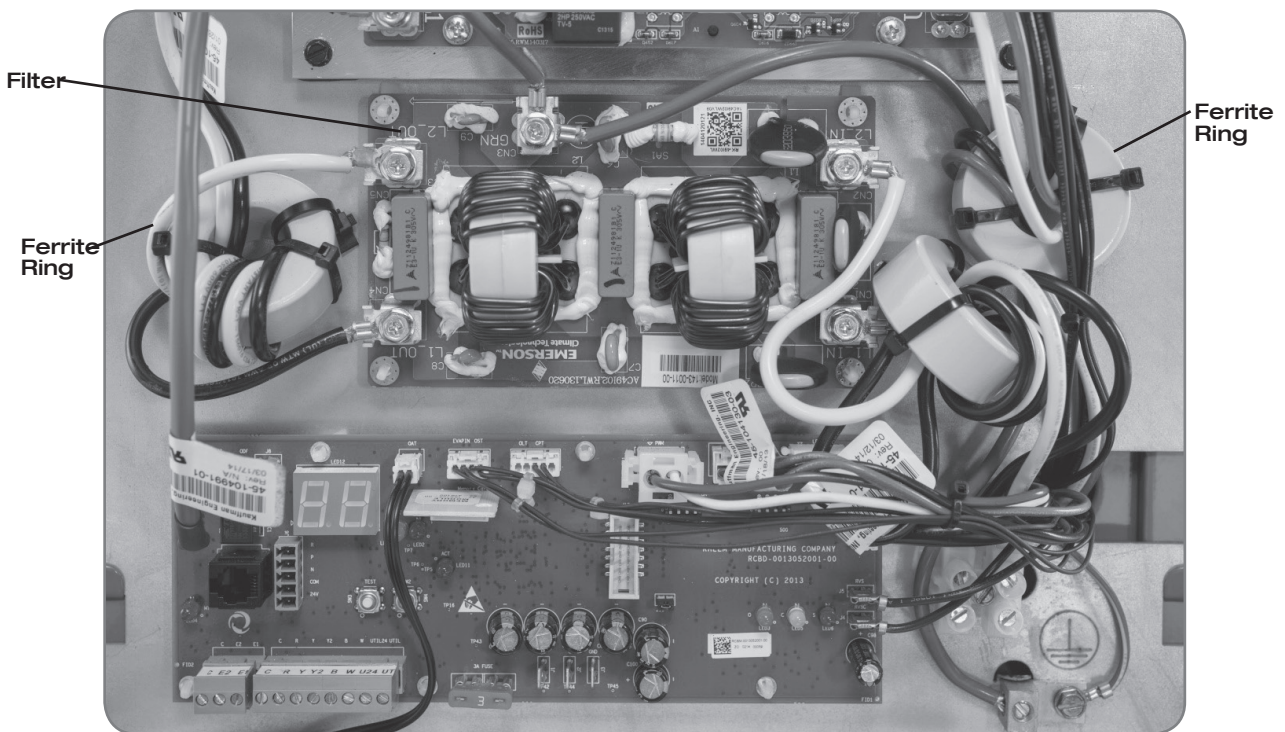

7.0 COMPONENTS & CONTROLS

7.9 High Pressure Control (HPC)

Sensing of the compressor discharge pressure is accomplished by a conventional automatic reset pressure control that is brazed into the compressor discharge line. The HPC leads connect directly to the inverter which communicates with the Variable Speed Outdoor Control (VSODC). The contacts on the high pressure control (HPC) open when the compressor discharge pressure of approximately 610 PSIG [4206 kPa] and automatically close when the pressure drops below approximately 420 PSIG [2896 kPa].

7.10 Liquid Pressure Transducer

(-)P20 heat pumps are equipped with a liquid pressure transducer for the purpose of measuring the liquid pressure at the outdoor unit. The output of this device is a 0.5 – 4.5VDC signal that the VSODC converts to a pressure used for calculating the liquid subcooling level. The VSODC communicates the liquid pressure and subcooling level to the EcoNet™ Control Center where they are displayed on outdoor unit status screen.

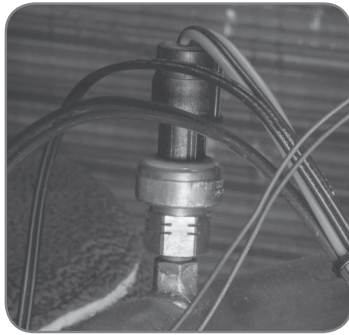

7.11 Liquid Temperature Thermistor

(-)P20**B heat pumps are equipped with a liquid temperature thermistor for the purpose of measuring the liquid line temperature at the outdoor unit. The liquid line temperature is used by the VSODC to calculate the cooling and heating mode liquid subcooling level. The VSODC communicates the liquid line temperature and subcooling level to the EcoNet™ Control Center where they are displayed on outdoor unit status screen.

RP20**B COMPRESSOR OPERATING SPEEDS						
UNIT	COOLING			HEATING		
	LOW	CHARGE MODE	MAX	LOW	CHARGE MODE	MAX
RP2024B	1600	3000	3500	1800	3000	5500
RP2036B	1600	2800	3200	1800	2800	5700
RP2048B	1400	3750	4500	1800	3750	6500
RP2060B	1500	4100	5500	2000	4100	6500

7.12 Outdoor Ambient Temperature Sensor

The outdoor ambient temperature is sensed by a thermistor located directly underneath the control box where it is shielded from direct sunlight. The thermistor leads plug into the connector marked OAT on the Variable Speed Outdoor Control (VSODC). The outdoor ambient temperature is utilized by the VSODC and EcoNet™ Control Center for several control functions and is displayed on the EcoNet™ Control Center.

7.13 Outdoor Fan Motor

(-)P20 heat pumps are equipped with variable speed outdoor fans controlled by a pulse width modulated signal (PWM) from the Variable Speed Outdoor Control. The fan speed is selected to optimize performance based on compressor speed.

7.14 Outdoor Fan Blade

(-)P20 heat pumps are equipped with a swept fan blade design that provides improved efficiency and quieter operation than conventional fan blade designs.

7.15 Power Inverter Compressor Control

(-)P20 heat pumps are equipped with a power inverter that varies the compressor speed to match the changing capacity needs of the conditioned space. The inverter interfaces with the Variable Speed Outdoor Control (VSODC) which communicates the level of system capacity that is required to the inverter based on input from the EcoNet™ Control Center or conventional 24VAC 2-stage thermostat. The inverter converts incoming single phase power to simulated variable frequency 3-phase power that is connected to the 3-phase compressor motor. Each of the four (-) P20 models has a unique inverter specifically designed and qualified for that specific model to provide reliable operation under the most extreme conditions. Each inverter is programmed to monitor compressor power consumption, motor torque, input current, input voltage, compressor discharge pressure, and compressor discharge temperature. When the inverter identifies a condition that could potentially result in compressor or inverter damage, it automatically reduces the compressor speed until a more reliable operating condition is obtained or shuts the compressor completely off if necessary. Once safe operating conditions are attained, the inverter will gradually increase the compressor speed in an attempt to meet the capacity demand

7.0 COMPONENTS & CONTROLS

as long as the operating conditions remain within the safe operating range of the compressor and inverter.

1. High voltage input (L1 – Black; L2 – Yellow)
2. Ground connection
3. Choke Connection
4. High Pressure control connection (HPS) – with automatic reset
5. Discharge line thermistor connection (Sensor)
6. Modbus communication connections (RS485)
7. Compressor connections (W-Black; V-Red; U-Yellow)

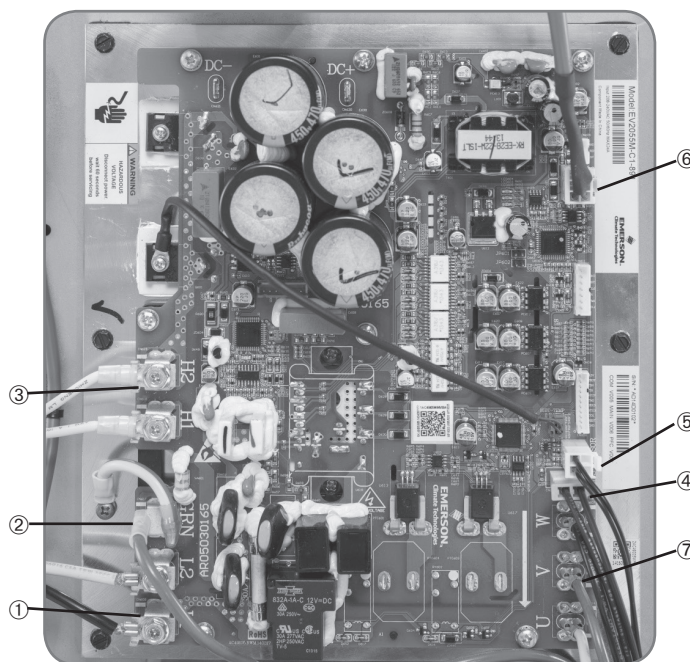

7.16 Suction Pressure Transducer

(-)P20 heat pumps are equipped with a suction pressure transducer for the purpose of measuring the suction pressure between the reversing valve and the accumulator. The output of this device is a 0.5 – 4.5VDC signal that the VSODC converts to a pressure used in calculating the heating mode suction superheat. The measured suction superheat is used for controlling the position of the outdoor EXV to maintain the correct heating mode superheat level. The VSODC communicates the suction pressure and heating mode superheat level to the EcoNet™ Control Center where they are displayed on outdoor unit status screen.

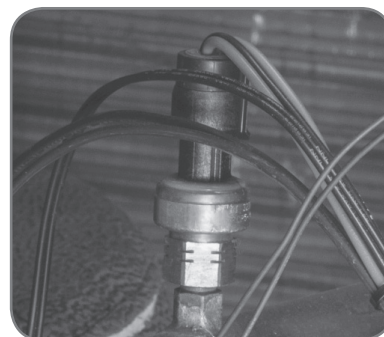

7.17 Suction Temperature Thermistor

(-)P20 heat pumps are equipped with a suction line thermistor for the purposes of measuring suction gas temperature during the heating mode. The measured temperature is paired with the saturated suction temperature and used by the VSODC to calculate superheat and adjust the outdoor EXV to maintain the correct superheat level.

IMPORTANT: The clamp on the suction line thermistor securely attaches to the tube between the outdoor coil and reversing valve. The thermistor must be located between the 10 and 2 o'clock position with a corrosion resistant stainless steel clip. Insulation is factory installed over the suction line thermistor and suction line. This thermistor is provided with the coil thermistor as a single harness.

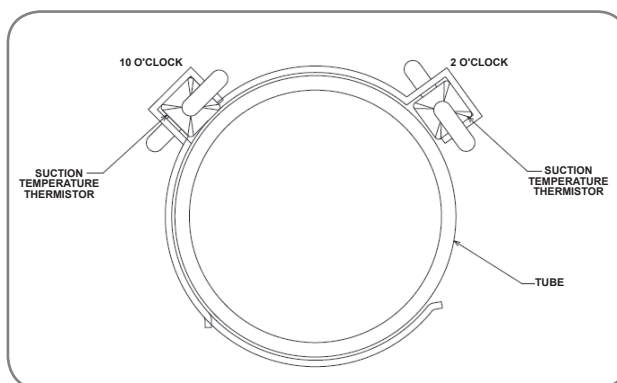

8.0 ACTIVE SYSTEM PROTECTION FEATURES

The controls found in the (-)P20 heat pumps are designed to prevent the system from operating in under conditions that could be harmful to the compressor and inverter. The Variable Speed Outdoor Control (VSODC) and Power Inverter continuously monitor multiple sensors, current, and voltage and will modify the compressor speed or completely shut the system down to protect the compressor and/or inverter if harmful operating conditions are sensed. This process is called Active System Protection. Sections 8.1 – 8.14 give a brief description of the different forms of protection that are provided. Refer to Section 9.5 in the Diagnostic and Troubleshooting Section of this manual for Active System Protection fault codes and additional details for each fault.

8.1 Minimum Run Timer

A minimum run time of 30 seconds is maintained by the VSODC to minimize short cycling which can be harmful to the compressor.

8.2 Oil Return Cycle

When the system has been operating at significantly reduced capacity for an extended period of time, the Variable Speed Outdoor Control (VSODC) will signal the Inverter to speed the compressor up to 100% capacity to help bring any oil that has accumulated in the indoor coil and refrigerant lines back to the compressor sump.

8.3 Off-Cycle Refrigerant Migration – Stator Heat

Refrigerant can migrate to a cold compressor during the off cycle which can dilute the oil or result in the oil being pumped out when the compressor starts. When needed, the VSODC will signal the inverter to energize one of the compressor stator windings (Stator Heat) to generate enough heat to warm the compressor to prevent refrigerant migration to the compressor or boil off any refrigerant that may have migrated to the compressor.

8.4 High Discharge Temperature

The Power Inverter continuously monitors the Discharge Line Thermistor input to protect the compressor should the discharge temperature reach an unsafe level. If the discharge line temperature rises to 235°F [113°C], the Inverter will reduce the compressor RPM incrementally until the temperature drops to 200°F [93°C]. After the discharge temperature reaches 200°F [93°C],

the Inverter will gradually increase the compressor RPM until the compressor returns to normal speed based on the capacity demand. Should the discharge temperature rise to 235°F [113°C] again, the Inverter to repeat the speed reduction cycle to maintain a temperature below 235°F [113°C].

8.5 High Discharge Pressure

The High Pressure Control (HPC) limits the compressor discharge pressure to a safe level to prevent damage to the compressor. When the HPC contacts open at 610 PSIG [4206 kPa], the compressor will proceed to shut down and restart per the sequence shown below. If the HPC contacts open three (3) times during the same call for operation, the VSODC will lock the compressor out and will flash a 29L fault code and the EcoNet™ Control Center will display a High Refrigerant Pressure Lockout fault on the screen. A manual reset is required for the VSODC to exit the compressor lock-out mode and clear the fault. This is accomplished by disconnecting the electrical power to **both** the indoor and outdoor units for 1 minute and then reconnecting power.

NOTE: If the system experiences a high refrigerant pressure lock-out, the system should be evaluated to determine the cause for the high pressure condition and corrective action taken to eliminate the cause. Possible causes include excessive refrigerant charge, a failed indoor blower motor, dirty return air filter, or a dirty indoor coil (heating mode) or excessive refrigerant charge, a failed outdoor motor, or dirty outdoor coil (cooling mode).

8.6 Low Suction Pressure/ Loss of Charge

The Variable Speed Outdoor Control (VSODC) continuously monitors the Suction Pressure Transducer input and will protect the compressor from damage by shutting it down when the suction pressure drops below 50 PSIG [345 kPa] in the cooling mode and below 15 PSIG [103 kPa] in the heating mode. A low pressure condition can result from inadequate indoor air-flow, low refrigerant charge, failed EXV, or a restriction in the refrigerant circuit. The VSODC will allow the compressor to restart if the suction pressure rises to 95 PSIG [655 kPa] in the cooling mode and 40 PSIG [276 kPa] in the heating mode. A low refrigerant pressure fault will be ignored for the first 90 seconds of compressor operation and during the entire defrost cycle to eliminate nuisance faults.

8.0 ACTIVE SYSTEM PROTECTION FEATURES

If there are 3 low pressure faults in the same call for cooling or during 120 minutes of continuous heating operation, the VSODC will lock the compressor out and flash a 21L fault code and the EcoNet™ Control Center will display a Low Refrigerant Pressure Lockout fault on the screen. If the outdoor ambient is below -10°F [-23°C] in the heating mode when the lockout occurs, the control will automatically reset when the outdoor ambient rises to -10°F [-23°C]. If the outdoor ambient is above -10°F [-23°C], a manual reset is required for the VSODU to exit the compressor lock-out mode and clear the fault. This is accomplished by disconnecting the electrical power to **both** the indoor and outdoor units for 1 minute and then reconnecting power.

NOTE: If the system experiences a low refrigerant pressure lock-out, the system should be evaluated to determine the cause for the low pressure condition and corrective action taken to eliminate the cause. Possible causes include low refrigerant charge, failed indoor blower motor, dirty return air filter, or a dirty indoor coil in the cooling mode or low refrigerant charge, a failed outdoor motor, or a dirty outdoor coil in the heating mode.

8.7 Compressor Shut-Down Sequence for High or Low Refrigerant Pressure Fault

1. The compressor is commanded to operate at zero (0) RPM for a minimum of 5 minutes.
2. The outdoor EXV will be directed to completely close for a period of 5 minutes and will then open up completely.
3. The outdoor fan motor will continue to operate during the 5 minute compressor off delay.
4. The VSODC and EcoNet™ Control Center will display the applicable fault code.
5. If after 5 minutes cooling or heating demand persists and the pressure has reached reset conditions, normal system operation will resume and the fault codes will be cleared from the VSODC and EcoNet™ Control Center displays.
6. If after 5 minutes cooling or heating demand persists and the pressure has not reached reset conditions, the outdoor fan motor will be shut down. Once the pressure reaches reset conditions after the 5 minute delay, normal system operation will resume.

8.8 Overcurrent and Current Imbalance

If the compressor current exceeds an acceptable level for the compressor or inverter, the inverter will reduce the compressor speed to allow the current to return to an acceptable level. If there is a current imbalance between the compressor 3-phase windings, the inverter will shut the compressor down for 5 minutes and will lock the compressor out if there are 3 faults within a single call for operation.

8.9 Compressor Operation Outside Envelope

If the inverter detects that the compressor motor torque exceeds an acceptable level for the compressor, the inverter will reduce the compressor speed to keep the torque at an acceptable level.

8.10 Over and Under Voltage

If the supply voltage or internal DC voltage is not within an acceptable operating range, the inverter will shut the compressor off until the voltage returns to an acceptable level.

8.11 Inverter Over Temperature

If the internal inverter temperature sensors detect excessive temperatures within the inverter, the inverter will reduce the speed of the compressor or shut the compressor down until the temperatures drop to an acceptable level. The compressor will be locked out if there are 3 faults within a single call for operation.

8.12 Controls and Communication Malfunction

If the controls senses a malfunction within the control system or communications or if system model data is not available, the controls will act to shut the system down to prevent the system from operating at a condition that could harm components.

8.0 ACTIVE SYSTEM PROTECTION FEATURES

8.13 Sensor Failure Default Operation

If the controls sense an externally connected sensor has failed, the system will enter a fail safe operating mode and will continue to condition the space until the sensor can be replaced. A fault code will be

displayed on the EcoNet™ Control Center and Variable Speed Outdoor Control identifying which sensor has failed. See the table below for the default operation for a sensor failure.

FAILED COMPONENT	FUNCTION	DEFAULT OPERATION
Outdoor Sensor (OAT)	Low Ambient Cooling	No Low Ambient function
	Defrost	Defrost will be initiated based on coil temperature and time
	One minute fan off delay on COOL mode	No delay functions if failure is open or short. Continue function for a thermistor range error.
	PWM Shift above 104°F [40°C]	Shift will not occur
Coil Sensor (EVAPIN)	Defrost Initiate and Terminate	Defrost will occur at each time interval, but will terminate after 5 minutes
	Low Ambient Cooling	No function
Suction Sensor (OST)	EXV Operation	The EXV will be held in the last stored position
EXV Inlet Sensor (LIQ)	Charge Verification	No Charge Verification function
	Sub-cooling verification	No Sub-Cooling verification function

8.14 Exiting Active Protection Lock-Out Mode

Exiting an Active Protection Lock-Out mode can be accomplished by disconnecting electrical power to both the indoor and outdoor units for 1 minute and then restoring power. Keep in mind there was a reason for the lock-out, so the fault code on

the Variable Speed Outdoor Control (VSODC) or EcoNet™ Control Center should be read to assist with diagnosing the root cause of the lock-out and corrective action should be taken to prevent the system from repeating the lock-out.

9.0 DIAGNOSTICS & TROUBLESHOOTING

Advanced operating status and diagnostic information is available through the Variable Speed Outdoor Control dual 7-segment display and the EcoNet™ Control Center that greatly enhances the ability to quickly and accurately diagnose system faults. The following sections provide details for the fault codes plus additional troubleshooting information to assist the service technician.

9.1 Fault Recall Procedure

Fault codes can be recalled using the EcoNet™ Control Center service menu or by using the Variable Speed Outdoor Control (VSODC) menu. The EcoNet™ Control Center service menu is by far the best method as it provides additional fault codes and greater detail that can be used when diagnosing the system.

To access the EcoNet™ Control Center service menu, select SERVICE on the screen and navigate to the fault code section to retrieve any fault codes that have been stored.

To access fault codes on the VSODC, press the SW2 and TEST buttons at the same time for at least 8 seconds and release. FC (Fault Codes) will be displayed on the dual 7-segment display as the first menu item. Press the SW2 button to display the first fault code that was stored. Continue pressing the SW2 button to retrieve additional fault codes in the order they were stored. Press the TEST button to return to the main menu.

9.2 Compressor/ Fan Motor Test Mode

A test mode is provided on the Variable Speed Outdoor Control (VSODC) to determine if the compressor and outdoor fan motor are operational.

- Enter TEST mode by pressing the TEST button on the VSODC with an insulated probe for one (1) second and release.
- The TEST mode causes the VSODC to do the following:
 - 1) Resets the 5-minute anti-short-cycle timer.
 - 2) Energizes the unit without a call for unit operation.
- If the 5-minute anti-short-cycle timer or 30-second minimum run timer is active (a flashing “c,” “C,” “h,” or “H” is displayed on the dual 7-segment LEDs) and a call for unit operation is present, the TEST mode causes:
 - 1) A “t” to display momentarily on the dual 7-segment display.



- 2) The compressor will start and the outdoor fan

will operate.

- 3) The display will change to a steady “c,” “C,” “h,” or “H” to show the current demand for unit operation.

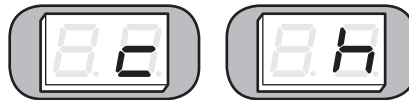

NOTICE: If a call for unit operation is present at the end of the TEST mode, the unit will continue to operate.

- If no call for unit operation is present, the TEST mode causes:
 - 1) A steady “C” to appear on the dual 7-segment LEDs.
- 2) The compressor will start.
 - 3) The compressor will turn off after 5 seconds.



NOTICE: Entering TEST mode without a call for unit operation will cause the compressor to run for 5 seconds.

9.3 Defrost Test Mode

Normal Defrost Test Mode: A defrost test mode can be initiated by pressing the TEST button on the VSODC for 1 second when the system is operating in the heating mode. Upon release of the TEST button, the system will initiate a defrost cycle until the coil temperature reaches the termination temperature or 14 minutes have elapsed. The coil temperature must be below 70°F [21.1°C] or the system will not initiate a defrost test. A “d” will appear on the VSODC display indicating the system is in the defrost mode. Pressing the TEST button while the system is in the Defrost Test Mode will terminate the test mode. If the system initiates and terminates the defrost cycle normally, the system is working properly. Termination of the defrost cycle after the 14 minute maximum time is very unusual and typically indicates a problem with the coil temperature thermistor or it’s wiring connections.

Continuous Defrost Test Mode: The VSODC can be forced into a continuous defrost mode by holding the TEST button down for at least 5 seconds and releasing when the system is in the heating mode. The system will remain in the defrost mode until the TEST button is pressed again. If the system is left in this mode for too long, the High Pressure Control will trip and shut the system down.

9.0 DIAGNOSTICS & TROUBLESHOOTING



9.4 Status and Diagnostic Codes

Descriptions of the VSODC status codes are provided below.

NOTE: Codes must be read from correct side to avoid an error in reading codes.

Dual 7-Segment LEDs Display Code	Status Code Description	Status/Possible Cause – Troubleshooting Information
	c – First-Stage Cooling Unit has received a command for first-stage cooling.	Normal operation
	c – Anti-short-cycle timer (3 minutes) or minimum run timer (30 seconds) active	<ul style="list-style-type: none"> The unit has received a command for first-stage cooling during an active anti-short-cycle timer or minimum run timer. Wait until unit timer has expired or press the TEST button to defeat short-cycle delay.
	C – Second-Stage Cooling Unit has received a command for second-stage cooling.	Normal operation
	C – Anti-short-cycle timer (3 minutes) or minimum run timer (30 seconds) active.	<ul style="list-style-type: none"> The unit has received a command for second-stage cooling during an active anti-short-cycle timer or minimum run timer. Wait until timer has expired or press the TEST button to defeat short-cycle delay.
	d – Defrost Active The unit is undergoing a defrost cycle.	Normal operation
	h – First-Stage Heat Pump Unit has received a command for first-stage heat pump.	Normal operation
	h – Anti-short-cycle timer (3 minutes) or minimum run timer (30 seconds) active.	<ul style="list-style-type: none"> The unit has received a command for first-stage heat pump during an active anti-short-cycle timer or minimum run timer. Wait unit timer has expired or press the TEST button to defeat short-cycle delay.
	H – Second-Stage Heat Pump Unit has received a command for second-stage heat pump.	Normal operation
	H – Anti-short-cycle timer (3 minutes) or minimum run timer (30 seconds) active.	<ul style="list-style-type: none"> The unit has received a command for second-stage heat pump during an active anti-short-cycle timer or minimum run timer. Wait unit timer has expired or press the TEST button to defeat short-cycle delay.
	0 – Standby No command for unit operation	Normal operation

9.0 DIAGNOSTICS & TROUBLESHOOTING



9.4 Status and Diagnostic Codes (cont.)

The error codes below will be displayed at the EcoNet™ Control Center under Service window / Current Faults or in the Fault History and will be time and date stamped. VSODC (Variable Speed Outdoor Unit Control – EcoNet™ control board) fault code is what will be displayed on the VSODC.

EcoNet error code at Control Center	VSODU Fault Code	Description	Possible Resolution(s)	EV2 Drive LED Code
A900_O Inverter Fault – Identity Fault	8	<ul style="list-style-type: none"> The inverter drive itself is not programmed and is not field serviceable. This fault should not occur in the field. 	<ul style="list-style-type: none"> Replace drive. 	LED's unlikely to display anything
T901_O Inverter Fault – Compressor Overcurrent	15	<ul style="list-style-type: none"> Compressor is pulling more current than allowed 	<ul style="list-style-type: none"> Compressor Shorted to Ground – Check resistance of windings to ground. Wiring to compressor or molded plug damaged – Inspect compressor wiring harness. Wire not secure on U, V, or W – Check connections. Defective Drive – Replace Drive 	Yellow 1 or 3 Flashes Or Red 4 Flashes
T902 Inverter Fault – Envelope Protection	31	<ul style="list-style-type: none"> Compressor current outside of predetermined envelope for RPM's 	<ul style="list-style-type: none"> Will display 31 at VSODC at time of fault – Will return to operation after time delay Must occur 15 times in a 24 hour period to be displayed in control center fault history Verify refrigerant charge, often related to overcharge 	
T903_O Inverter Fault – PFC Overcurrent	15	<ul style="list-style-type: none"> PFC (Power Factor Correction) module is detecting high current internally 	<ul style="list-style-type: none"> Check and Replace Choke. If replacement choke and hard reset doesn't solve, replace drive. 	

9.0 DIAGNOSTICS & TROUBLESHOOTING



9.4 Status and Diagnostic Codes (cont.)

The error codes below will be displayed at the EcoNet™ Control Center under Service window / Current Faults or in the Fault History and will be time and date stamped. VSODC (Variable Speed Outdoor Unit Control – EcoNet™ control board) fault code is what will be displayed on the VSODC.

T904_O Inverter Fault – DC Bus Overvoltage	15	<ul style="list-style-type: none"> Verify line voltage to equipment/drive does not exceed maximum allowable voltages Incoming - > 285 VAC DC Bus - > 385 VDC 	<ul style="list-style-type: none"> Correct incoming line voltage issue Replace Drive 	Yellow 7 Flashes
T905_O Inverter Fault – DC Bus Undervoltage	15	<ul style="list-style-type: none"> DC Bus voltage has dropped below acceptable voltage Incoming Voltage < 187 VAC DC Bus Voltage < 175 VDC 	<ul style="list-style-type: none"> Fault will reset when voltage is returned. Early VSODU firmware (Before VSODU Rev 41) may not properly reset this fault. Update VSODU firmware to later revision. Can occur with power flicker due to storms, will reset when voltage returns after delay. Check Incoming Line Voltage to Drive 	Yellow 8 Flashes
A906_O Inverter Fault – AC Input Overvoltage	28	<ul style="list-style-type: none"> Incoming Voltage > 275 VAC 	<ul style="list-style-type: none"> Verify Incoming voltage to Drive by measuring voltage at L1 to L2 	Yellow 10 Flashes
A907_O Inverter Fault – AC Input Undervoltage	27	<ul style="list-style-type: none"> Incoming voltage < 170 VAC 	<ul style="list-style-type: none"> Verify Incoming voltage to Drive by measuring voltage at L1 to L2 	Yellow 9 Flashes
T908_O Inverter Fault – PIM Over-temp	15	<ul style="list-style-type: none"> Indicates the PIM (Power Inverter Module) on the drive is overheated. May stop or fold back compressor RPM 	<ul style="list-style-type: none"> Check Outdoor fan operation Check Condenser coil for cleanliness Check Drive Heat Sink 	Yellow 4 or 18 Flashes
T909_O Inverter Fault – PFC Over-temp	15	<ul style="list-style-type: none"> Indicates the PFC (Power Factor Correction) is overheated. May stop or fold back compressor RPM 	<ul style="list-style-type: none"> Check Outdoor fan operation Check Condenser coil for cleanliness Check Drive Heat Sink 	Yellow 5 or 19 Flashes

9.0 DIAGNOSTICS & TROUBLESHOOTING



9.4 Status and Diagnostic Codes (cont.)

The error codes below will be displayed at the EcoNet™ Control Center under Service window / Current Faults or in the Fault History and will be time and date stamped. VSODC (Variable Speed Outdoor Unit Control – EcoNet™ control board) fault code is what will be displayed on the VSODC.

A910_O Inverter Fault – Lost Rotor Position	15	<ul style="list-style-type: none"> Compressor rotor not matching speed command Measured via Back EMF 	<ul style="list-style-type: none"> Verify Compressor Connections at U, V, W and Molded plug System Grossly Overcharged Compressor Tight or Locked Drive Defective – Solder Bridging 	Yellow 2 Flashes
T911_O Inverter Fault – Current Imbalance	16	<ul style="list-style-type: none"> Compressor Current Imbalance 	<ul style="list-style-type: none"> Verify Compressor Connections at U, V, W and Molded plug Check Compressor Windings for significant differences in resistance. 	Red 14 Flashes
A912_O Inverter Fault – Micro Fault	16	<ul style="list-style-type: none"> Micro on Drive faulted 	<ul style="list-style-type: none"> Hard Reset on Drive If Hard Reset fails, replace Drive 	Red 13 Flashes
A913_O Inverter Fault - PIM Sensor Open	15	<ul style="list-style-type: none"> Power Inverter Module temperature sensor is open 	<ul style="list-style-type: none"> Replace Drive 	Red 2 Flashes
T914_O Inverter Fault – DC Voltage Low	15	<ul style="list-style-type: none"> DC Bus Voltage is running low 	<ul style="list-style-type: none"> Check Incoming Line Voltage at L1 to L2 Voltage on DC Bus is generally 325 to 380VDC. PIM on Drive Defective Replace Drive 	Yellow 17 Flashes
T915_O Inverter Fault – Discharge Temp	16	<ul style="list-style-type: none"> Compressor Discharge Temperature has exceed 235°F degrees and compressor may fold back until temperature is below 200°F 	<ul style="list-style-type: none"> Verify Operating Superheat and Charge Check Reversing Valve for leakage from Discharge to Suction Check DLT Sensor Connection to Drive Verify DLT sensor resistance 	Yellow 6 Flashes

9.0 DIAGNOSTICS & TROUBLESHOOTING



9.4 Status and Diagnostic Codes (cont.)

The error codes below will be displayed at the EcoNet™ Control Center under Service window / Current Faults or in the Fault History and will be time and date stamped. VSODC (Variable Speed Outdoor Unit Control – EcoNet™ control board) fault code is what will be displayed on the VSODC.

A919_O Inverter Fault – PFC/DSP Comm Fault	15	<ul style="list-style-type: none"> Drive lost internal communication between PFC and DSP 	<ul style="list-style-type: none"> Check Mod Bus Cable Hard Reset of Drive If fault persists - replace drive 	Red 9 Flashes
A920_O Inverter Fault – COM/DSP Comm Fault	16	<ul style="list-style-type: none"> Drive lost internal communication between PFC and DSP 	<ul style="list-style-type: none"> Check Mod Bus Cable Hard Reset of Drive If fault persists - replace drive 	Red 8 Flashes
A921_O Inverter Fault – PFC Temp Sensor Open	16	<ul style="list-style-type: none"> Sensor to PFC Is either low or open 	<ul style="list-style-type: none"> Verify proper airflow over the heatsink of the drive. Remove any obstructions.. Check the compressor is operating with in specified limits. 3. If the problem still persists, replace the drive. 	Red 1 Flash
T922_O Inverter Fault – PIM Temp Foldback	15	<ul style="list-style-type: none"> Drive has folded back as a result of PFC temperature 	<ul style="list-style-type: none"> Verify proper airflow over the heatsink of the drive. Remove any obstructions.. Check the compressor is operating with in specified limits. 3. If the problem still persists, replace the drive. 	Yellow 21 Flashes
A925_O Inverter Fault – Compressor Model Unknown	16	<ul style="list-style-type: none"> Drive size and model data card do not match 	<ul style="list-style-type: none"> Incorrect Memory Card has been installed Incorrect Inverter Drive has been installed 	Yellow 22 Flashes

9.0 DIAGNOSTICS & TROUBLESHOOTING



9.4 Status and Diagnostic Codes (cont.)

The error codes below will be displayed at the EcoNet™ Control Center under Service window / Current Faults or in the Fault History and will be time and date stamped. VSODC (Variable Speed Outdoor Unit Control – EcoNet™ control board) fault code is what will be displayed on the VSODC.

A927_O Inverter Fault – DLT sensor Open	15	<ul style="list-style-type: none"> Discharge Line Temperature Sensor is open 	<ul style="list-style-type: none"> Check DLT sensor connection to drive Check DLT sensor resistance to temp 	Red 3 Flashes
A928_O Locked	15	<ul style="list-style-type: none"> This is an indication that the system is locked out and needs to be reset 	<ul style="list-style-type: none"> Check fault history for cause of lockout condition at control center Address fault as indicated in history 	
A929_O 240VAC Missing or Comm Failure <i>(Formerly Comm Failure)</i>	15	<ul style="list-style-type: none"> Drive is either not powered or there is a problem with the mod bus cable between VSODC and Drive 	<ul style="list-style-type: none"> Verify Line voltage to unit is on and is measured by reading line voltage into drive at L1-L2 Check Modbus cable between VSODC and Drive. Closely Examine pins in connectors Hard Reset of Drive Replace Drive 	Red 11 Flashes
A950_O Configuration Data Restore Failure		<ul style="list-style-type: none"> Firmware in VSODC is corrupt 	<ul style="list-style-type: none"> Replace Firmware in VSODC 	
A951_O Memory Card Data Write Failure	11	<ul style="list-style-type: none"> VSODC is unable to write data to memory card 	<ul style="list-style-type: none"> Possible Damage to solder joints on back of memory card socket on VSODC Replace VSODC Replace Memory Card also if VSODC does not resolve 	

9.0 DIAGNOSTICS & TROUBLESHOOTING



9.4 Status and Diagnostic Codes (cont.)

The error codes below will be displayed at the EcoNet™ Control Center under Service window / Current Faults or in the Fault History and will be time and date stamped. VSODC (Variable Speed Outdoor Unit Control – EcoNet™ control board) fault code is what will be displayed on the VSODC.

T952_O Outside Temperature Thermistor Failure	84	<ul style="list-style-type: none"> Outdoor Temperature Thermistor is either Open, Shorted or Low 	<ul style="list-style-type: none"> Check connection at VSODC Verify leads to sensor are not pinched, or damaged Check sensor resistance/temp
A953_O Coil Temperature Thermistor Failure <i>(Formerly called Evap Temperature Thermistor)</i>	83	<ul style="list-style-type: none"> Coil Temperature Thermistor is either Open, Shorted or Low Unit will run in cooling mode, but will not run in heating mode 	<ul style="list-style-type: none"> Check connection at VSODC Verify leads to sensor are not pinched, or damaged Check sensor resistance/temp
A954_O Suction Temperature Thermistor Failure	35	<ul style="list-style-type: none"> Suction Pressure Thermistor is either Open, Shorted, or Low Unit will run in cooling mode but will not run in heating mode 	<ul style="list-style-type: none"> Check connection at VSODC Verify leads to sensor are not pinched, or damaged Check sensor resistance/temp
A956_O Suction Pressure Sensor Failure	36	<ul style="list-style-type: none"> Suction Pressure Transducer in either, shorted, grounded or open or outside of acceptable range. 	<ul style="list-style-type: none"> Check Transducer using formula PSIA = $375 * (\text{DCVout}/\text{DCVin}) - 22.8$ PSIG = PSIA - 14.7 Verify Connections at VSODC and Transducer
T957_O Low Refrigerant Pressure	21	<ul style="list-style-type: none"> Pressure at Suction Pressure Transducer has fallen below 50 PSIG in the cooling mode or 15 PSIG in the heating mode. 	<ul style="list-style-type: none"> Check Refrigerant Charge Check for Restrictions in liquid or suction lines, drier, strainers etc.

9.0 DIAGNOSTICS & TROUBLESHOOTING



9.4 Status and Diagnostic Codes (cont.)

The error codes below will be displayed at the EcoNet™ Control Center under Service window / Current Faults or in the Fault History and will be time and date stamped. VSODC (Variable Speed Outdoor Unit Control – EcoNet™ control board) fault code is what will be displayed on the VSODC.

A957_O Low Refrigerant Pressure	L 21	<ul style="list-style-type: none"> System has tripped the low pressure threshold 3 times in one call. Unit will be locked out for one hour 	<ul style="list-style-type: none"> Check Refrigerant Charge Check for Restrictions in liquid or suction lines, drier, strainers etc. 	Yellow 20 Flashes
T958_O High Refrigerant Pressure	L 29	<ul style="list-style-type: none"> System High pressure switch has opened. 	<ul style="list-style-type: none"> Check Refrigerant Charge Check connection of HPS to Drive 	Yellow 20 Flashes
A958_O High Refrigerant Pressure	L 29	<ul style="list-style-type: none"> System High pressure switch has opened 3 times and is locked out for one hour 	<ul style="list-style-type: none"> Check Refrigerant Charge Check connection of HPS to Drive 	Yellow 20 Flashes
T961_O Compressor Discharge Temperature High		<ul style="list-style-type: none"> Folding back due to high discharge temperature 	<ul style="list-style-type: none"> When Discharge temperature exceeds 235°F, Compressor will slow down to bring discharge temperature down below 200°F. Check system superheat and charge Verify reversing valve is not leaking from discharge to suction. 	Yellow 6 Flashes

Troubleshooting Notes:

If blower will not run but the thermostat / control center, control board and outdoor equipment is otherwise showing to be powered, check low voltage fuse on air handler control board.

If reversing valve will not shift to heating mode, check fuse on VSODC in addition to solenoid and wiring to reversing valve.

If compressor RPM's are not as expected, check LED on drive to see if it is folding back as a result of an issue.

9.0 DIAGNOSTICS & TROUBLESHOOTING



9.5 Active Protection Fault Details

L8 – Compressor Model Unknown – A900_O Inverter Identity Fault

If the inverter compressor model is not set, the inverter will keep the compressor from operation. The VSODC will lock out the compressor to keep it from operating and flash an "L" on the dual 7-segment LEDs followed by a 8.

IMPORTANT: This mode of active protection must be manually reset

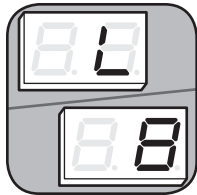

Active Protection – Code
L8 – Compressor Model
Unknown – A900_O
Inverter Identity Fault

15 – Compressor Overcurrent – T901_O Inverter Fault

If the inverter detects an output overcurrent condition to the compressor greater than the compressor/inverter envelope permits, the inverter will automatically begin to slow the compressor operation and reduce the output current. When operating with an ECM outdoor fan motor and in cooling mode the VSODC will increase the outdoor fan speed. When operating in communicating and heating modes the VSODC will request the indoor airflow to be increased to the maximum level permissible for the outdoor unit. If this fold back is not successful in bringing the compressor back into the designed operating envelope then the compressor will be kept from operating.

During either of the above conditions where the compressor has been stopped from operating the VSODC will flash a "15" on the dual 7-segment LED.



L15 – Power Factor Correction Circuit Overcurrent – T903_O Inverter Fault

If the inverter detects an overcurrent condition in the power factor correction circuit the inverter will automatically shut the compressor off and keep it from operation. There is a 5 minute delay after this fault occurs before VSODC will restart the compressor. If this fault occurs 3 times during a single call for operation the VSODC will lock out the compressor to keep it from continuing to operate and flash an "L" on the dual 7-segment LEDs followed by a 15.

IMPORTANT: This mode of active protection must be manually reset

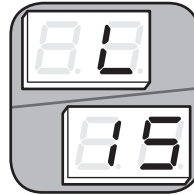

L15 – DC Bus Over Voltage – A904_O Inverter Fault

If the inverter detects an overvoltage condition in the DC bus circuit the inverter will automatically shut the compressor off and keep it from operation. The VSODC will leave the compressor off until the DC bus voltage drops below 380Vdc. At this time the VSODC will restart the compressor. If this fault occurs 3 times in one hour the VSODC will lock out the compressor to keep it from continuing to operate for one hour and flash an "L" on the dual 7-segment LEDs followed by a 15.

IMPORTANT: This mode of active protection must be manually reset.

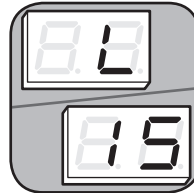

L15 – DC Bus Under Voltage – A905_O Inverter Fault

If the inverter detects an under voltage condition in the DC bus circuit the inverter will automatically shut the compressor off and keep it from operation. The VSODC will leave the compressor off until the DC bus voltage rises above 300Vdc. At this time the VSODC will restart the compressor. If this fault occurs 3 times in one hour the VSODC will lock out the compressor to keep it from continuing to operate for one hour and flash an "L" on the dual 7-segment LEDs followed by a 15.

IMPORTANT: This mode of active protection must be manually reset.

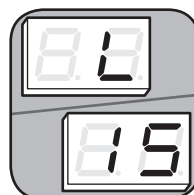

9.0 DIAGNOSTICS & TROUBLESHOOTING



9.5 Active Protection Fault Details (cont.)

L15 – PIM Over-temp – T908_O Inverter Fault

If the inverter detects an over temperature condition in the **Power Module** circuit the inverter will automatically shut the compressor off and keep it from operation. The VSODC will leave the compressor off until the circuit temperature is reduced to acceptable levels. At this time the VSODC will restart the compressor. If this fault occurs 3 times during one call for operation the VSODC will lock out the compressor to keep it from continuing to operate for one hour and flash an "L" on the dual 7-segment LEDs followed by a 15.

IMPORTANT: This mode of active protection must be manually reset.

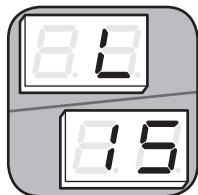

L15 – PFC Over-temp – T909_O Inverter Fault

If the inverter detects an over temperature condition in the **Power Factor Correction** circuit the inverter will automatically shut the compressor off and keep it from operation. The VSODC will leave the compressor off until the circuit temperature is reduced to acceptable levels. At this time the VSODC will restart the compressor. If this fault occurs 3 times during one call for operation the VSODC will lock out the compressor to keep it from continuing to operate for one hour and flash an "L" on the dual 7-segment LEDs followed by a 15.

IMPORTANT: This mode of active protection must be manually reset.



L15 – Lost Rotor Position - A910_O Inverter Fault

If the inverter loses the rotor position in the compressor the inverter will automatically shut the compressor off and keep it from operation. There is a 5 minute delay after this fault occurs before VSODC will restart the compressor. If this fault occurs 3 times during a single call for operation the VSODC will lock out the compressor to keep it from continuing to operate and flash an "L" on the dual 7-segment LEDs followed by a 15.

IMPORTANT: This mode of active protection must be manually reset.

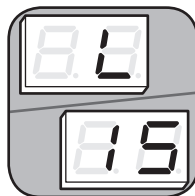

L15 – Current Imbalance – T911_O Inverter Fault

If the inverter identifies an imbalanced current draw between the compressor 3 phase windings, the inverter will automatically shut the compressor off and keep it from operation. There is a 5 minute delay after this fault occurs before VSODC will restart the compressor. If this fault occurs 3 times during a single call for operation the VSODC will lock out the compressor to keep it from continuing to operate and flash an "L" on the dual 7-segment LEDs followed by a 15.

IMPORTANT: This mode of active protection must be manually reset.

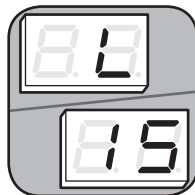

L15 – DC Voltage Low – T914_O Inverter Fault

If the inverter detects a sustained low voltage condition in the DC bus circuit the inverter will automatically shut the compressor off and keep it from operation. The VSODC will immediately restart the compressor. If this fault occurs 3 times during one call for operation the VSODC will lock out the compressor to keep it from continuing to operate and flash an "L" on the dual 7-segment LEDs followed by a 15.

IMPORTANT: This mode of active protection must be manually reset.

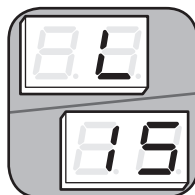

L15 – PIM Temperature High – T917_O Inverter Fault

If the inverter identifies a high **Power Module** temperature thermistor reading the inverter will

9.0 DIAGNOSTICS & TROUBLESHOOTING



9.5 Active Protection Fault Details (cont.)

automatically shut the compressor off and keep it from operation. If this fault occurs 3 times during one call for operation the VSODC will lock out the compressor to keep it from continuing to operate and flash an "L" on the dual 7-segment LEDs followed by a 15.

IMPORTANT: This mode of active protection must be manually reset.

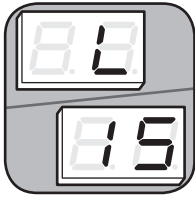

L15 – PFC & IGBT Temperature High – T918_O Inverter Fault

If the inverter identifies a high insulated-gate bipolar transistor (IGBT) temperature or power factor correction (PFC) circuit temperature reading the inverter will automatically shut the compressor off and keep it from operation. If this fault occurs 3 times during one call for operation the VSODC will lock out the compressor to keep it from continuing to operate and flash an "L" on the dual 7-segment LEDs followed by a 15.

IMPORTANT: This mode of active protection must be manually reset.

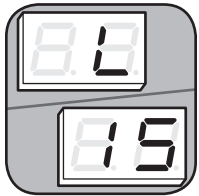

L15 – PIM Temperature Fold back – T922_O Inverter Fault

If the inverter detects a high Power Module temperature the inverter will automatically begin to slow the compressor operation. If this fold back is not successful in bringing the PIM temperature into the acceptable range then the compressor will be kept from operating. If this fault occurs 3 times during one call for operation VSODC will lock out the compressor to keep it from continuing to operate and flash an "L" on the dual 7-segment LEDs followed by a 15.

IMPORTANT: This mode of active protection must be manually reset.

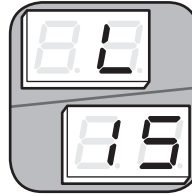

L16 – Microprocessor Fault – A912_O Inverter Fault

If the inverter identifies a faulty microprocessor the inverter will automatically shut the compressor off and keep it from operation. The VSODC will lock out the compressor to keep it from continuing to operate and flash an "L" on the dual 7-segment LEDs followed by a 16.

IMPORTANT: This mode of active protection must be manually reset.

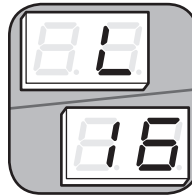

L16 – PIM Temp Sensor Open – A913_O Inverter Fault

If the inverter identifies an open power module temperature thermistor the inverter will automatically shut the compressor off and keep it from operation. The VSODC will lock out the compressor to keep it from continuing to operate and flash an "L" on the dual 7-segment LEDs followed by a 16.

IMPORTANT: This mode of active protection must be manually reset.

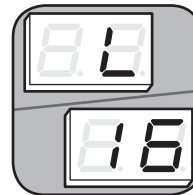

L16 – PFC MCU/DSP Communication Fault – A919_O Inverter Fault

If the inverter identifies a communication fault between the MCU (motor control unit) or DSP (digital signal processor), the inverter will automatically shut the compressor off and keep it from operation. If this fault occurs 3 times during one call for operation the VSODC will lock out the compressor to keep it from continuing to operate and flash an "L" on the dual 7-segment LEDs followed by a 16.

9.0 DIAGNOSTICS & TROUBLESHOOTING



9.5 Active Protection Fault Details (cont.)

IMPORTANT: This mode of active protection must be manually reset.

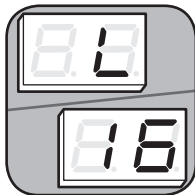

L16 – Com/DSP Comm Fault – A920_O Inverter Fault

If the inverter identifies a communication with the DSP (digital signal processor), the inverter will automatically shut the compressor off and keep it from operation. If this fault occurs 3 times during one call for operation the VSODC will lock out the compressor to keep it from continuing to operate and flash an "L" on the dual 7-segment LEDs followed by a 16.

IMPORTANT: This mode of active protection must be manually reset.



L16 – PFC Temperature Sensor Open – A921_O Inverter Fault

If the inverter identifies an open power factor correction (PFC) temperature thermistor the inverter will automatically shut the compressor off and keep it from operation. The VSODC will lock out the compressor to keep it from continuing to operate and flash an "L" on the dual 7-segment LEDs followed by a 16.

IMPORTANT: This mode of active protection must be manually reset.

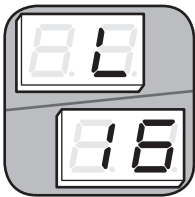

L16 – Discharge Line Temperature Fault – A927_O Inverter Fault

If the inverter identifies a faulty discharge line temperature thermistor the inverter will automatically shut the compressor off and keep it from operation. The VSODC will lock out the compressor to keep it from continuing to operate

and flash an "L" on the dual 7-segment LEDs followed by a 16.

IMPORTANT: This mode of active protection must be automatic reset once the discharge line thermistor fault is corrected.

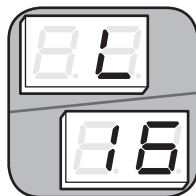

L16 – Discharge Temperature – T916_O Inverter Fault

If the VSODC detects the compressor discharge temperature is greater 235°F [113°C] the VSODC will automatically begin to slow the compressor operation until the temperature is ≤200°F [93°C]. If this fold back is not successful in bringing the compressor discharge temperature below 200°F prior to reaching the minimum compressor speed then the compressor will be kept from operating. After the compressor off delay is complete the VSODC will return the compressor to operation. If this fault occurs 3 times during one call for operation the VSODC will lock out the compressor to keep it from continuing to operate and flash an "L" on the dual 7-segment LEDs followed by a 16.

IMPORTANT: This mode of active protection must be manually reset.

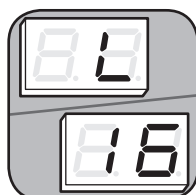

L16 – Communication Failure – A929_O Inverter Fault

If the inverter identifies a communication error with the VSODC, the inverter will automatically shut the compressor off and keep it from operation. When this fault occurs the VSODC will lock out the compressor to keep it from operating and flash an "L" on the dual 7-segment LEDs followed by a 16.

IMPORTANT: This mode of active protection must be manually reset.

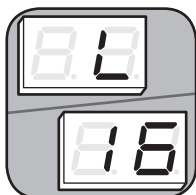

9.0 DIAGNOSTICS & TROUBLESHOOTING



9.5 Active Protection Fault Details (cont.)

16 – HP Sensor Not Configured – T926_O

If the inverter is not configured or does not hold the configuration for the high pressure switch in the Modbus register, the inverter will provide this fault.



L16 – Brown Out Fault – A959_O Brown Out Fault

If the inverter detects input AC voltage < 155VAC for 4 seconds the VSODC will automatically shut the compressor off and keep it from operation. The VSODC will leave the compressor off until the input AC voltage increases to >175VAC for 4 seconds. At this time the VSODC will restart the compressor. While the compressor is off the VSODC will display a 16 on the dual 7-segment LEDs.

IMPORTANT: This mode of active protection is automatically reset.



L21 – Low Pressure Refrigerant – A/T 021_0 Low Refrigerant Pressure

- The VSODC will display a flashing “21” followed by a flashing “L” when a low-pressure control lockout occurs.

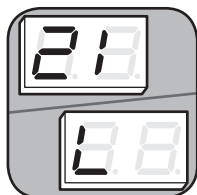

Active Protection – Code 21L – Open low-pressure control

IMPORTANT: This mode of active protection must be manually reset.

- The VSODC addresses low-pressure control faults differently depending on the mode of unit operation (cooling or heating mode).

Cooling Mode

- If the LPC opens three (3) times during the same call for cooling operation, the VSODC will lock out the compressor to keep it from continuing to operate and flash a “21” on the dual 7-segment LEDs followed by an “L.”

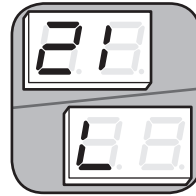

Active Protection – Code 21L – Open low-pressure control

IMPORTANT: This mode of active protection must be manually reset.

Heating Mode

- There are two scenarios that will cause active protection during an LPC trip when the unit is in the heating mode:

Active Protection With Hard Lockout:

- If the LPC opens three (3) times within 120 minutes for the same call for heating operation, the VSODC will lock out the compressor to keep it from continuing to operate and flash an “21” on the dual 7-segment LEDs followed by a “L.”

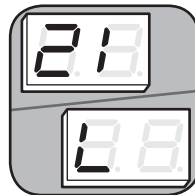

Active Protection – Code 21L – Open low-pressure control

IMPORTANT: This mode of active protection must be manually reset.

Active Protection With Soft Lockout:

- If the LPC opens three (3) times for the same call for heating and the outdoor ambient temperature is below -10°F [-23°C], the VSODC will lock out the compressor to keep it from continuing to operate and flash a “21” on the dual 7-segment LEDs followed by an “L.” Once the outdoor ambient rises above -10°F [-23°C], the VSODC will clear active protection automatically.

IMPORTANT: This mode of active protection will automatically deactivate once the outdoor temperature rises above -10°F [-23°C]. Wait until the outdoor ambient temperature rises above -10°F [-23°C] before performing further diagnostics.

27- AC Input Under Voltage – A907_O_Inverter Fault

If the inverter detects input AC under voltage the VSODC will automatically shut the compressor off and keep it from operation. The VSODC will leave the compressor off until the input AC voltage

9.0 DIAGNOSTICS & TROUBLESHOOTING



9.5 Active Protection Fault Details (cont.)

increases to $\geq 187\text{VAC}$. At this time the VSODC will restart the compressor. While the compressor is off the VSODC will display a 27 on the dual 7-segment LEDs.

IMPORTANT: This mode of active protection is automatically reset.



28 – AC Input Over Voltage – A906_O Inverter Fault

If the inverter detects input AC over voltage the VSODC will automatically shut the compressor off and keep it from operation. The VSODC will leave the compressor off until the input AC voltage reduces to $\leq 252\text{VAC}$. At this time the VSODC will restart the compressor. While the compressor is off the VSODC will display a 28 on the dual 7-segment LEDs.

IMPORTANT: This mode of active protection is automatically reset.



L29 – High Refrigerant Pressure – A/T 923_O High Refrigerant Pressure

- If the HPC opens three (3) times during the same call for unit operation, the VSODC will lock out the compressor to keep it from continuing to operate and flash a “29” on the dual 7-segment LEDs followed by an “L.”

IMPORTANT: This mode of active protection must be manually reset.



31 – Compressor Envelope Protection- T902_O Inverter Fault – Envelope Protection

If the inverter detects the calculated compressor torque is greater than the designed operating envelope permits the inverter will automatically begin to slow the compressor operation. If this fold back is not successful in bringing the compressor back into the designed operating envelope then the compressor will be kept from operating.

IMPORTANT: It is common during startup and shutdown for the compressor to venture outside the designed operating envelope. It is possible this fault can be seen on an installation when there is nothing wrong with the installation. For this reason the VSODC will auto reset and return the system to operational condition after the compressor delay is complete.

Prior to restarting the compressor the VSODC 7-segment display will flash a “31”.

35 – Suction Temperature Thermistor Failure – A102_O

If the VSODC identifies an issue with Outdoor Suction Thermistor (OST) sensor the VSODC will flash a 35 on the dual 7-segment LEDs.

IMPORTANT: This mode of active protection is automatically reset once the OAT sensor failure is corrected.

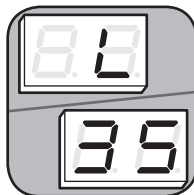

36 – Suction Pressure Sensor Failure – A956_O

If the VSODC identifies an issue with the Suction Pressure Transducer (SPT) sensor the VSODC will flash a 36 on the dual 7-segment LEDs.

IMPORTANT: This mode of active protection is automatically reset once the OAT sensor failure is corrected.

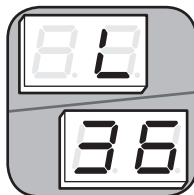

9.0 DIAGNOSTICS & TROUBLESHOOTING



9.5 Active Protection Fault Details (cont.)

83 – Evaporator Temperature Thermistor Failure – T953_O

If the VSODC identifies an issue with the Evaporator Temperature Thermistor (EVAPIN) sensor the VSODC will flash an 83 on the dual 7-segment LEDs.

IMPORTANT: This mode of active protection is automatically reset once the OAT sensor failure is corrected.



84 – Outside Ambient Thermistor Failure - T952

If the VSODC identifies an issue with the Outdoor Ambient Thermistor (OAT) sensor the VSODC will flash an 84 on the dual 7-segment LEDs.

IMPORTANT: This mode of active protection is automatically reset once the OAT sensor failure is corrected.

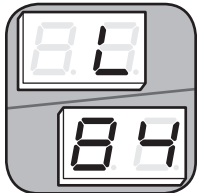

93 – Configuration Data Restore Failure – A950_O

If the VSODC identifies issue(s) reading the model data from the memory card, the VSODC will automatically shut the compressor off and keep it from operation. When this fault occurs the VSODC will lock out the compressor to keep it from operating and flash an "L" on the dual 7-segment LEDs followed by a 93.

IMPORTANT: This mode of active protection must be manually reset.

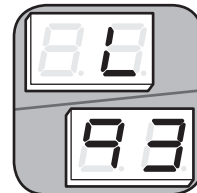

D1 – Memory Card Configuration Data Write Failure – A951_O

If the VSODC identifies issue(s) writing the model data from the memory card, the VSODC will automatically shut the compressor off and keep it from operation. When this fault occurs the VSODC will lock out the compressor to keep it from operating and flash an "D1" on the dual 7-segment LEDs.

IMPORTANT: This mode of active protection must be manually reset.

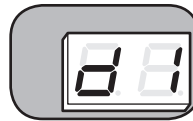

9.0 DIAGNOSTICS & TROUBLESHOOTING



9.6 Electrical Checks Flowchart

THERMOSTAT CALL FOR COOLING OPERATION, NO COOLING OPERATION

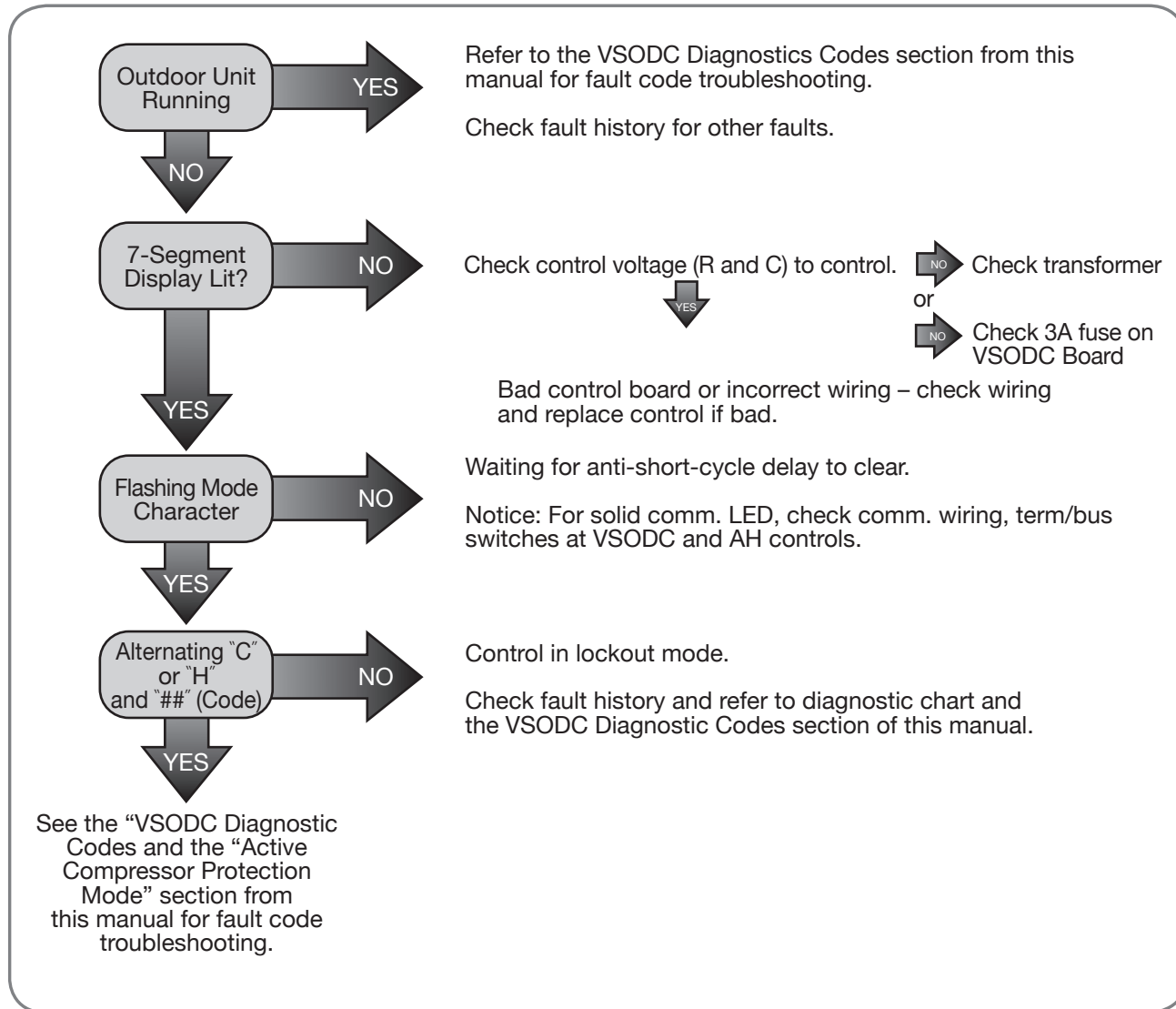

9.0 DIAGNOSTICS & TROUBLESHOOTING



9.7 Cooling Mechanical Checks Flowchart

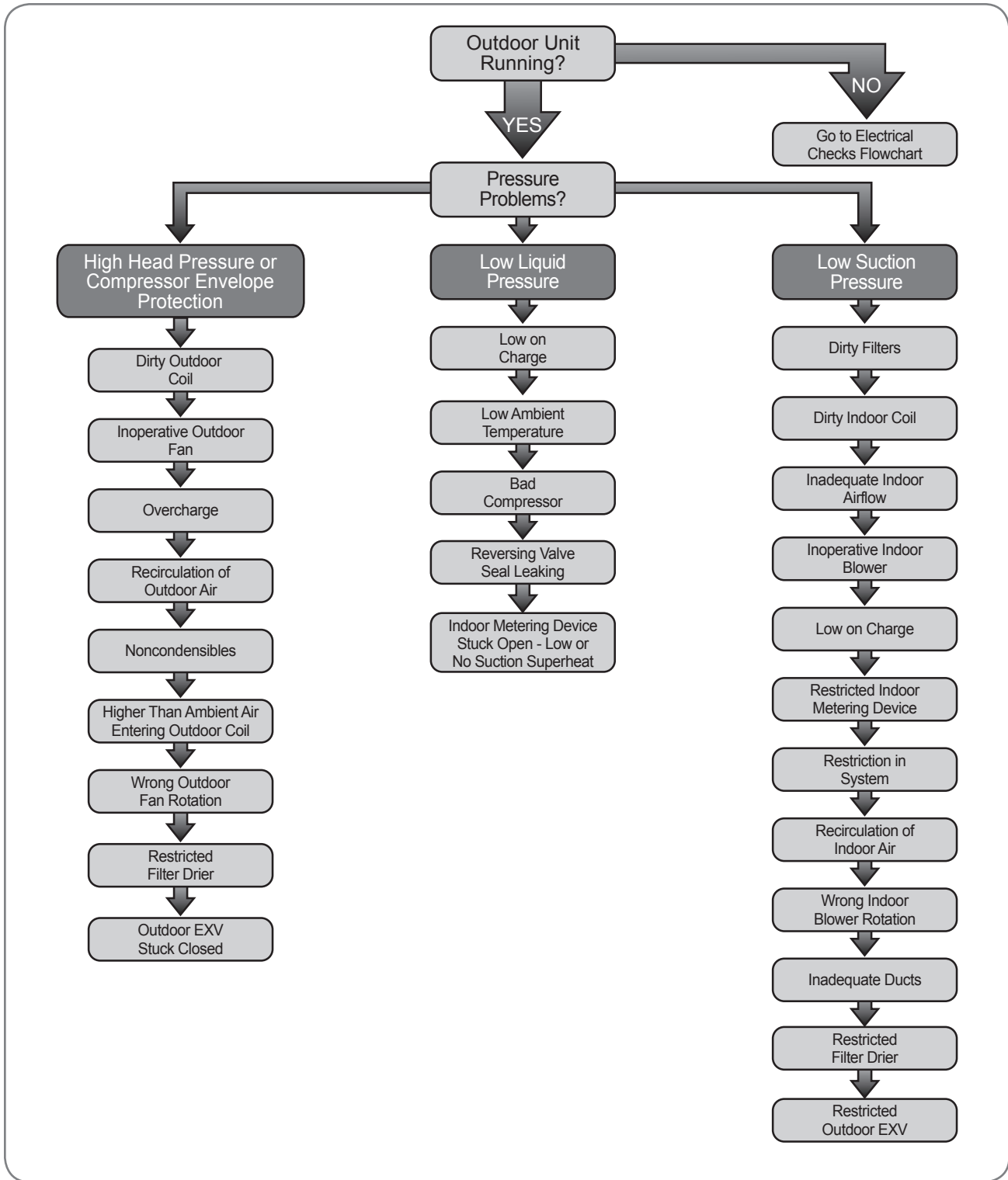

9.0 DIAGNOSTICS & TROUBLESHOOTING



9.8 Heating Mechanical Checks Flowchart

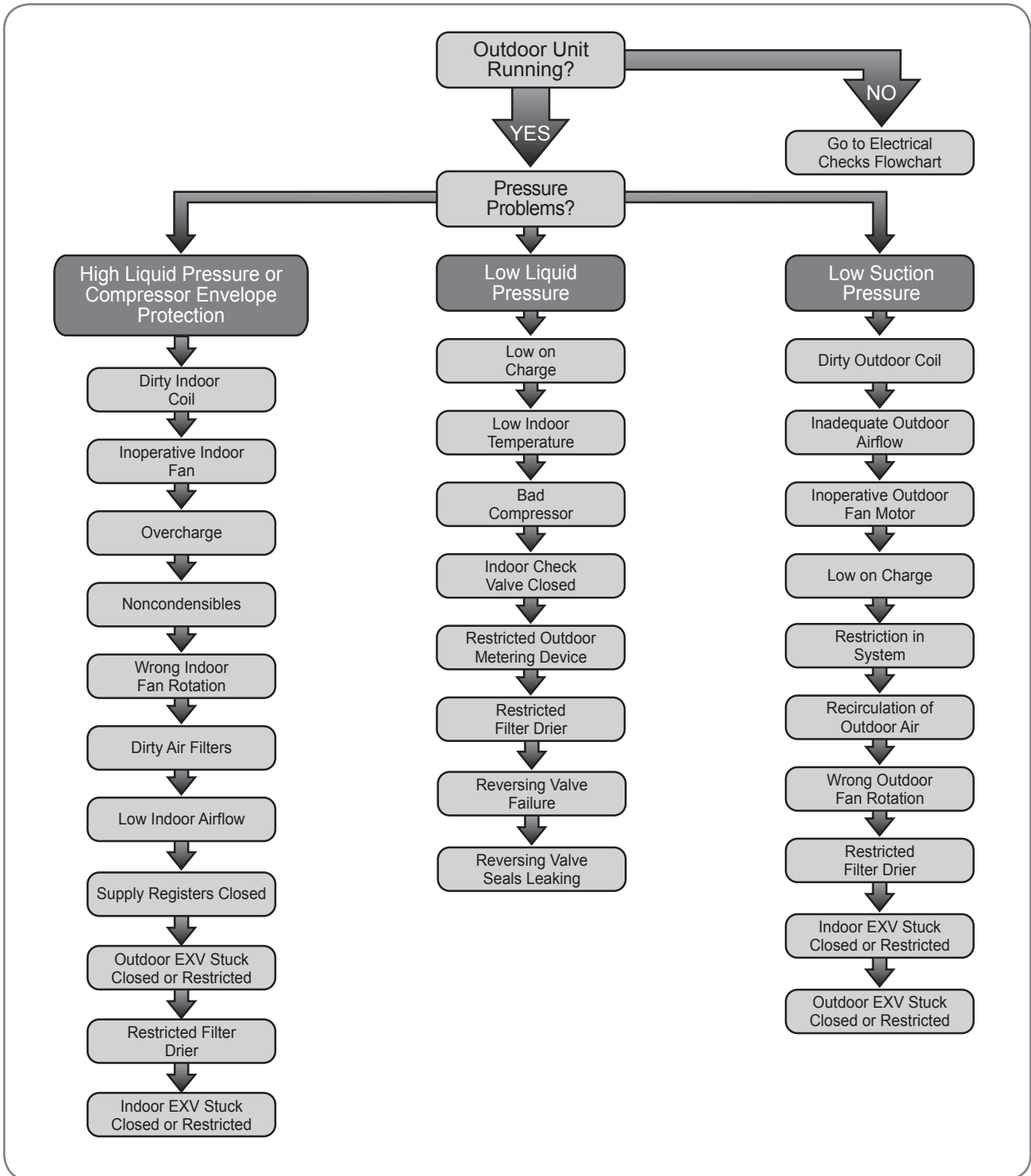

9.0 DIAGNOSTICS & TROUBLESHOOTING



9.9 Defrost Mechanical Checks Flowchart

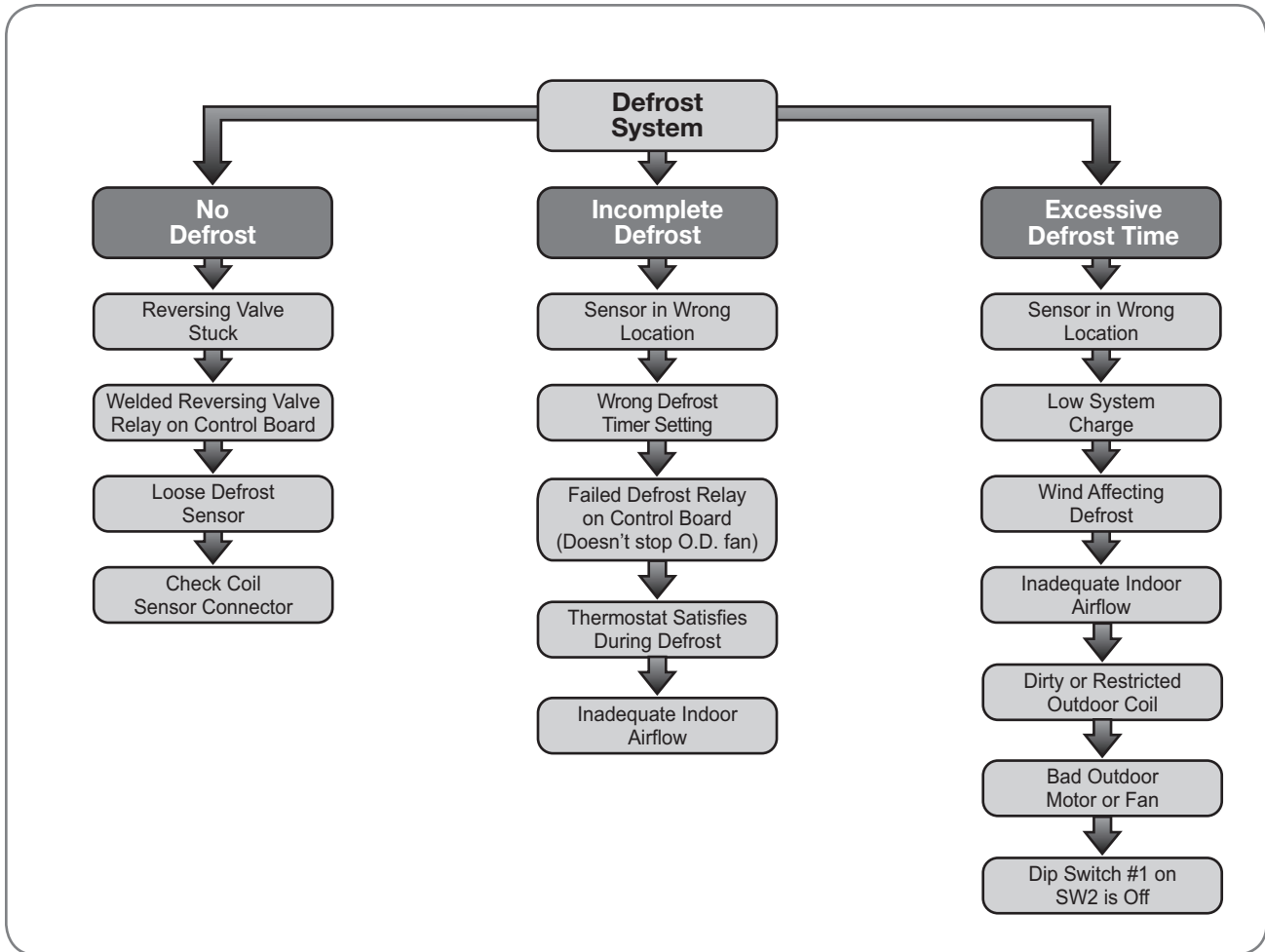

9.0 DIAGNOSTICS & TROUBLESHOOTING



9.10 Checking Transducers & Temperature Sensors

TRANSDUCERS:

Checking transducers for accuracy can be tricky at best. A technician will be required to do some voltage reading and algebraic math to validate the transducer is functioning properly. Additionally, comparing it to a reliable source can also be a challenge. Unless the gauges have been calibrated recently, the question remains, which one is right? To make matters even slightly more challenging, the technician will need to convert PSIA (Absolute Pressure) to PSIG (Gauge Pressure) because the latter is the one we work with in the field.

Knowing where to take the measurement, and getting solid reading is crucial. Measurements are done in the 0-5 volt DC range. One confusing point may be that we will take our measurements OUT and IN to the control, which are reversed when we talk formulas because we want the IN and OUT of the transducer. For instance, 5VDC out of the control board, translates to 5VDC into the transducer. And the lower variable voltage output from the transducer will be the input to the control board.

The transducer is not removed or disconnected to make these checks. The technician's meter leads need to be the smaller needle type, or actual needles can be used to gain access to the points of measurements.

Starting with the formula which results in the PSIA, we can then convert to PSIG.

SUCTION LINE TRANSDUCER:

$$\text{PSIA} = 375 * (\text{VDC out} / \text{VDC in}) - 22.8$$
$$\text{PSIG} = \text{PSIA} - 14.7$$

LIQUID LINE TRANSDUCER:

$$\text{PSIA} = 812.5 * (\text{VDC out} / \text{VDC in}) - 66.55$$
$$\text{PSIG} = \text{PSIA} - 14.7$$

Formulas such as this require us to follow some basic algebraic rules. The order of operations is called PEMDAS. (Parentheses, Exponents, Multiplication, Division, Addition, and Subtraction). Our formula doesn't have any Exponents so we can eliminate that. Also, there is no Addition. Multiplication and Division, similar to Addition and Subtraction priority comes to whichever is first in the formula. In our case, this doesn't matter because the Division is within the parentheses which comes first anyway.

Starting with some arbitrary numbers completion of the formula should look like this:

SUCTION LINE TRANSDUCER:

$$\text{VDC out} = 2.4$$
$$\text{VDC in} = 5.1$$

So...

$$\text{PSIA} = 375 * (2.4 / 5.1) - 22.8$$
$$\text{PSIA} = 375 * (0.47) - 22.8$$
$$\text{PSIA} = 176.25 - 22.8$$
$$\text{PSIA} = \mathbf{153.45}$$

LIQUID LINE TRANSDUCER:

$$\text{VDC out} = 3.4$$
$$\text{VDC in} = 5.1$$

So...

$$\text{PSIA} = 812.50 * (3.4 / 5.1) - 66.55$$
$$\text{PSIA} = 812.50 * (0.667) - 66.55$$
$$\text{PSIA} = 541.67 - 66.55$$
$$\text{PSIA} = \mathbf{475.1}$$

In order to get to PSIG, we must subtract 14.7 (Atmospheric Pressure) from our PSIA. This is very important, because if we forget to apply this, we will certainly notice a difference and may otherwise condemn, a properly working transducer.

$$\text{PSIG} = \text{PSIA} - 14.7$$
$$\text{PSIG} = 153.45 - 14.7$$
$$\text{PSIG} = \mathbf{138.75}$$

So when should we check this? Should the system be running or static? Well, if we were looking at the indoor transducer, it probably should be off and stable. We may need to remove the transducer to check the pressure at the same port. If it's outside, our gauge port at the vapor service valve should be close enough in proximity.

Where do we take our voltage measurements? With the system powered, we will use our smaller meter tips and get our voltage from the back of the transducer harness where it plugs into the control board. Voltage In will be measured from the Red and Black wires. (Red is +, Black is -). This should be very close to 5VDC, but may vary by a few 1/10ths. Our Voltage Out will be measured from Green to Black. (Green is the variable +, Black remains -).

Now we can apply the formula.

9.0 DIAGNOSTICS & TROUBLESHOOTING

9.10 Checking Transducers & Temperature Sensors (cont.)

TEMPERATURE SENSORS:

All the temperature sensors/thermistors used in the equipment use the same scale of 10,000 Ohms at 77°F (25°C). This means, a sensor exposed to 77°F will show a resistance of 10,000 Ohms +/- 1%. As the temperature decreases, the resistance increases. Alternatively, as the temperature increases, the resistance decreases.

Measurements will be made with the sensor disconnected from the control board. Again, comparing the results must be done against a calibrated tester.

A glass of water, mixed completely with ice chips and given several minutes to settle should measure 32 to 32.4°F.

Apply resistance measurements to the chart found below and compare to the control.

32° will have a resistance +/- 1% of 32,650 Ohms.

In the event Celsius is being used, the Fahrenheit temperature will need to be converted.

$$^{\circ}\text{C} = (^{\circ}\text{F} - 32) * 5 / 9$$

Example using 82°F

$$^{\circ}\text{C} = (82 - 32) * 5 / 9$$

$$^{\circ}\text{C} = (50) * 5 / 9$$

$$^{\circ}\text{C} = 250 / 9$$

$$^{\circ}\text{C} = 27.8$$

Temp F°	Ohms	Temp F°	Ohms	Temp F°	Ohms	Temp F°	Ohms
0	85,378	33	31,738	66	13,138	99	5,961
1	82,710	34	30,855	67	12,811	100	5,827
2	80,135	35	30,000	68	12,493	101	5,697
3	77,649	36	29,171	69	12,184	102	5,570
4	75,249	37	28,376	70	11,883	103	5,446
5	72,931	38	27,589	71	11,591	104	5,326
6	70,693	39	26,834	72	11,307	105	5,208
7	68,531	40	26,103	73	11,031	106	5,094
8	66,442	41	25,394	74	10,762	107	4,982
9	64,475	42	24,706	75	10,501	108	4,873
10	62,475	43	24,039	76	10,247	109	4,767
11	60,592	44	23,393	77	10,000	110	4,663
12	58,771	45	22,766	78	9,760	111	4,562
13	57,012	46	22,158	79	9,526	112	4,464
14	55,311	47	21,568	80	9,298	113	4,368
15	53,667	48	20,996	81	9,077	114	4,274
16	52,077	49	20,441	82	8,862	115	4,183
17	50,540	50	19,902	83	8,651	116	4,094
18	49,054	51	19,379	84	8,448	117	4,007
19	47,616	52	18,872	85	8,250	118	3,922
20	46,225	53	18,379	86	8,056	119	3,839
21	44,880	54	17,902	87	7,868	120	3,758
22	43,578	55	17,438	88	7,685	121	3,679
23	42,318	56	16,987	89	7,507	122	3,602
24	41,099	57	16,550	90	7,333	123	3,527
25	39,920	58	16,125	91	7,164	124	3,453
26	38,778	59	15,713	92	7,000	125	3,382
27	37,672	60	15,312	93	6,839	126	3,312
28	36,602	61	14,923	94	6,683	127	3,243
29	35,566	62	14,545	95	6,531	128	3,177
30	34,563	63	14,178	96	6,383	129	3,112
31	33,591	64	13,822	97	6,238	130	3,048
32	32,650	65	13,475	98	6,098		

9.0 DIAGNOSTICS & TROUBLESHOOTING



9.11 General Troubleshooting Guide

⚠️ WARNING: Disconnect all power to unit before servicing. Contactor may break only one side. Failure to shut off power can cause electrical shock resulting in personal injury or death.

SYMPTOM	POSSIBLE CAUSE	REMEDY
Unit will not run	<ul style="list-style-type: none"> Power off or loose electrical connection Thermostat set too high or low. Unit in active compressor protection lockout mode Blown fuses/tripped breaker Transformer defective High-pressure control lock-out Low-pressure control lock-out Miswiring of communications (communication light on continuously) Defective control board 	<ul style="list-style-type: none"> Check for correct voltage at line voltage connections in condensing unit. Reset – Power cycle high and low voltage to outdoor unit. Check control board diagnostic codes. Replace fuses/reset breaker. Check wiring. Replace transformer. Reset by cycling power to unit. Also see high head pressure and low suction pressure remedies. Check for refrigerant leaks. Check communication wiring.
Outdoor fan runs, compressor doesn't	<ul style="list-style-type: none"> Loose connection Communication cable disconnected or failed Compressor stuck, grounded or open motor winding, open internal overload. Low-voltage condition 	<ul style="list-style-type: none"> Check for correct voltage at filter and inverter. Check and tighten all connections. Check control board diagnostic codes. Replace
Insufficient cooling	<ul style="list-style-type: none"> Improperly sized unit Improper indoor airflow Incorrect refrigerant charge Air, noncondensibles, or moisture in system Restricted Refrigerant Circuit 	<ul style="list-style-type: none"> Recalculate load. Check airflow. Should be approximately 400 CFM per ton. Charge per procedure attached to unit service panel. Recover refrigerant. Evacuate and recharge. Replace filter drier. Locate restriction and clear
Compressor short cycles	<ul style="list-style-type: none"> Incorrect voltage Improperly sized unit Refrigerant undercharge or overcharge (LPC or HPC Cycling) 	<ul style="list-style-type: none"> At inverter input terminals, voltage must be between 187-252 VAC when unit is operating. Adjust charge per charging chart.
Registers sweat	<ul style="list-style-type: none"> Low indoor airflow 	<ul style="list-style-type: none"> Increase speed of blower or reduce restriction. Replace air filter.
High head, low vapor pressures	<ul style="list-style-type: none"> Restriction in liquid line, expansion device, or filter drier Stuck EXV 	<ul style="list-style-type: none"> Remove or replace defective component. Verify EXV operation.
High head, high or normal vapor pressure – Cooling mode	<ul style="list-style-type: none"> Dirty outdoor coil Refrigerant overcharge Outdoor fan not running Air or noncondensibles in system 	<ul style="list-style-type: none"> Clean coil. Correct system charge. Repair or replace. Recover refrigerant. Evacuate and recharge.
Low head, high vapor pressures	<ul style="list-style-type: none"> EXV in bypass mode Reversing Valve leaking by Bad compressor 	<ul style="list-style-type: none"> Verify thermostat connections at EXV control Verify thermistor and pressure transducer connection and operation Replace reversing valve Replace compressor.
Low vapor, cool compressor, iced indoor coil	<ul style="list-style-type: none"> Low indoor airflow Operating below 55°F outdoors Moisture in system Low ambient cooling not operating (coil or ambient thermistor failure) 	<ul style="list-style-type: none"> Increase speed of blower or reduce restriction. Replace air filter. Recover refrigerant. Evacuate and recharge. Replace filter drier.
High vapor pressure	<ul style="list-style-type: none"> Excessive load Defective compressor 	<ul style="list-style-type: none"> Recheck load calculation. Replace compressor.
Fluctuating head and vapor pressures	<ul style="list-style-type: none"> EXV hunting Air or noncondensibles in system 	<ul style="list-style-type: none"> Check thermistor to vapor line connection. Check air distribution on coil. Check suction thermistor and pressure transducer operation Recover refrigerant. Evacuate and recharge. Remove & confirm EXV movement. Clean EXV inside with nitrogen to remove any debris then reinstall
Gurgle or pulsing noise at expansion device or liquid line	<ul style="list-style-type: none"> Air or noncondensibles in system Undercharge long line application 	<ul style="list-style-type: none"> Recover refrigerant. Evacuate and recharge. Adjust charge per charging chart.

9.0 DIAGNOSTICS & TROUBLESHOOTING



9.12 Service Analyzer Charts

COMPRESSOR OVERHEATING – HIGH DISCHARGE TEMP			
SYMPTOM	POSSIBLE CAUSE	CHECK/REMEDY	
High superheat (greater than 15°F [-8.3°C] at coil)	Low charge	Check system charge.	
	Verify suction thermistor operation (10k thermistor)	Replace thermistor.	
	Verify pressure transducer operation input and output voltage	Replace thermistor and/or harness and/or control board.	
	Faulty metering device, inadequate suction thermistor or pressure transducer operation.	Restricted cap tube, EXV	
		Foreign matter stopping flow	
	High internal load	Hot air (attic) entering return	
		Heat source on; miswired or faulty control	
	Restriction in liquid line	Drier plugged.	
		Line kinked.	
Low head pressure	Low charge		
	Operating in low ambient temperatures		
Vapor or liquid line subjected to high heat source	Hot attic		
	Hot water line		
Low line voltage	Loose wire connections	Check wiring.	
	Power company problem, transformer	Report problem.	
	Undersized wire feeding unit	Correct and complete diagnosis.	
High line voltage	Power company problem	Report problem.	
High head pressure	Overcharge	Check system charge.	
	Dirty heat pump coil	Clean coil.	
	Faulty or wrong size heat pump fan motor	Replace fan motor.	
	Faulty fan blade or wrong rotation	Replace fan blade.	
		Replace with correct rotation motor.	
	Recirculation of air	Correct installation.	
	Additional heat source	Check for dryer vent near unit.	
		Check for recirculation from other equipment.	
Noncondensibles	Recover refrigerant. Evacuate and recharge system.		
Equipment not matched	Correct mismatch.		
Short cycling of compressor	Cycling or faulty pressure control	Check pressure and address cause of high or low pressure. Replace pressure control if faulty.	
	Loose wiring	Check unit wiring.	
	Thermostat	Located in supply air stream	
		Differential setting too close	
		Customer misuse	
	EXV restricted or not functioning properly	Internal foreign matter	
		Pressure transducer failure	
		Suction thermistor failure	
		EXV control failure	
		EXV coil failure	
		Distributor tube/tubes restricted	
	Distributor tube	Restricted with foreign matter	
Kinked			
Inside diameter reduced from previous compressor failure			

9.0 DIAGNOSTICS & TROUBLESHOOTING



9.12 Service Analyzer Charts (cont.)

COMPRESSOR OVERHEATING – HIGH DISCHARGE TEMP (cont.)		
SYMPTOM	POSSIBLE CAUSE	CHECK OR REMEDIES
Short cycling of compressor (cont.)	Low charge	Check system charge.
	Low evaporator airflow	Dirty coil
		Dirty filter
		Duct too small or restricted
Faulty internal overload	Replace compressor.	
ELECTRICAL		
SYMPTOM	POSSIBLE CAUSE	CHECK OR REMEDIES
Voltage present on load side of inverter and compressor won't run	Communication failure from VSODC to inverter.	Check communication harness connectors and wire continuity.
	Compressor windings	Check for correct ohms.
187 – 252VAC present at input to inverter	Thermostat	Check for control voltage to contactor coil.
	Compressor control circuit	High-pressure switch
		Low-pressure cut-out
		Ambient thermostat
		Stater heat is active
Compressor timed off/on control or interlock		
No voltage at input to inverter	Blown fuses or tripped circuit breaker	Check for short in wiring or unit.
	Improper wiring	Recheck wiring diagram.
Improper voltage	High voltage	Wrong unit
		Power supply problem
	Low voltage	Wrong unit
		Power supply problem
		Wiring undersized
		Loose connections
FLOODED STARTS		
SYMPTOM	POSSIBLE CAUSE	CHECK OR REMEDIES
Liquid in the compressor shell	Faulty stator heat circuit (single leg output to compressor)	Check inverter for single leg output power and correct wiring.
Too much liquid in system	Incorrect piping	Check piping guidelines.
	Overcharge	Check and adjust charge.

9.0 DIAGNOSTICS & TROUBLESHOOTING



9.12 Service Analyzer Charts (cont.)

Service Analyzer Charts

Diagnostics

CONTAMINATION		
SYMPTOM	POSSIBLE CAUSE	REMEDY
Moisture	Poor evacuation on installation or during service	In each case, the cure is the same. Recover refrigerant, flush system. Add filter driver, evacuate, and recharge.
High head pressure	Noncondensibles air	
Unusual head and suction pressure readings	Wrong refrigerant or mixed refrigerants	
Foreign matter – copper filings	Copper tubing cuttings	
Copper oxide	Dirty copper piping or nitrogen not used when brazing	
Welding scale	Nitrogen not used during brazing	
Soldering flux	Adding flux before seating copper partway	
Excess soft solder	Wrong solder material	
LOSS OF LUBRICATION		
SYMPTOM	POSSIBLE CAUSE	REMEDY
Compressor failures	Vapor line tubing too large	Reduce tubing size to improve oil return.
Low suction pressure	Low charge	Check system charge.
	Refrigerant leaks	Repair and recharge.
Cold, noisy compressor – Slugging	Dilution of oil with refrigerant	Observe piping guidelines.
Noisy compressor	Migration	Check stater heat and compressor thermistor.
Cold, sweating compressor	Flooding	Check system charge.
Low load	Reduced airflow	Dirty filter
		Dirty coil
		Wrong duct size
		Restricted duct
	Thermostat setting	Advise customer.
Short cycling of compressor	Cycling or faulty high or low pressure control	Check pressure and address cause of any abnormal pressure. Replace control if faulty.
	Loose wiring	Check all control wires.
	Thermostat	In supply air stream, out of calibration
		Customer misuse
LIQUID REFRIGERANT SLUGGING		
SYMPTOM	POSSIBLE CAUSE	REMEDY
On start-up	Incorrect piping	Review pipe size guidelines.
EXV hunting when running	Faulty EXV components	Check EXV, suction pressure transducer, and suction thermistor for operation.

9.0 DIAGNOSTICS & TROUBLESHOOTING



9.12 Service Analyzer Charts (cont.)

REFRIGERANT FLOOD BACK			
SYMPTOM	POSSIBLE CAUSE	REMEDY	
Poor system control using an EXV	Bad pressure reading	Check transducer wiring.	
	Suction thermistor in wrong location	Relocate thermistor.	
	Bad suction thermistor	Replace thermistor.	
	Improper superheat setting (less than 5°F [-2.8°C])	Adjust EXV SH setpoint dipswitches and validate valve operation.	
ELECTRONIC EXPANSION VALVES			
SYMPTOM	POSSIBLE CAUSE	REMEDY	
High Superheat, Low Suction Pressure (superheat over 15°F [8.3°C])	Moisture freezing and blocking valve	Recover charge, replace filter-drier, evacuate system, recharge.	
	Dirt or foreign material blocking valve	Recover charge, replace filter-drier, evacuate system, recharge	
	Low refrigerant charge	Correct the charge.	
	Vapor bubbles in liquid line		Remove restriction in liquid line. Correct the refrigerant charge.
			Remove noncondensable gases.
			Size liquid line correctly.
	Undersized EXV	Replace with correct valve.	
	Incorrectly sensing vapor line temperature	Verify suction thermistor resistance is correct and properly attached and insulated to the vapor line.	
	Suction thermistor incorrectly calibrated.	Replace suction thermistor assembly.	
	Vapor pressure measured incorrectly.		After verifying lack of connectivity, replace the pressure transducer or harness.
			If harness has a short, replace harness
			If gauge pressure measurement and the converted voltage readings at the control are different replace pressure transducer
			If gauge pressure measurement and the converted voltage readings at the control are the same, replace the control.
	EXV is stuck		Remove EXV from the system and purge with nitrogen, replace filter drier, and recharge.
			If EXV will not open, validate EXV wiring harness and rotor resistance between the black wire and the other 4 wires.
		If none of the above rectifies the issue, replace EXV and filter drier and recharge.	
VSODC dc circuit failed	Verify 5Vdc to pressure transducer is present. If not, replace VSODC.		
High superheat adjustment	Change the superheat offset dip switches to increase superheat.		

9.0 DIAGNOSTICS & TROUBLESHOOTING



9.12 Service Analyzer Charts (cont.)

ELECTRONIC EXPANSION VALVES (cont.)		
SYMPTOM	POSSIBLE CAUSE	REMEDY
Valve feeds too much refrigerant, with low superheat, with low superheat and higher than normal suction pressure.	Moisture causing valve to stick open.	Recover refrigerant, replace filter-drier, evacuate system, and recharge.
	Dirt or foreign material causing valve to stick open	Recover refrigerant, replace filter-drier, remove EXV and purge with nitrogen, evacuate system, and recharge.
		If EXV is completely clogged use the VSODC to open the EXV, and purge with nitrogen, replace filter drier, and recharge.
	Oversized EXV	Install correct EXV.
	Incorrect suction thermistor location	Install suction thermistor with the provided stainless steel strap and an additional zip tie between the 10:00 and 2:00 position on suction line, with insulation.
	Low superheat adjustment	Change the superheat offset dip switches to increase superheat.
	Incorrectly sensing vapor line temperature	Verify suction thermistor resistance is correct and properly attached and insulated to the vapor line.
	Suction thermistor incorrectly calibrated.	Replace suction thermistor assembly.
	Vapor pressure measured incorrectly.	After verifying lack of connectivity, replace the pressure transducer or harness.
		If harness has a short, replace harness.
If gauge pressure measurement and the converted voltage readings at the control are different replace pressure transducer.		
If gauge pressure measurement and the converted voltage readings at the control are the same, replace the control.		
Compressor flood back upon start-up	Refrigerant drainage from flooded evaporator	Install trap riser to the top of the evaporator coil.
	Inoperable stator heat	

9.0 DIAGNOSTICS & TROUBLESHOOTING



9.12 Service Analyzer Charts (cont.)

ELECTRONIC EXPANSION VALVES (cont.)		
SYMPTOM	POSSIBLE CAUSE	REMEDY
Superheat is low to normal with low suction pressure	Unequal evaporator circuit loading	Ensure airflow is equally distributed through evaporator.
		Check for blocked distributor tubes.
	Low load or airflow entering evaporator coil	Ensure blower is moving proper air CFM.
		Remove/Correct any airflow restriction.
Superheat and suction pressure fluctuate (valve is hunting)	Expansion valve is oversized.	Install correct EXV
	Section thermistor is affected by liquid refrigerant or refrigerant oil flowing through suction line	Relocate sensing bulb in another position around the circumference of the suction line.
	Unequal refrigerant flow through evaporator circuit	Ensure sensing bulb is located properly.
		Check for blocked distributor tubes.
Moisture freezing and partially blocking EXV	Recover refrigerant, change filter-drier, evacuate system, and recharge.	
Valve does not regulate at all	Pressure transducer not connected or plugged	Connect pressure transducer in proper location, or remove any blockage.
	Suction line thermistor not connected, or installed on heat effected zone.	Install suction line thermistor in correct horizontal clean section of copper pipe.
	Suction line thermistor failed (continuity to control, wire damaged, resistance values incorrect)	Replace suction line thermistor.

9.0 DIAGNOSTICS & TROUBLESHOOTING



9.13 Troubleshooting Tips

COOLING MODE TROUBLESHOOTING TIPS				
SYSTEM PROBLEM	INDICATORS			
	DISCHARGE PRESSURE	SUCTION PRESSURE	SUPERHEAT Normal: 5°–15°F [2.8° – 8.3°C]	SUBCOOLING Normal: See Charging Chart
Overcharge	High	High	Low	High
Undercharge	Low	Low	High	Low
Liquid Restriction (Drier)	Low	Low	High	High
Low Indoor Airflow	Low	Low	Low	Low
Dirty Outdoor Coil	High	High	Low	Low
Low Outdoor Ambient Temperature	Low	Low	High	High
Inefficient Compressor	Low	High	High	High
Bad Indoor Suction Pressure Transducer or Faulty Measurement	Low	Low	High	High
Poorly Insulated Indoor Vapor Line Thermistor or Bad Thermistor	High	High	Low	Low

HEATING MODE TROUBLESHOOTING TIPS				
SYSTEM PROBLEM	INDICATORS			
	DISCHARGE PRESSURE	SUCTION PRESSURE	SUPERHEAT Normal: 5°–15°F [2.8° – 8.3°C]	SUBCOOLING Normal: See Charging Chart
Overcharge	High	High	OK	High
Undercharge	Low	Low	OK or High	Low
Liquid Restriction (Drier)	Low	Low	High	High
Low Outdoor Airflow	Low	Low	Low	Low
Dirty Indoor Coil	High	High	Low	Low
Low Indoor Ambient Temperature	Low	Low	OK	High
Inefficient Compressor	Low	High	High	High
Bad Outdoor Suction Pressure Transducer or Faulty Measurement	Low	Low	High	High
Poorly Insulated Outdoor Vapor Line Thermistor or Bad Thermistor	High	High	Low	Low

10.0 OUTDOOR UNIT MAINTENANCE



10.1 Outdoor Coil Cleaning

The outdoor fan draws air across the coil during operation which results in contaminants collecting on and between the aluminum fins. These contaminants restrict the air-flow through the coil resulting in reduced capacity and efficiency and increases the temperature of the components that can reduce their life. Therefore, it is recommended that the outdoor coil be cleaned at least annually by a qualified service technician using a non-corrosive coil cleaner and low pressure water hose sprayer. Care must be taken not to damage or flatten out the fins by spraying the fins from

an angle. Washing from the top of the coil down from the inside out is the most effective method of cleaning the coil. The exterior louver panels and unit top are easily removable to facilitate the coil cleaning task.

WARNING: Disconnect electrical power to the unit before removing the top panel or any electrical panel as the fan motor could start at any time and live electrical connections will be exposed.



10.2 Cabinet Cleaning and Care

Annual cleaning of the exterior cabinet is recommended using a mild detergent, water, and cloth/sponge to remove dust, mold, and potentially corrosive contaminants that have collected on the cabinet. It is also recommended to apply a good quality automotive wax to the painted metal cabinet parts annually to protect the finish and to restore the gloss of the paint. Do not apply wax to the plastic parts.



10.3 Motor Lubrication

The ball bearings in the outdoor motor are pre-lubricated by the motor manufacturer and do not have oiling ports. The motor will run for an indefinite period of time without additional lubrication.



10.4 Replacement Parts

Any replacement part used to replace parts originally supplied on equipment must be the same as or an approved alternate to the original part supplied. The manufacturer will not be responsible for replacement parts not designed to physically fit or operate within the design parameters the original parts were selected for.

11.0 WIRING DIAGRAM

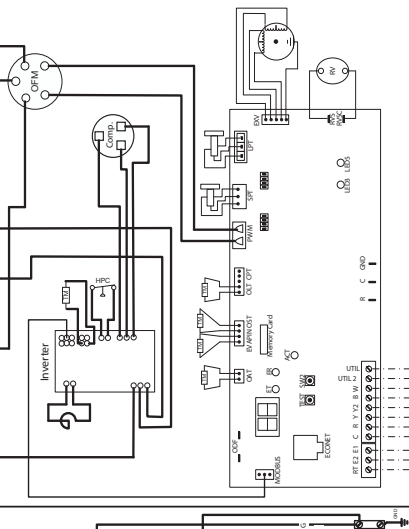
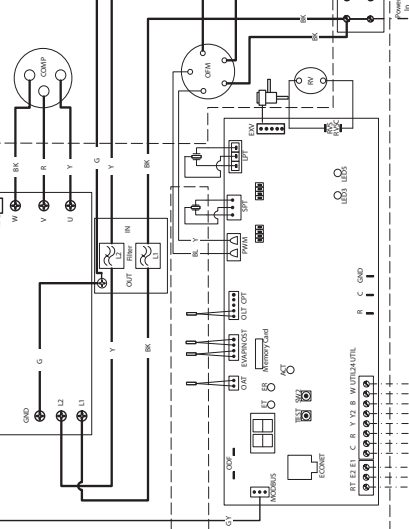
<p>WIRING INFORMATION</p> <p>LINE VOLTAGE -FACTORY STANDARD -FIELD WIRING -FIELD INSTALLED</p> <p>LOW VOLTAGE -FACTORY STANDARD -FIELD INSTALLED -REPLACE WIRE -MUST BE THE SAME SIZE AND TYPE OF INSULATION AS ORIGINAL (105C. MIN.)</p> <p>WARNING -CABINET MUST BE PERMANENTLY GROUNDING AS PER NATIONAL ELECTRICAL CODE, NATIONAL WIRING REGULATIONS, AND LOCAL CODES AS APPLICABLE.</p>	<p>NOTES</p> <ol style="list-style-type: none"> CONNECTORS SUITABLE FOR USE WITH COPPER CONDUCTORS ONLY. COMPRESSOR MOTOR THERMALLY PROTECTED. CONNECT FIELD WIRING IN GROUND RAIN TIGHT CONDUIT TO THE COMPRESSOR. ALL WIRE MUST BE OF THE CORRECT AND PER NATIONAL ELECTRICAL CODES. LOW VOLTAGE CIRCUIT TO BE N.E.C. CLASS 2 WITH CLASS 2 TRANSFORMER 24 VOLT, 50 OR 60 HZ, MIN. 18 AWG. TO THERMOSTAT, REFER TO SYSTEM SCHEMATICS OR SCHEMATICS ON INDOOR SECTION FOR LOW VOLTAGE CONTROL WIRING. SEE DIAGNOSTIC LABEL FOR DISPLAY DIAGNOSTIC CODES. HPC ARE AUTOMATIC RESET SWITCHES. 	<p>WIRE COLOR CODE BK.....BLACK G.....GREEN PR.....PURPLE BR.....BROWN G Y.....GRAY R.....RED BL.....BLUE O.....ORANGE W.....WHITE Y.....YELLOW</p> <p>ELECTRICAL WIRING DIAGRAM</p> <p>VARIABLE SPEED ECONET DEFROST CONTROL (HEAT PUMP) WECM MOTOR</p>  <p>COMPONENT CODES CC.....COMPRESSOR CONTACTOR CFC.....C.C.H.THERMISTOR COMP.....COMPRESSOR COIL.....COIL TEMP EVAP.....EVAPORATOR GND.....GROUND HPC.....HIGH PRESSURE CONTROL LFC.....LOW PRESSURE CONTROL MTR.....MOTOR LED 3.....GREEN LED INVERTER LED 5.....AMBER LED GLOBE LED</p>	<p>SCHEMATIC DIAGRAM</p>  <p>COMPONENT CODES OAT.....OUTDOOR AIR TEMP LPT.....LOAD PRESS. TRANSDUCER SPT.....SUCTION TEMP COIN PTL.....R1 14 COIN TAP SFC.....R150 WIRE COIN RVS.....REVERSING VALVE COIN RVP.....REVERSING VALVE SPT.....SUCTION PRESS. TRANSDUCER MTR.....MOTOR MTR.....24 MFC INPUT LED 5.....AMBER LED GLOBE LED</p>	<p>PART NO.: 90-101229-40 REV: 03</p>
--	--	--	---	---------------------------------------

12.0 APPENDIX



12.1 Agency Performance Audit Test Instructions

Performance audit testing a (-)P20 variable speed heat pump rated combination requires an EcoNet™ Control Center (according to the AHRI rating database) as an accessory to obtain the rated performance. Utilize the following instructions to properly operate the system during audit tests.

1. Install the rated system consistent with this manual and ASHRAE 37.
2. Leak check and charge the rated system per the instructions found in this manual.
3. Wire the outdoor unit, indoor air mover/furnace, indoor coil EXV control (when necessary), and EcoNet™ Control Center according to the following wiring diagrams.

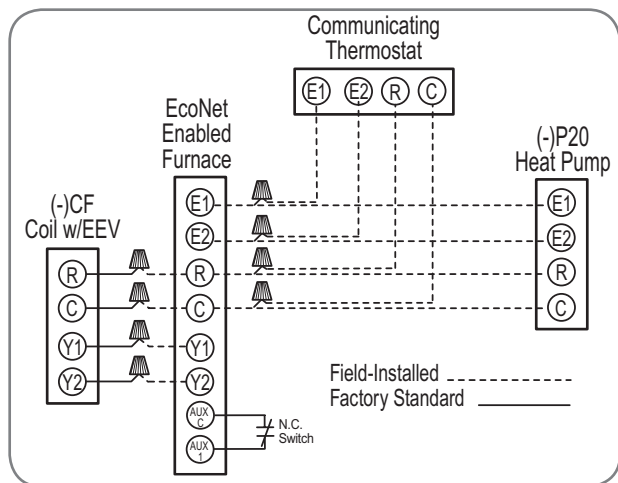
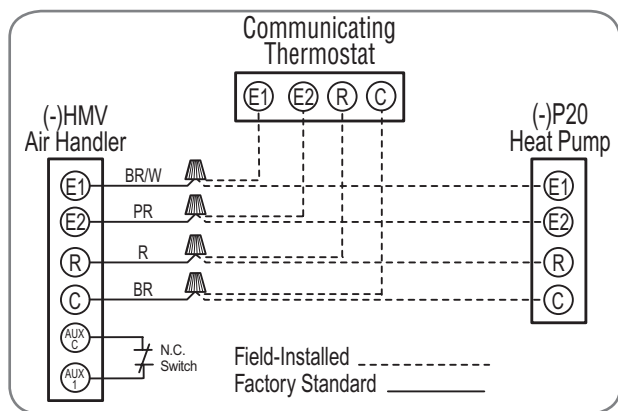

4. Supply high and low voltage to the system.
5. Once each control is powered turn off the Dehumidification feature:
 - a. Pressing the “Settings” button on the home screen followed by pressing the “humidity” button.
 - b. Once in the “humidity” screen, select “Yes” next to the “Enable Dehumidification ?” label.
 - c. To turn dehumidification off press the orange up or blue down arrows once.

- d. The “Yes” should turn to a value of “No.”
6. Once the dehumidification feature is turned off, the Aux 1 configuration needs to be set to normally closed (N.C.) as to permit a closed switch attached to the Aux 1 contacts to keep the system operating. Thereby an open switch would indicate to the system to shut down:
 - a. Press the back arrow in the bottom left of the dehumidification screen to return to the “settings” screen.
 - b. Press the “installer” button in the bottom right corner of the “settings” screen.
 - c. Press the “air handler” or “furnace” button.
 - d. Once in the “air handler settings” or “furnace settings” screen select “N.C.” next to the “Aux Input #1 Config” label.
 - e. Change the “Aux #1 Config” type to “N.C.” by pressing the orange up or blue down arrows at the bottom of the screen twice.
 - f. Select “Off” next to the “Aux Input #1 Config” label.
 - g. Change the “Aux #1 Config” value from “Off” to “Shutdown” by pressing the orange up button at the bottom of the screen two times. After each press of the orange up button the value next to the “Aux #1 Config” label should change.

7. Entering the Test Mode

- a. Press the back arrow in the bottom left of the screen 3 times to return to the home screen showing the inside temperature.
- b. Press the “Service” button on the home screen.
- c. Press the “ODU check-out” button in the bottom right corner of the “service” screen to enter the “installer checkout” screen.
- d. Select the desired mode of operation by pressing “Off” next to the “Var Speed ODU Test” label and then the orange up arrow or blue down arrow at the bottom of the “installer checkout” screen.

NOTE: Any faults must be resolved before the system will start. See the troubleshooting guide in this manual for assistance.

NOTE: If the unit does not start when the “start” button is pushed verify the switch attached to the Aux 1 input on the air handler or furnace control board is closed and no alarms are active.

NOTE: In order to change from heating mode to cooling mode or vice versa the system must first be turned off by pressing the blue down button until “stop test”

12.0 APPENDIX



12.1 Agency Performance Audit Test Instructions (cont.)

appears at the bottom of the “installer checkout” screen. Then press the “Stop” button.

8. Cycle Testing

- a. The Aux #1 configuration performed above permits a N.C. set of contacts to be connected to these terminals on the air handler or the furnace controls.
- b. When performing the optional AHRI cycle tests, the Aux #1 terminals should be used to turn the unit on and off.
- c. When the system is desired to be operating the air handler or furnace control should sense continuity between the Aux #1 and Aux C terminals. This continuity will tell the system to turn on and the Test Mode selection outlined in step 7 above identifies the mode and stage of operation.
- d. When the unit is desired to be off/not operating the air handler or furnace control should sense an open state between the Aux #1 and the Aux C terminals.

9. Exiting the Test Mode

NOTE: While the test mode is active the thermostat will not permit return to the home screen.

- a. To turn the unit off either press the blue down button until “stop test” appears at the bottom of the screen and then press “stop test” on the “installer checkout” screen or open the normally closed switch attached to the air handler or furnace Aux 1 inputs.

NOTE: Once the unit is requested to shut down there is a 4 min. delay during which the test mode cannot be changed.

IMPORTANT: The minimum run and minimum off timers built into the VSODC will be active while operating in the test mode.

- b. Opening the N.C. contact will not exit the test mode, but will permit the system to perform a soft shutdown.
- c. In order for the system to return to normal operating mode press the “Stop” button on the “installer checkout” screen and then press the back arrow in the bottom left hand side of the screen two times. This will return the thermostat to the home screen.