

⚠️WARNING:

RECOGNIZE THIS SYMBOL AS AN INDICATION OF IMPORTANT SAFETY INFORMATION

⚠️WARNING

THESE INSTRUCTIONS ARE INTENDED AS AN AID TO QUALIFIED, LICENSED SERVICE PERSONNEL FOR PROPER INSTALLATION, ADJUSTMENT, AND OPERATION OF THIS UNIT. READ THESE INSTRUCTIONS THOROUGHLY BEFORE ATTEMPTING INSTALLATION OR OPERATION. FAILURE TO FOLLOW THESE INSTRUCTIONS MAY RESULT IN IMPROPER INSTALLATION, ADJUSTMENT, SERVICE, OR MAINTENANCE POSSIBLY RESULTING IN FIRE, ELECTRICAL SHOCK, PROPERTY DAMAGE, PERSONAL INJURY, OR DEATH.

Do not destroy this manual. Please read carefully and keep in a safe place for future reference by a serviceman.

[] indicates metric conversions.

92-105074-04-17 (/) Printed in USA

R-410A HEAT PUMP OUTDOOR UNITS

INSTALLATION INSTRUCTIONS

(-)P14 (14 SEER) AND (-)P15 (15 SEER)

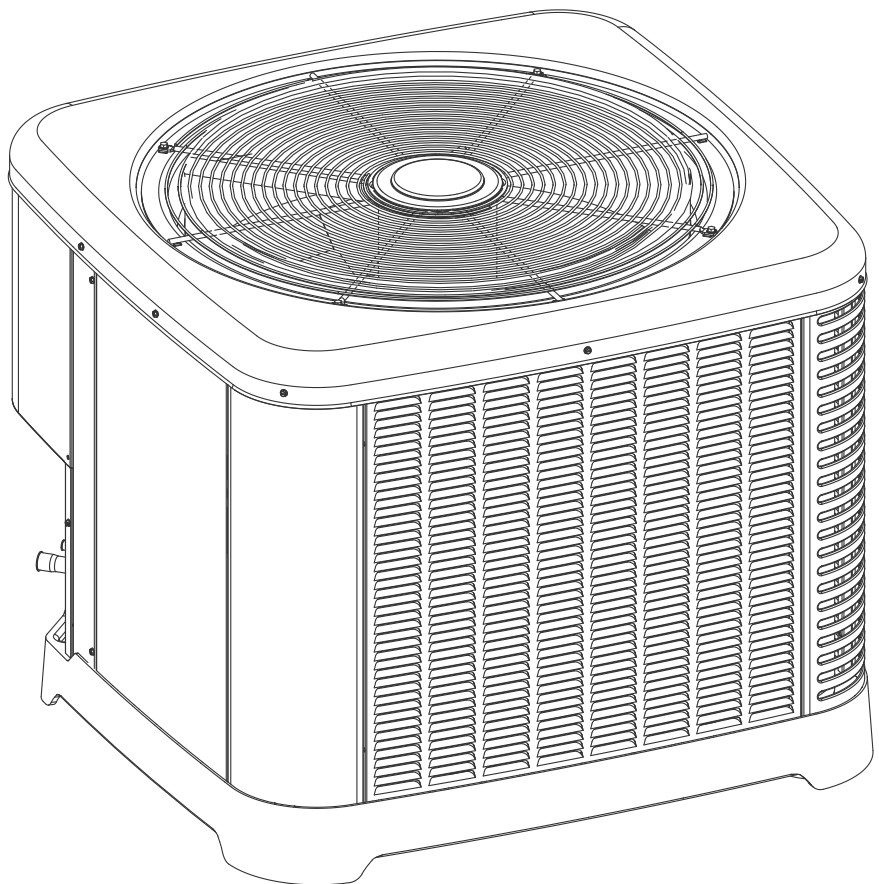

NOTE: Actual unit appearance may vary.



ISO 9001:2008

Certificate Number: 30164



CONTENTS

1.0 IMPORTANT SAFETY INFORMATION	3
2.0 GENERAL INFORMATION	4
2.1 Introduction	4
2.2 Importance of a Quality Installation.....	4
2.3 System Sizing and Selection	4
2.4 Importance of Proper Indoor/Outdoor Match-Ups	5
2.5 Checking Product Received	5
2.6 Efficiency Testing Notice	5
2.7 Compressor Break-In Notice.....	5
3.0 UNIT SPECIFICATIONS	6
3.1 Model Number Nomenclature	6
3.2 Electrical and Physical Data.....	7
4.0 INSTALLATION	9
4.1 Tools & Refrigerant.....	9
4.1.1 Tools Required for Installing & Servicing R-410 Models	9
4.1.2 Specifications of R-410A.....	9
4.1.3 Quick Reference Guide for R-410A	9
4.2 Choosing a Location.....	10
4.2.1 Allowable Clearances	10
4.2.2 Operational Issues Related to Unit Location	10
4.2.3 Corrosive Environments	11
4.2.4 Customer Satisfaction Issues.....	11
4.3 Mounting Unit	11
4.3.1 Unit-Mounting Methods	11
4.3.2 High Wind and Seismic Tie-Down Methods.....	11
4.3.3 Elevating Unit.....	12
4.3.4 Ground Snow Depth Table	12
4.4 Indoor Coil Flow Check Piston: (-)P14**AJP Models Only	14
4.5 Refrigerant Line Set Selection	14
4.5.1 Replacing Existing Systems.....	14
4.5.2 Line Set Length and Fitting Losses	14
4.5.3 Liquid Line Selection.....	14
4.5.4 Vapor Line Selection.....	17
4.5.5 Long Line Length Considerations	17
4.5.5.1 Determining if Long Line Set Length Requirements Apply 17	
4.5.5.2 Oil Return to Compressor.....	17
4.5.5.3 Refrigerant Migration During Off Cycle.....	17
4.5.5.4 Maximum Liquid Pressure Drop	17
4.5.5.5 Liquid Line Refrigerant Flashing	11
4.5.5.6 Compressor Oil Level Adjustment for Long Line Set Applications..	18
4.5.5.7 Capacity Losses.....	18
4.6 Line Set Installation.....	19
4.6.1 Important Tubing Installation Practices.....	19
4.6.2 Relative Location of Indoor and Outdoor Units.....	20
4.6.2.1 Indoor and Outdoor Unit Near Same Level.....	20
4.6.2.2 Outdoor Unit Below Indoor Unit.....	21
4.6.2.3 Outdoor Unit Above Indoor Unit.....	22
4.6.3 Tubing Connections.....	23
4.7 Initial Leak Testing.....	24
4.8 Evacuation	24
4.9 Final Leak Testing	24
4.10 Control Wiring	25
4.11 Typical Control Wiring Diagrams.....	25
4.12 Power Wiring.....	26
4.13 Grounding	26
5.0 SYSTEM START-UP & REFRIGERANT CHARGING	27
5.1 System Start-Up Overview	27
5.2 Initial System Power-Up	27
5.3 Verifying Indoor Air-Flow	27
5.4 Refrigerant Charging	28
5.4.1 Measurement Device Set-Up.....	28
5.4.2 Preliminary Charging by Weight	28
5.4.3 Preliminary Charging by Pressures	29
5.4.4 Final Charging by Liquid Subcooling	29
5.4.5 R-410A Temperature Pressure Chart	30
5.5 Completing Installation	30
6.0 SEQUENCE OF OPERATION	31
6.1 Cooling Mode	31
6.2 Heating Mode.....	31
6.3 Supplemental Electric Heat During Heating Mode	32
6.4 Dual Fuel Applications – Heating Mode	32
6.5 Demand Defrost.....	32
7.0 COMPONENTS & CONTROLS	33
7.1 Demand Defrost Control	33
7.2 Compressor	34
7.3 Fan Motor.....	34
7.4 Outdoor Fan	34
7.5 Compressor Contactor	34
7.6 Compressor/Fan Motor Capacitor	34
7.7 Reversing Valve	34
7.8 Charge Compensator	34
7.9 Thermal Expansion Valve (TXV)	35
7.10 Suction Line Accumulator	35
7.11 High and Low Pressure Controls	36
7.12 Compressor Hard Start Components	36
7.13 Discharge Line Muffler	36
8.0 ACCESSORIES	37
8.1 Compressor Time Delay	37
8.2 Low Ambient Control	37
8.3 Compressor Hard Start Kit	37
8.4 Compressor Crankcase Heater	37
8.5 Heat Pump Thermostat Warning Light	37
8.6 Remote Outdoor Temperature Sensor	37
8.7 Compressor Sound Enclosure	37
9.0 DIAGNOSTICS & TROUBLESHOOTING	38
9.1 Defrost Control Diagnostic Codes	38
9.2 Outdoor Ambient and Coil Sensor Temperature vs. Resistance Table ..	38
9.3 Electrical Checks Flowchart.....	39
9.4 Cooling Mechanical Checks Flowchart.....	40
9.5 Heating Mechanical Checks Flowchart	41
9.6 Defrost Mechanical Checks Flowchart	42
9.7 Defrost Test Mode	42
9.8 General Troubleshooting Guide.....	43
9.9 Service Analyzer Charts.....	44
9.10 Troubleshooting Tips.....	49
10.0 OUTDOOR UNIT MAINTENANCE	50
10.1 Outdoor Coil Cleaning	50
10.2 Cabinet Cleaning and Care	50
10.3 Motor Lubrication	50
10.4 Replacement Parts	50
11.0 WIRING DIAGRAMS	51
11.1 208/230V Single-Phase with PSC Motor	51
11.2 208/230V Single-Phase with ECM Motor	52
11.3 208/230V 3-Phase with PSC Motor.....	53
11.4 208/230V 3-Phase with ECM Motor	54
11.5 460V 3-Phase with PSC Motor	55

1.0 IMPORTANT SAFETY INFORMATION

⚠️ WARNINGS:

- These instructions are intended as an aid to qualified, licensed service personnel for proper installation, adjustment, and operation of this unit. Read these instructions thoroughly before attempting installation or operation. **Failure to follow these instructions may result in improper installation, adjustment, service, or maintenance possibly resulting in fire, electrical shock, property damage, personal injury, or death.**
- **The unit must be permanently grounded. Failure to do so can cause electrical shock resulting in severe personal injury or death.**
- **Turn off electric power at the fuse box or service panel before making any electrical connections.**
- **Complete the ground connection before making line voltage connections. Failure to do so can result in electrical shock, severe personal injury, or death.**
- **Disconnect all power to unit before starting maintenance. Failure to do so can cause electrical shock resulting in severe personal injury or death.**
- **Never assume the unit is properly wired and/or grounded. Always test the unit cabinet with a noncontact voltage detector available at most electrical supply houses or home centers before removing access panels or coming into contact with the unit cabinet.**
- **Do not use oxygen to purge lines or pressurize system for leak test. Oxygen reacts violently with oil, which can cause an explosion resulting in severe personal injury or death.**
- The top of the scroll compressor shell is hot. Touching the compressor top may result in serious personal injury.
- The manufacturer's warranty does not cover any damage or defect to the unit caused by the attachment or use of any components, accessories, or devices (other than those authorized by the manufacturer) into, onto, or in conjunction with the heat pump. **You should be aware that the use of unauthorized components, accessories, or devices may adversely affect the operation of the heat pump and may also endanger life and property.** The manufacturer disclaims any responsibility for such loss or injury resulting from the use of such unauthorized components, accessories, or devices.

⚠️ CAUTIONS:

- R-410A systems operate at approximately 60% higher pressures (1.6 times) than R-22 systems. Do not use R-22 service equipment or components on R-410A equipment. Use appropriate care when using this refrigerant. Failure to exercise care may result in equipment damage or personal injury.
- Only match this outdoor unit with a matched indoor coil or air handler approved for use with this outdoor unit per the unit manufacturer's specification sheet. The use of unmatched coils or air handler will likely result in a charge imbalance between the cooling and heating modes which can cause unsatisfactory operation including a high-pressure switch lockout condition.
- Only use indoor coils approved for use on R-410A systems. An R-22 coil will have a TXV or fixed restrictor device that is not designed to operate properly in an R-410A system and will result in serious operational issues. The R-22 coil could also contain mineral oil which is incompatible with the POE oil used in R-410A systems and could result in reliability issues with the compressor and TXVs.
- When coil is installed over a finished ceiling and/or living area, it is required that a secondary sheet metal condensate pan be constructed and installed under the entire unit. Failure to do so can result in property damage.
- The compressor has an internal overload protector. Under some conditions, it can take up to 2 hours for this overload to reset. Make sure overload has had time to reset before condemning the compressor.
- **UNIT MAY START SUDDENLY AND WITHOUT WARNING.** A flashing red light on the heat pump/defrost control indicates a call for unit operation is present at the heat pump/defrost control. The heat pump/defrost control will attempt to start unit after the anti-short cycle time expires, when a high or low pressure control automatically resets, or when the heat pump/defrost control exits the lockout mode as the temperature rises above 5°F [-15°C].

⚠️ WARNING:

Single-pole contactors are used on all standard single-phase units through 5 tons. Caution must be exercised when servicing as only one leg of the power supply is broken by the contactor.

2.0 GENERAL INFORMATION

⚠WARNING:

Improper installation, or installation not made in accordance with these instructions, can result in unsatisfactory operation and/or dangerous conditions and can cause the related warranty not to apply.

2.1 Introduction

The information contained in this manual has been prepared to assist in the proper installation, operation, and maintenance of the air conditioning system.

Read this manual and any instructions packaged with separate equipment required to make up the system prior to installation. Homeowner should retain this manual for future reference.

2.2 Importance of Quality Installation

A quality installation is critical to assure safety, reliability, comfort, and customer satisfaction. Strict adherence to applicable codes, the information in this installation manual, the outdoor unit installation manual, and the thermostat installation manual are key to a quality installation. Read the entire instruction manuals before starting the installation.

IMPORTANT: This product has been designed and manufactured to meet certified AHRI capacity and efficiency ratings with the appropriate outdoor units. However, proper refrigerant charge, proper airflow, and refrigerant line sizing are critical to achieve optimum capacity and efficiency and to assure reliable operation. Installation of this product should follow the manufacturer's refrigerant charging and airflow instructions located in this installation manual and the charging chart label affixed to the outdoor unit. Failure to confirm proper charge and airflow may reduce energy efficiency and shorten equipment life.

The equipment has been evaluated in accordance with the Code of Federal Regulations, Chapter XX, Part 3280.

Install the unit in accordance with applicable national, state, and local codes. Latest editions are available from: "National Fire Protection Association, Inc., Batterymarch Park, Quincy, MA 02269." These publications are:

- ANSI/NFPA No. 70-(Latest Edition) National Electrical Code.

- NFPA90A Installation of Air Conditioning and Ventilating Systems.

- NFPA90B Installation of warm air heating and air conditioning systems.

Install the indoor unit in such a way as to allow necessary access to the coil/filter rack and blower/control compartment.

2.3 System Sizing and Selection

Before specifying any heat pump equipment, a survey of the structure and a heat loss and heat gain calculation must be made. A heat loss calculation involves identifying all surfaces and openings that lose heat to the surrounding air and quantifying that heat loss. A cooling heat gain calculation makes similar measurements and determines the amount of heat needed to be removed. A heat gain calculation also calculates the extra heat load caused by sunlight and by humidity removal. These factors must be considered before selecting a heat pump system to provide year-round comfort. The Air Conditioning Contractors of America (ACCA) Manual J method of load calculation is one recognized procedure for determining the heating and cooling load.

After the proper equipment combination has been selected, satisfying both sensible and latent requirements, the system must be properly installed. Only then can the system provide the comfort it was designed to provide.

There are several factors that installers must consider.

- Outdoor unit location
- Indoor unit blower speed and airflow
- Proper equipment evacuation
- Supply and return air duct design and sizing
- Refrigerant charge
- System air balancing
- Diffuser and return air grille location and sizing

IMPORTANT: Excessive use of elbows in the refrigerant line set can produce excessive pressure drop. Follow industry best practices for installation. Installation and commissioning of this equipment is to be performed by trained and qualified HVAC professionals. For technical assistance, contact your Distributor Service Coordinator.

2.0 GENERAL INFORMATION

2.4 Importance of Proper Indoor/Outdoor Match-Ups

To assure many years of reliable operation and optimum customer comfort and to assure the outdoor unit warranty remains valid, an air-handler model or indoor coil/furnace combination should be selected that is properly matched to the outdoor unit. This is especially critical for heat pump systems to assure proper refrigerant charge balance between the cooling and heating modes. The recommended approach is to select an air-handler or indoor coil and gas furnace that has an AHRI match with the outdoor unit. Refer to the AHRI directory at www.ahridirectory.org to confirm the air-handler and outdoor unit are a certified combination in the AHRI Directory.

2.5 Checking Product Received

Upon receiving unit, inspect it for any shipping damage. Claims for damage, either apparent or concealed, should be filed immediately with the shipping company. Check model number, electrical characteristics, and accessories to determine if they are correct. Check system components (indoor coil, outdoor unit, air handler/furnace, etc.) to make sure they are properly matched.

2.6 Efficiency Testing Notice

For purposes of verifying or testing efficiency ratings, the test procedure in Title 10 APPENDIX M to Subpart B of Part 430 (Uniform Test Method for Measuring the Energy Consumption of Central Air Conditioners and Heat Pumps) and the clarifying provisions provided in the AHRI Operations Manual 210/240 that were applicable at the date of manufacture should be used for test set up and performance.

2.7 Compressor Break-In Notice

Prior to performance audit testing, system must be operated for 20 hours at 115°F [46.1°C] outdoor ambient temperature with 80°F [26.7°C] dry bulb/75°F [23.9°C] wet bulb indoor ambient temperature to break in the compressor.

3.0 UNIT SPECIFICATIONS

3.1 Model Number Nomenclature

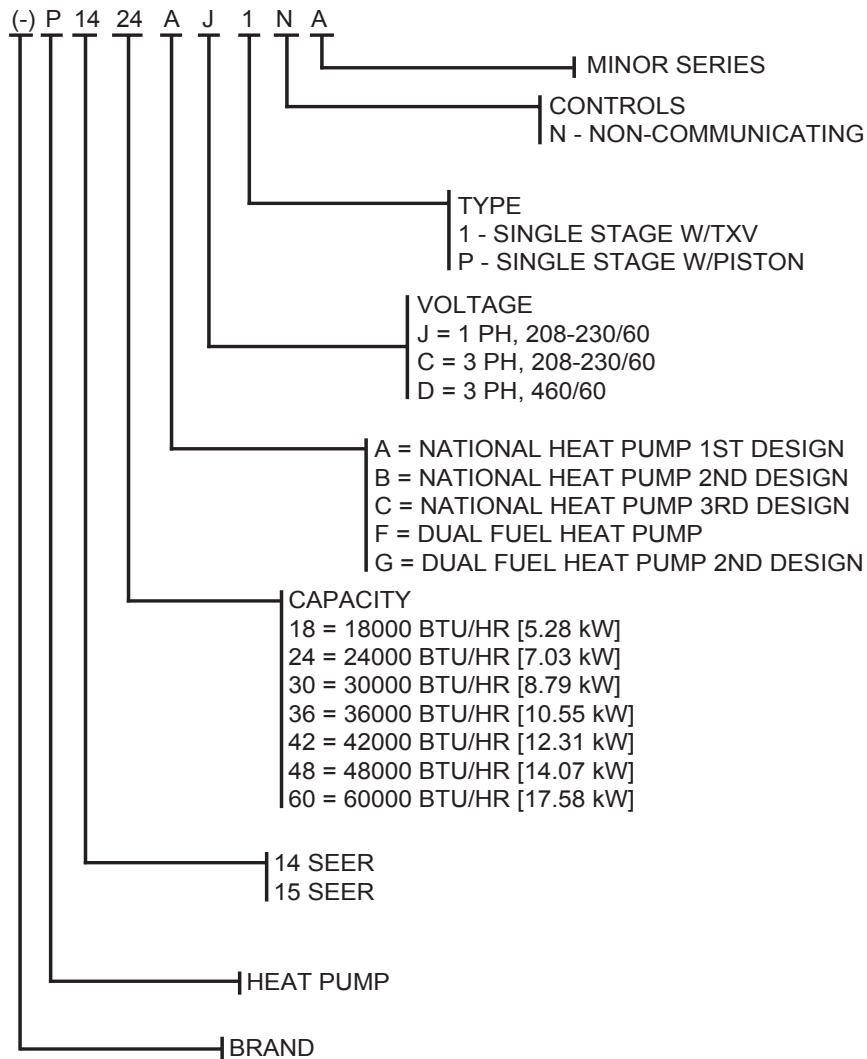

3.2 Available Models

(-)P1418CJ1NA	(-)P1518CJ1NA	(-)P1418GJ1NA	(-)P1418AJPNA
(-)P1424AJ1NA	(-)P1524BJ1NA	(-)P1424FJ1NA	(-)P1424AJPNA
(-)P1430AJ1NA	(-)P1530BJ1NA	(-)P1430FJ1NA	(-)P1430AJPNA
(-)P1436AJ1NA	(-)P1536AJ1NA	(-)P1436FJ1NA	(-)P1436AJPNA
(-)P1436AC1NA	(-)P1536AC1NA	(-)P1436FC1NA	(-)P1436BJPNA
(-)P1436AD1NA	(-)P1542AJ1NA	(-)P1442FJ1NA	(-)P1442AJPNA
(-)P1442CJ1NA	(-)P1542AC1NA	(-)P1442FC1NA	(-)P1448AJPNA
(-)P1442CC1NA	(-)P1542BJ1NA	(-)P1442GJ1NA	(-)P1460AJPNA
(-)P1442CD1NA	(-)P1542BC1NA	(-)P1442GC1NA	
(-)P1448AJ1NA	(-)P1548AJ1NA	(-)P1448FJ1NA	
(-)P1448AC1NA	(-)P1548AC1NA	(-)P1448FC1NA	
(-)P1448AD1NA	(-)P1560AJ1NA	(-)P1460FJ1NA	
(-)P1460BJ1NA	(-)P1560AC1NA	(-)P1460FC1NA	
(-)P1460BC1NA			
(-)P1460AD1NA			

3.0 UNIT SPECIFICATIONS



3.3 Electrical and Physical Data (cont.)

DIMENSIONS

(-)P14	18C, 24A, 30A, 18G, 24F	18AJP, 24AJP, 36A	30F 30AJP	42AJP, 42C, 36F, 42F, 48A	42G, 48F	60B, 48AJP, 60F	36AJP, 36BJP	60AJP
Height "H" inches (mm)	25 (635)	27 (686)	31 (787)	35 (889)	39 (991)	45 (1143)	39 (991)	51 (1295)
Length "L" inches (mm)	29.75 (756)	33.75 (857)	33.75 (857)	33.75 (857)	35.75 (908)	35.75 (908)	33.75 (857)	35.75 (908)
Width "W" inches (mm)	29.75 (756)	33.75 (857)	33.75 (857)	33.75 (857)	35.75 (908)	35.75 (908)	33.75 (857)	35.75 (908)

(-)P15	18, 24	30	36, 42A	42B, 48	60
Height "H" inches (mm)	25 (635)	31 (787)	35 (889)	39 (991)	45 (1143)
Length "L" inches (mm)	29.75 (756)	33.75 (857)	33.75 (857)	35.75 (908)	35.75 (908)
Width "W" inches (mm)	29.75 (756)	33.75 (857)	33.75 (857)	35.75 (908)	35.75 (908)

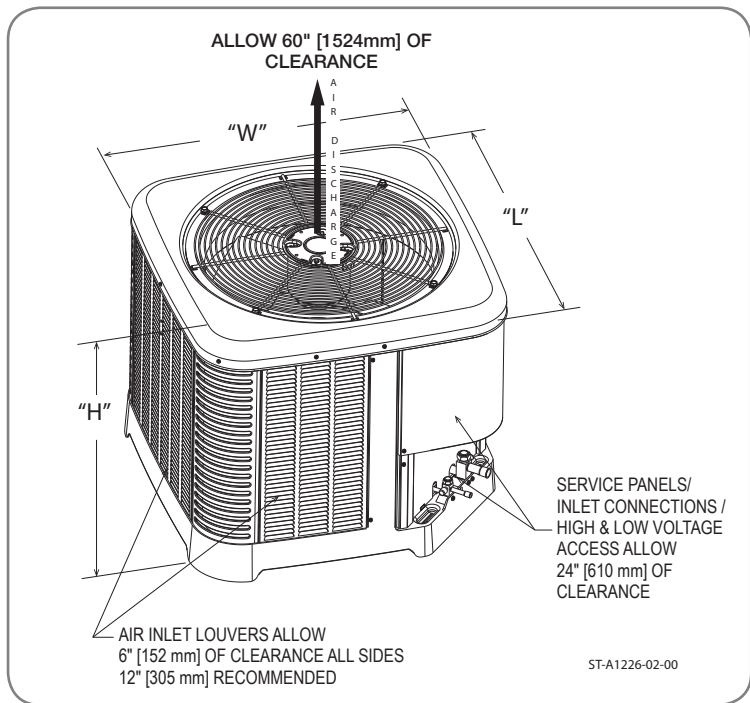

NOTE: Actual unit appearance may vary.

4.0 INSTALLATION



4.1 Tools and Refrigerant

4.1.1 Tools Required for Installing and Servicing R-410A Models

Manifold Sets:

- Up to 800 PSIG High-Side
- Up to 250 PSIG Low-Side
- 550 PSIG Low-Side Retard

Manifold Hoses:

- Service Pressure Rating of 800 PSIG

Recovery Cylinders:

- 400 PSIG Pressure Rating
- Dept. of Transportation 4BA400 or BW400

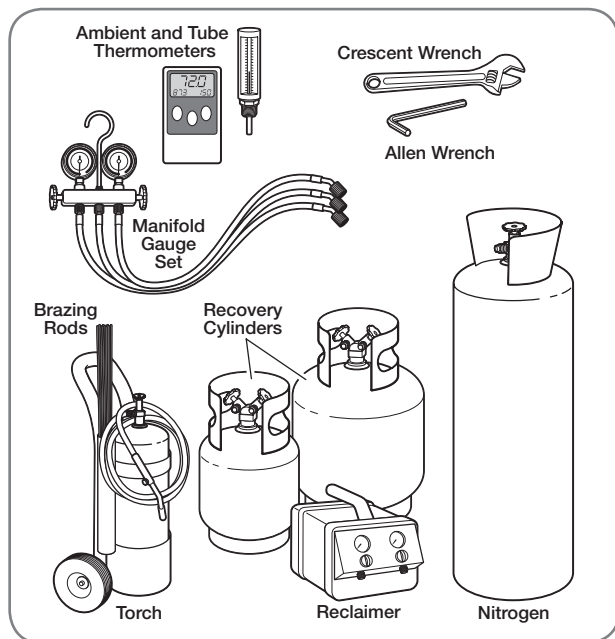

CAUTION: R-410A systems operate at higher pressures than R-22 systems. Do not use R-22 service equipment or components on R-410A equipment.

4.1.2 Specifications of R-410A

Application: R-410A is not a drop-in replacement for R-22. Equipment designs must accommodate its higher pressures. It cannot be retrofitted into R-22 heat pumps.

Physical Properties: R-410A has an atmospheric boiling point of -62.9°F [-52.7°C] and its saturation pressure at 77°F [25°C] is 224.5 psig.

Composition: R-410A is a near-azeotropic mixture of 50% by weight difluoromethane (HFC-32) and 50% by weight pentafluoroethane (HFC-125).

Pressure: The pressure of R-410A is approximately 60% (1.6 times) greater than R-22. Recovery and recycle equipment, pumps, hoses, and the like must have design pressure ratings appropriate for R-410A. *Manifold sets need to range up to 800 psig high-side and 250 psig low-side with a 550 psig low-side retard. Hoses need to have a service pressure rating of 800 psig. Recovery cylinders need to have a 400 psig service pressure rating, DOT 4BA400 or DOT BW400.*

Combustibility: At pressures above 1 atmosphere, a mixture of R-410A and air can become combustible. **R-410A and air should never be mixed in tanks or supply lines or be allowed to accumulate in storage tanks. Leak checking should never be done with a mixture of R-410A and air.** Leak-checking can be performed safely with nitrogen or a mixture of R-410A and nitrogen.

4.1.3 Quick-Reference Guide for R-410A

- R-410A refrigerant operates at approximately 60% higher pressure (1.6 times) than R-22. Ensure that servicing equipment is designed to operate with R-410A.
- R-410A refrigerant cylinders are light rose in color.
- R-410A, as with other HFCs, is only compatible with POE oils.
- Vacuum pumps will not remove moisture from POE oil used in R-410A systems.
- R-410A systems are to be charged with liquid refrigerants. Prior to March 1999, R-410A refrigerant cylinders had a dip tube. These cylinders should be kept upright for equipment charging. Post-March 1999 cylinders do not have a dip tube and should be inverted to ensure liquid charging of the equipment.
- Do not install a suction line filter drier in the liquid line.
- A factory-approved bi-flow liquid line filter drier is shipped with every unit and must be installed in the liquid line at the time of installation. Only manufacturer-approved liquid line filter driers should be used. Filter driers must have a maximum working pressure rating of at least 600 psig. The filter drier will only have adequate moisture-holding capacity if the system is properly evacuated.
- Desiccant (drying agent) must be compatible for POE oils and R-410A refrigerant.

4.0 INSTALLATION



4.2 Choosing a Location

4.2.1 Allowable Clearances

- 12" to side intake louvers
- 24" to service access panels
- 60" vertical for fan discharge

If space limitations exist, the following clearances will have minimal impact to capacity and efficiency and are permitted:

Single-Unit Applications: Minimum of 6" to side intake louvers. Do not reduce the 60" [152.4 cm] for fan discharge or the 24" [61.0 cm] service clearances.

Multiple-Unit Applications: For units positioned next to each other, a minimum of 6" [15.2 cm] clearance between units is recommended for 1.5 and 2 ton models and 9" [22.9 cm] for 2.5 ton to 5 ton models. Do not reduce the 60" [152.4 cm] for fan discharge or the 24" [61.0 cm] service clearances.

IMPORTANT: Consult local and national building codes and ordinances for special installation requirements. Following location information will provide longer life and simplified servicing of the outdoor heat pump.

NOTICE: These units must be installed outdoors. No ductwork can be attached, or other modifications made, to the discharge grille. Modifications will affect performance or operation.

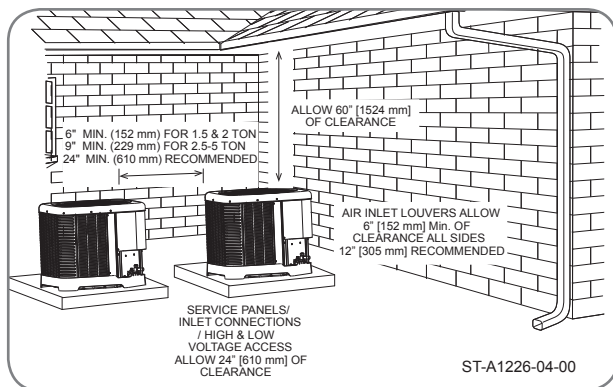

4.2.2 Operational Issues Related to Unit Location

IMPORTANT: Locate the unit in a manner that will not prevent, impair, or compromise the performance of other equipment installed in proximity to the unit. Maintain all required minimum distances to gas and electric meters, dryer vents, and exhaust and inlet openings. In the absence of national codes or manufacturers' recommendations, local code recommendations and requirements will take precedence.

- Refrigerant piping and wiring should be properly sized and kept as short as possible to avoid capacity losses and increased operating costs.
- Locate the unit where water runoff will not create a problem with the equipment. Position the unit away from the drip edge of the roof whenever possible. Units are weatherized, but can be affected by the following:
 - Water pouring into the unit from the junction of rooflines, without protective guttering. Large volumes of water entering the heat pump while in operation can impact fan blade or motor life, and coil damage may occur to a heat pump if moisture cannot drain from the unit under freezing conditions.
 - Freezing moisture or sleeting conditions can cause the cabinet to ice-over prematurely and prevent heat pump operation, requiring backup heat, which generally results in less economical operation. It is highly recommended to switch the EcoNet™ Control Center or thermostat to the "Emergency Heat" mode during freezing rain or sleeting conditions to prevent damage to the outdoor coil from ice accumulating on the fan blade.
- Closely follow the clearance recommendations in section 4.2.1.
 - 24" [61.0 cm] to the service panel access
 - 60" [152.4 cm] above heat pump fan discharge (unit top) to prevent recirculation
 - 6" [15.2 cm] to heat pump coil grille air inlets with 12" [30.5 cm] minimum recommended

4.0 INSTALLATION



4.2 Choosing a Location (cont.)

4.2.3 Corrosive Environment

The metal parts of this unit may be subject to rust or deterioration if exposed to a corrosive environment. This oxidation could shorten the equipment's useful life.

Corrosive elements include, but are not limited to, salt spray, fog or mist in seacoast areas, sulphur or chlorine from lawn watering systems, and various chemical contaminants from industries such as paper mills and petroleum refineries.

If the unit is to be installed in an area where contaminants are likely to be a problem, special attention should be given to the equipment location and exposure.

- Avoid having lawn sprinkler heads spray directly on the unit cabinet.
- In coastal areas, locate the unit on the side of the building away from the waterfront.
- Shielding provided by a fence or shrubs may give some protection, but cannot violate minimum airflow and service access clearances.

⚠ WARNING: Disconnect all power to unit before starting maintenance. Failure to do so can cause electrical shock resulting in severe personal injury or death.

Regular maintenance will reduce the buildup of contaminants and help to protect the unit's finish.

- Frequent washing of the cabinet, fan blade, and coil with fresh water will remove most of the salt or other contaminants that build up on the unit.
- Regular cleaning and waxing of the cabinet with a good automobile polish will provide some protection.
- A good liquid cleaner may be used several times a year to remove matter that will not wash off with water.

4.2.4 Customer Satisfaction Issues

- The heat pump should be located away from the living, sleeping, and recreational spaces of the owner and those spaces on adjoining property.
- To prevent noise transmission, the mounting pad for the outdoor unit should not be connected to the structure and should be located a sufficient distance above grade to prevent ground water from entering the unit.



4.3 Mounting Unit

4.3.1 Unit Mounting Methods

The outdoor heat pump unit may be mounted in a number of ways. The most common method is on a ground mounted concrete or pre-fabricated pad. It can also be mounted on a ground or roof mounted metal frame, wooden frame, or 4" x 4" wooden stringers. It is extremely important to properly secure the unit to the pad or frame so it does not shift during high winds, seismic events, or other outside forces to eliminate the possibility of a safety hazard or physical damage to the unit. Local codes in regions subject to frequent hurricanes and seismic events will dictate specific mounting requirements and must be followed. It is also important to elevate the heat pump in areas that receive a significant amount of snowfall so accumulated snow does not block the outdoor coil and interfere with drainage of water during the defrost cycle. Refer to Section 4.3.4 for typical ground snow levels for different regions of the USA.

4.3.2 High Wind and Seismic Tie-Down Methods

The manufacturer-approved/recommended method is a guide to securing equipment for wind and seismic loads. Other methods might provide the same result, but the manufacturer method is the only one endorsed by the manufacturer for securing equipment where wind or earthquake damage can occur. Additional information is available on the manufacturer's website or from the wholesale distributor.

4.0 INSTALLATION

4.3.3 Elevating Unit

⚠ WARNING: Secure an elevated unit and its elevating stand in order to prevent tipping. Failure to do so may result in severe personal injury or death.

If elevating the heat pump, either on a flat roof or on a slab, observe the following guidelines.

- The bottom of the basepan has receptacles for 4" [10.2 cm] schedule 40 PVC pipe that can be cut to length and used as risers for slab applications.
- If elevating a unit on a flat roof, use 4" x 4" [10.2 cm x 10.2 cm] or equivalent stringers positioned to distribute unit weight evenly and prevent noise and vibration.
- Where snowfall is anticipated, raise the unit above the base pad to prevent ice buildup and coil damage. Mount the unit high enough to be above the average accumulated area snowfall. See "Ground Snow Depth" chart below for representative snow depths.

NOTICE: Do not block drain openings on bottom of unit.

- If unit must be elevated because of anticipated snowfall, secure unit and elevating stand such that unit and/or stand will not tip over or fall off. Keep in mind that someone may try to climb on unit.

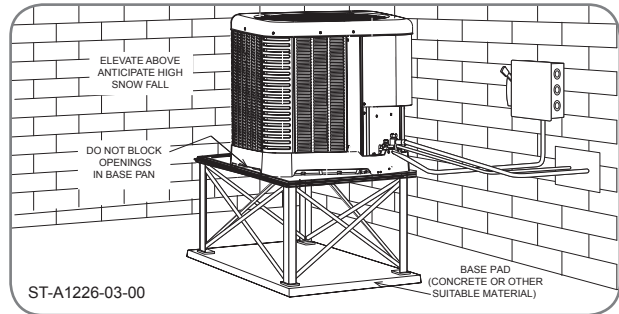

4.3.4 Ground Snow Depth Table

GROUND SNOW DEPTH - INCHES

ALABAMA		INDIANA		MINNESOTA		NEW MEXICO		PENNSYLVANIA		VIRGINIA	
Huntsville	7	Evansville	12	Duluth	64	Albuquerque	4	Allentown	23	Dulles Airport	19
ARIZONA		Fort Wayne	17	International Falls	43	Clayton	10	Erie	19	Lynchburg	16
Flagstaff	48	Indianapolis	21	Minneapolis/St. Paul	50	Roswell	8	Harrisburg	23	National Airport	18
Prescott	3	South Bend	44	Rochester	50	NEW YORK		Philadelphia	16	Norfolk	9
Winslow	7	IOWA		St. Cloud	53	Albany	25	Pittsburgh	22	Richmond	12
ARKANSAS		Burlington	17	MISSISSIPPI		Binghamton	35	Scranton	16	Roanoke	17
Fort Smith	5	Des Moines	22	Jackson	3	Buffalo	42	Williamsport	20	WASHINGTON	
Little Rock	6	Dubuque	38	MISSOURI		NYC - Kennedy Airport	18	Providence	21	Olympia	24
CALIFORNIA		Sioux City	33	Columbia	21	NYC - LaGuardia Airport	18	South Carolina	21	Quillayute	24
Blue Canyon	25	Waterloo	36	Kansas City	18	Rochester	38	Columbia	12	Seattle-Tacoma	14
Mt. Shasta	69	KANSAS		St. Louis	16	Syracuse	35	Greenville	4	Stampede Pass	51
COLORADO		Concordia	23	Springfield	14	NORTH CAROLINA		Aberdeen	42	Yakima	25
Alamosa	15	Dodge City	12	MONTANA		Asheville	12	Huron	43	WEST VIRGINIA	
Colorado Springs	14	Goodland	14	Billings	17	Cape Hattaras	5	Rapid City	14	Beckley	51
Denver	15	Topeka	19	Glasgow	17	Charlotte	10	Sioux Falls	38	Charleston	20
Grand Junction	16	Wichita	11	Great Falls	16	Greensboro	11	Huntington	15	Elkins	21
Pueblo	7	KENTUCKY		Havre	24	Raleigh-Durham	10	Chattanooga	6	Green Bay	36
CONNECTICUT		Covington	12	Helena	18	Wilmington	9	Knoxville	8	La Crosse	32
Bridgeport	23	Lexington	12	Kalispell	53	Winston-Salem	17	Memphis	5	Madison	32
Hartford	29	Louisville	11	Missoula	23	NORTH DAKOTA		Nashville	8	Madison	32
New Haven	15	MAINE		Norfolk	29	Bismarck	25	Chattanooga	6	Milwaukee	32
DELAWARE		Caribou	100	Grand Island	30	Fargo	34	Chattanooga	6	WYOMING	
Wilmington	13	Portland	62	Lincoln	20	Williston	25	Knoxville	8	Casper	10
GEORGIA		MARYLAND		Norfolk	29	OHIO		Chattanooga	6	Cheyenne	15
Athens	5	Baltimore	17	North Platte	15	Akron-Canton	15	Chattanooga	6	Lander	20
Macon	8	MASSACHUSETTS		Omaha	20	Cleveland	16	Chattanooga	6	Sheridan	25
IDAHO		Boston	30	Scottsbluff	11	Columbus	10	Chattanooga	6		
Boise	6	Nantucket	18	Valentine	22	Dayton	11	Chattanooga	6		
Lewiston	9	Worcester	35	NEVADA		Mansfield	17	Chattanooga	6		
Pocatello	7	MICHIGAN		Elko	20	Toledo Express	8	Chattanooga	6		
ILLINOIS		Alpena	53	Ely	9	Youngstown	12	Chattanooga	6		
Chicago O'Hare	18	Detroit City	9	Reno	11	OKLAHOMA		Chattanooga	6		
Chicago	22	Detroit Airport	17	Winnemucca	6	Oklahoma City	5	Chattanooga	6		
Moline	17	Detroit - Willow Run	21	NEW HAMPSHIRE		Tulsa	8	Chattanooga	6		
Peoria	16	Flint	28	Concord	66	OREGON		Chattanooga	6		
Rockford	25	Grand Rapids	37	NEW JERSEY		Burns City	24	Chattanooga	6		
Springfield	23	Houghton Lake	56	Atlantic City	11	Eugene	17	Chattanooga	6		
		Lansing	42	Newark	15	Medford	8	Chattanooga	6		
		Marquette	53			Pendleton	11	Chattanooga	6		
		Muskegon	43			Portland	10	Chattanooga	6		
		Sault Ste. Marie	80			Salem	7	Chattanooga	6		

NOTICE: Local records and experience must be considered when establishing the unit installation height. There is a 2% probability that the ground snow depth shown in this table will be exceeded annually. Drifts have not been considered. This data represents 184 National Weather Service locations at which measurements are made and assumes a nationwide snow density of 12 lb./ft.³

4.0 INSTALLATION



4.4 Indoor Coil Flow Check Piston: (-)P14**AJP Models Only

NOTICE: For proper system operation, it may be necessary to replace the piston installed in the indoor coil. Check the service valves on this unit to see if a notice tag along with a plastic bag containing a piston is attached. If one is present a change of the piston is required. Failure to change the piston can result in improper performance of the system.

The flow check piston is a multi-purpose device. With flow into the compression nut end from the liquid line, the piston is in a check position and acts as the expansion device with flow through the metering orifice in the center of the piston. The "O" ring on the end of the piston prevents refrigerant from bypassing the metering orifice. Flow from the metering orifice is centered into a distributor which serves to evenly distribute refrigerant to the evaporator circuits. With flow in the reverse direction (direction of arrows on the distributor body), the piston is forced off the seat and liquid from the condenser is allowed to free flow around the piston.

It is essential that the heat pump indoor and outdoor sections be properly matched. Use only matched components as shown in sales specification sheets.

A piston size that is too small will cause refrigerant starving and one that is too large will cause refrigerant flooding. In either case, system performance, reliability and charge balance (heating and cooling) will be unacceptable.

Change the piston in the distributor on the indoor coil before installing the coil and charging the system following the procedure below:

- Using a back-up wrench on the distributor body, loosen the compression nut to gain access to the piston.

HEAT PUMP OUTDOOR UNIT	PISTON SIZE INDOOR COIL
(-)P1418AJP	49
(-)P1424AJP	57
(-)P1430AJP	62
(-)P1436AJP	67
(-)P1442AJP	74
(-)P1448AJP	78

- Using the wire provided with replacement pistons, run (hooked end) through hole in piston.
- Hook nose end of piston and lift gently from distributor body.
- Replace piston with one of proper size (see table below), install piston with gasket end of piston in distributor. Do not force piston into distributor.
- NOTE: With piston in distributor, seal end should be down and should not be seen looking in end of distributor. Piston must be free to rotate and move up and down. Make sure piston is free to move in distributor body.
- Ensure distributor gasket is located properly in the distributor body.
- Replace compression nut using back-up wrench on distributor body. Torque compression nut end with 8 to 10 ft. lbs. [10.3 to 13.6 Nm]
- Original piston size is stamped on outside of distributor body. Remove new piston size label from poly bag new piston came in and install new size label on outside of distributor tube.
- Check fittings for leaks after installation, evacuation and charging is complete.

IMPORTANT: Do not attempt to drill pistons to size in the field. Metering holes have a special chamfered inlet and cannot be modified.

IMPORTANT: Do not replace the neoprene "O" ring on the piston with any type of seal. Contact the parts department for the exact replacement of "O" ring.

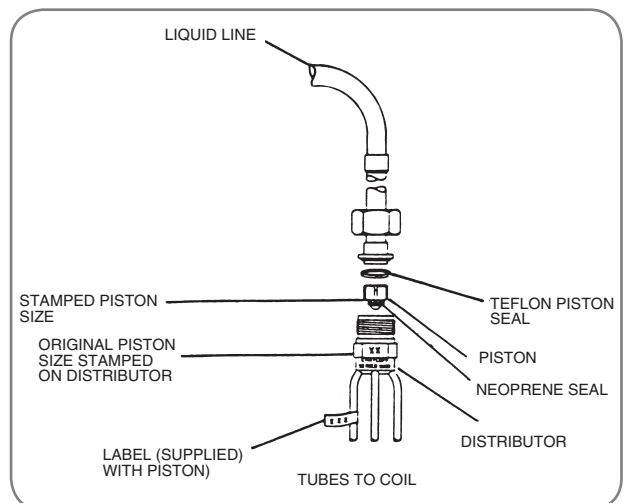

Installation

4.0 INSTALLATION



4.5 Refrigerant Line Set Selection

4.5.1 Replacing Existing Systems

To prevent failure of a new unit, the existing line set must be correctly sized for the new unit and must be cleaned or replaced. Care must be taken so the expansion device is not plugged. For new and replacement units, a liquid line filter drier must be installed and the line set must be properly sized. Test the oil for acid. If it tests positive for acid, a suction line filter drier is mandatory.

IMPORTANT: When replacing an R-22 unit with an R-410A unit, either replace the line set or ensure that residual mineral oil is drained from existing lines including oil trapped in low spots.

4.5.2 Line Set Length and Fitting Losses

Refrigerant tubing is measured in terms of actual length and equivalent length. Actual length is used for refrigerant charge applications. Equivalent length takes into account pressure losses from

tubing length, fittings, vertical separation, accessories, and filter driers. The table below references commonly used equivalent lengths.

Table 1

Equivalent Length for Fittings (ft) [m]							
Line Size (in) [mm]	90° Short Radius Elbow	90° Long Radius Elbow	45° Elbow	Solenoid Valve	Check Valve	Site Glass	Filter Drier
3/8 [9.53]	1.3 [0.40]	0.8 [0.24]	0.3 [0.09]	6 [1.83]	4 [1.22]	0.4 [0.12]	6 [1.83]
1/2 [12.71]	1.4 [0.43]	0.9 [0.27]	0.4 [0.12]	9 [2.74]	5 [1.52]	0.6 [0.18]	6 [1.83]
5/8 [15.88]	1.5 [0.46]	1 [0.30]	0.5 [0.15]	12 [3.66]	6 [1.83]	0.8 [0.24]	6 [1.83]
3/4 [19.05]	1.9 [0.58]	1.3 [0.40]	0.6 [0.18]	14 [4.27]	7 [2.13]	0.9 [0.27]	6 [1.83]
7/8 [22.23]	2.3 [0.70]	1.5 [0.46]	0.7 [0.21]	15 [4.57]	8 [2.44]	1 [0.30]	6 [1.83]
1-1/8 [28.58]	2.7 [0.82]	1.8 [0.55]	0.9 [0.27]	22 [6.71]	12 [3.66]	1.5 [0.46]	6 [1.83]

4.5.3 Liquid Line Selection

The purpose of the liquid line is to transport warm sub-cooled liquid refrigerant between the outdoor unit to the indoor unit. It is important not to allow the refrigerant to flash into superheated vapor prior to the expansion device of the indoor or outdoor coil. The flashing of refrigerant can occur for the following reasons:

- Low refrigerant charge
- Improperly selected liquid line size
- Absorption of heat prior to expansion device
- Excessive vertical separation between the outdoor unit and indoor coil
- Restricted liquid line or filter drier
- Kinked liquid line

Table 2 lists the equivalent length per 25' of liquid line at various diameters up to 250' [76 m]. The total pressure drop allowed for the liquid line is 50 PSI [345 kPa]. The procedure for selecting the proper liquid line is as follows:

- Measure the total amount of vertical separation between the outdoor unit and indoor coil.
- Measure the linear length of liquid line needed.
- Add all of the equivalent lengths associated with any fittings or accessories using Table 1 above.
- Add the linear length to the total fitting equivalent length. This will equal your total equivalent line length.
- Reference Table 2 to verify the calculated equivalent length is acceptable with the required vertical separation and diameter of liquid line.

4.0 INSTALLATION



4.5 Refrigerant Line Set Selection (cont.)

Table 2A: Refrigerant Line Sizing Chart (English Units)

14 - 15 SEER Single-Stage Heat Pumps																	
Unit Size	Allowable Liquid Line Size	Allowable Vapor Line Size	Use Long Line Guidelines for Linear Lines Length Greater Than Shown Below (Feet)			Outdoor Unit ABOVE or BELOW Indoor Unit											
						Equivalent Length (Feet)											
			< 25	26-50	51-75	76-100	101-125	126-150	151-175	176-200	201-225	226-250	Maximum Vertical Separation / Capacity Multiplier				
			(-)P14-A/B/C	(-)P14-F/G/P	(-)P15												
1.5 Ton * SEE NOTE 3	1/4"	5/8"	117	117	117	25 / 1.00	50 / 0.99	62 / 0.98	43 / 0.98	24 / 0.97	5 / 0.97	NR	NR	NR	NR		
	5/16"	5/8"	92	92	92	25 / 1.00	50 / 0.99	75 / 0.98	98 / 0.98	93 / 0.97	88 / 0.97	83 / 0.96	78 / 0.96	73 / 0.95	68 / 0.94		
	3/8"	5/8"	66	66	66	25 / 1.00	50 / 0.99	75 / 0.98	100 / 0.98	100 / 0.97	100 / 0.97	100 / 0.96	100 / 0.96	100 / 0.95	100 / 0.94		
	1/4"	3/4" *	117	117	117	25 / 1.00	50 / 1.00	62 / 0.99	43 / 0.99	24 / 0.99	5 / 0.99	NR	NR	NR	NR		
	5/16"	3/4" *	92	92	92	25 / 1.00	50 / 1.00	75 / 0.99	98 / 0.99	93 / 0.99	88 / 0.99	83 / 0.99	78 / 0.98	73 / 0.98	68 / 0.98		
2 Ton	3/8"	3/4" *	66	66	66	25 / 1.00	50 / 1.00	75 / 1.00	100 / 0.99	100 / 0.99	100 / 0.99	100 / 0.99	100 / 0.98	100 / 0.98	100 / 0.98		
	1/4"	5/8"	n/a	n/a	n/a	25 / 0.99	50 / 0.98	21 / 0.97	NR	NR	NR	NR	NR	NR	NR		
	5/16"	5/8"	177	129	129	25 / 0.99	50 / 0.98	75 / 0.97	87 / 0.96	77 / 0.95	69 / 0.94	61 / 0.93	53 / 0.92	45 / 0.91	37 / 0.90		
	3/8"	5/8"	123	91	91	25 / 0.99	50 / 0.98	75 / 0.97	100 / 0.96	100 / 0.95	100 / 0.94	98 / 0.93	95 / 0.92	93 / 0.91	90 / 0.90		
	1/4"	3/4"	n/a	n/a	n/a	25 / 1.00	50 / 1.00	21 / 0.99	NR	NR	NR	NR	NR	NR	NR		
2.5 Ton	5/16"	3/4"	177	129	129	25 / 1.00	50 / 1.00	75 / 0.99	87 / 0.99	77 / 0.98	69 / 0.98	61 / 0.98	53 / 0.97	45 / 0.97	37 / 0.96		
	3/8"	3/4"	123	91	91	25 / 1.00	50 / 1.00	75 / 0.99	100 / 0.99	100 / 0.98	100 / 0.98	98 / 0.98	95 / 0.97	93 / 0.97	90 / 0.96		
	5/16"	5/8"	134	104	104	25 / 0.99	50 / 0.98	75 / 0.96	70 / 0.94	59 / 0.93	48 / 0.91	36 / 0.90	NR	NR	NR		
	3/8"	5/8"	94	74	74	25 / 0.99	50 / 0.99	50 / 0.98	75 / 0.96	100 / 0.94	98 / 0.93	94 / 0.91	90 / 0.90	NR	NR		
	5/16"	3/4"	134	104	104	25 / 1.00	50 / 0.99	75 / 0.99	70 / 0.98	59 / 0.98	48 / 0.97	36 / 0.96	25 / 0.96	13 / 0.95	NR		
3 Ton	3/8"	3/4"	94	74	74	25 / 1.00	50 / 0.99	75 / 0.99	100 / 0.98	98 / 0.98	94 / 0.97	90 / 0.96	86 / 0.96	82 / 0.95	78 / 0.95		
	5/16"	5/8"	122	104	104	25 / 0.99	50 / 0.97	66 / 0.94	49 / 0.92	32 / 0.90	NR	NR	NR	NR	NR		
	3/8"	5/8"	86	74	74	25 / 0.99	50 / 0.97	75 / 0.94	95 / 0.92	89 / 0.90	NR	NR	NR	NR	NR		
	5/16"	3/4"	122	104	104	25 / 1.00	50 / 0.99	66 / 0.98	49 / 0.98	32 / 0.97	15 / 0.96	NR	NR	NR	NR		
	3/8"	3/4"	86	74	74	25 / 1.00	50 / 0.99	75 / 0.98	95 / 0.98	89 / 0.97	84 / 0.96	78 / 0.95	72 / 0.94	67 / 0.93	61 / 0.93		
	1/2"	3/4"	51	45	45	25 / 1.00	50 / 0.99	75 / 0.98	100 / 0.98	100 / 0.97	100 / 0.96	100 / 0.95	100 / 0.94	100 / 0.93	100 / 0.93		
	5/16"	7/8"	122	104	104	25 / 1.00	50 / 1.00	66 / 1.00	49 / 0.99	32 / 0.99	15 / 0.99	NR	NR	NR	NR		
	3/8"	7/8"	86	74	74	25 / 1.00	50 / 1.00	75 / 1.00	95 / 0.99	89 / 0.99	84 / 0.99	78 / 0.98	72 / 0.98	67 / 0.98	61 / 0.97		
	1/2"	7/8"	51	45	45	25 / 1.00	50 / 1.00	75 / 1.00	100 / 0.99	100 / 0.99	100 / 0.99	100 / 0.98	100 / 0.98	100 / 0.98	100 / 0.97		
3.5 Ton	3/8"	3/4"	67	103	0	25 / 0.99	50 / 0.98	75 / 0.97	88 / 0.96	80 / 0.95	72 / 0.94	65 / 0.92	57 / 0.91	49 / 0.90	NR		
	1/2"	3/4"	33	59	0	25 / 0.99	50 / 0.98	75 / 0.97	100 / 0.96	100 / 0.95	100 / 0.94	100 / 0.92	100 / 0.91	100 / 0.90	NR		
	3/8"	7/8"	67	103	0	25 / 1.00	50 / 1.00	75 / 0.99	88 / 0.99	80 / 0.99	72 / 0.98	65 / 0.97	57 / 0.97	49 / 0.96	42 / 0.96		
	1/2"	7/8"	33	59	0	25 / 1.00	50 / 1.00	75 / 0.99	100 / 0.99	100 / 0.99	100 / 0.98	100 / 0.97	100 / 0.97	100 / 0.96	100 / 0.96		
4 Ton	3/8"	3/4"	97	0	0	25 / 0.99	50 / 0.98	75 / 0.96	77 / 0.95	67 / 0.93	57 / 0.92	46 / 0.91	NR	NR	NR		
	1/2"	3/4"	56	0	0	25 / 0.99	50 / 0.98	75 / 0.96	100 / 0.95	100 / 0.93	100 / 0.92	100 / 0.91	NR	NR	NR		
	3/8"	7/8"	97	0	0	25 / 1.00	50 / 0.99	75 / 0.99	77 / 0.98	67 / 0.97	57 / 0.97	46 / 0.96	36 / 0.96	26 / 0.95	15 / 0.95		
	1/2"	7/8"	56	0	0	25 / 1.00	50 / 0.99	75 / 0.99	100 / 0.98	100 / 0.97	100 / 0.97	100 / 0.96	100 / 0.96	99 / 0.95	97 / 0.95		
5 Ton	3/8"	3/4"	0	0	0	25 / 0.99	50 / 0.97	75 / 0.94	61 / 0.92	46 / 0.90	NR	NR	NR	NR	NR		
	1/2"	3/4"	0	0	0	25 / 0.99	50 / 0.97	75 / 0.94	100 / 0.92	100 / 0.90	NR	NR	NR	NR	NR		
	3/8"	7/8"	0	0	0	25 / 1.00	50 / 0.99	75 / 0.98	61 / 0.97	46 / 0.96	32 / 0.95	18 / 0.94	NR	NR	NR		
	1/2"	7/8"	0	0	0	25 / 1.00	50 / 0.99	75 / 0.98	100 / 0.97	100 / 0.96	100 / 0.95	97 / 0.94	95 / 0.94	92 / 0.93	89 / 0.92		
	3/8"	1-1/8"	0	0	0	25 / 1.01	50 / 1.01	75 / 1.00	61 / 1.00	46 / 0.99	32 / 0.99	18 / 0.99	NR	NR	NR		
1/2"	1-1/8"	0	0	0	25 / 1.01	50 / 1.01	75 / 1.00	100 / 1.00	100 / 0.99	100 / 0.99	97 / 0.99	95 / 0.99	92 / 0.99	89 / 0.98			

Notes:

- 1) Do not exceed 200 ft linear line length.
- 2) Do not exceed 100 ft vertical separation between indoor and outdoor units.
- 3) * 3/4" vapor line should only be used for 1.5 ton systems if outdoor unit is below or at same level as indoor unit to assure proper oil return.
- 4) Always use the smallest liquid line allowable to minimize refrigerant charge.
- 5) Applications shaded in light gray indicate capacity multipliers between 0.90 and 0.96 which are not recommended, but are allowed.
- 6) Applications shaded in dark gray are not recommended due to excessive liquid or suction line pressure drop.

4.0 INSTALLATION



4.5 Refrigerant Line Set Selection (cont.)

4.5.4 Vapor Line Selection

Purpose of the vapor line is to return superheated vapor to the condensing unit from the evaporator in the cooling mode and hot discharge gas to the indoor coil in the heating mode. Proper vapor line sizing is important because it plays an important role in returning oil to the compressor to prevent potential damage to the bearings, valves, and scroll sets. Also, an undersized vapor line can dramatically reduce capacity and performance of the system. The procedure for selecting the proper vapor line is as follows:

- The total amount of vapor line needed
- Add all of the equivalent lengths associated with any fittings or accessories using the table on previous page.
- Add the linear length and total fitting equivalent length. This will equal your total equivalent length.
- Reference Table 2 to verify that the calculated equivalent length falls within the acceptable region of the chart.
- Verify the capacity difference is compatible with the application using the multiplier in Table 2.
- Use only vapor line sizes listed in Table 2.

4.5.5 Long Line Set Considerations

Long line set applications are defined as applications that require accessories or alternate construction methods. The following things should be considered when selecting and installing a long line set:

- Additional refrigerant charge
- Fitting losses and maximum equivalent length considerations
- Refrigerant migration during the off cycle
- Oil return to the compressor
- Capacity losses
- System oil level adjustment

4.5.5.1 Determining if Long Line Set Length Requirements Apply

Table 2 is used to determine if the application is considered to have a long line set. A column is provided that shows the linear line length where long line length requirements apply.

4.5.5.2 Oil Return to Compressor

Small amounts of compressor crankcase oil is picked up and carried out of the compressor by

the moving refrigerant and is circulated through the system along with the refrigerant before it returns to the compressor crankcase. It is critical to the life of the compressor for the oil to be able to return to the compressor to maintain an adequate level of oil in the compressor crankcase. Oversized vapor lines result in inadequate refrigerant velocities to carry the oil along with the refrigerant and will cause the oil to accumulate in the low spots in the vapor line instead of being returned to the compressor crankcase. This is especially true for long line lengths. Only use the vapor line sizes listed in Table 2 to assure proper oil return. Do not oversize the vapor line.

4.5.5.3 Refrigerant Migration During Off Cycle

Long line set applications can require a considerable amount of additional refrigerant. This additional refrigerant needs to be managed throughout the entire ambient operating envelope that the system will go through during its life cycle. Off-Cycle migration is where excess refrigerant condenses and migrates to the coldest and/or lowest part of the system. Excessive build-up of refrigerant at the compressor will result in poor reliability and noisy operation during startup. Long line applications require TXV's on both the indoor coil and outdoor unit and a crankcase heater. (See Section 7.12 for crankcase heater information.)

4.5.5.4 Maximum Liquid Pressure Drop

The total liquid line pressure drop must not exceed 50 psig [345 kPa] to assure a solid column of liquid at the metering device and stable control of superheat. Be sure to account for vertical separation, elbows, filter driers, solenoid valves, sight glasses, and check valves when calculating liquid line pressure drop.

4.5.5.5 Liquid Line Refrigerant Flashing

Excessive pressure drop and heat gain in long liquid lines can result in the refrigerant flashing into a vapor before it reaches the metering device which will dramatically reduce the capacity and efficiency of the system. For this reason, the liquid line must be sized properly using the table in Table 2 and must be insulated in unconditioned spaces.

4.0 INSTALLATION



4.5 Refrigerant Line Set Selection (cont.)

4.5.5.6 Oil Level Adjustment for Long Line Set Applications

Additional oil will need to be added for long line set applications. (Ref. Table 2). Below is the equation for the oil level adjustment. The compressor name plate oil charge for the different outdoor units is shown in the table to the right.

Oil to be Added = [(Charge Adjustment + OD Unit Name Plate Charge (oz.)) × (0.022) – [(0.10) × (Compressor Name Plate Oil Charge (oz.))]

Example: An application requires 125 ft. of line set with a liquid line diameter of 3/8”, Charge Adjustment = 52.4 oz., Name Plate Charge = 107 oz., Name Plate Oil Charge = 25 oz., Oil to be Added = ((52.4 oz. + 107 oz.) × .022) – (.10 × 25 oz.) = 1.0 oz.

4.5.5.7 Capacity Losses

Long line lengths can result in a reduction in capacity due to vapor line pressure drop and heat gain or loss. Refer to Table 2 for capacity loss multipliers for various vapor line diameters and lengths. Only use vapor lines listed in Table 2 to assure proper oil return. This table does not account for any capacity loss due to heat gain or loss from the environment. It is extremely important not to oversize the vapor line to minimize capacity loss at the expense of proper oil return. If the table shows an “NR” for a particular vapor line diameter and length, capacity loss will be excessive. The full length of the vapor line must be insulated to minimize heat gain or loss.

OD Model	Name Plate Oil Charge (oz) [ml]	Factory Installed CCH
(-)P1418C	21 [621]	N
(-)P1424A	21 [621]	N
(-)P1430A	25 [739]	N
(-)P1436A	25 [739]	N
(-)P1442C	42 [1242]	N
(-)P1448A	42 [1242]	N
(-)P1460B	42 [1242]	Y
(-)P1418G	21 [621]	N
(-)P1424F	21 [621]	N
(-)P1430F	25 [739]	N
(-)P1436F	25 [739]	N
(-)P1442F	42 [1242]	N
(-)P1442G	42 [1242]	Y
(-)P1448F	42 [1242]	Y
(-)P1460F	42 [1242]	Y
(-)P1418AJP	21 [621]	N
(-)P1424AJP	21 [621]	N
(-)P1430AJP	25 [739]	N
(-)P1436AJP	25 [739]	N
(-)P1436BJP	25 [739]	N
(-)P1442AJP	42 [1242]	N
(-)P1448AJP	42 [1242]	N
(-)P1460AJP	42 [1242]	N

OD Model	Name Plate Oil Charge (oz) [ml]	Factory Installed CCH
(-)P1518C	21 [621]	N
(-)P1524B	21 [621]	N
(-)P1530B	25 [739]	N
(-)P1536A	25 [739]	N
(-)P1542A	42 [1242]	N
(-)P1542B	42 [1242]	Y
(-)P1548A	42 [1242]	Y
(-)P1560A	42 [1242]	Y

4.0 INSTALLATION



4.6 Line Set Installation

- If tubing is to be run underground, it must be run in a sealed watertight chase.
- Use care in routing tubing and do not kink or twist. Use a good quality tubing bender on the vapor line to prevent kinking.

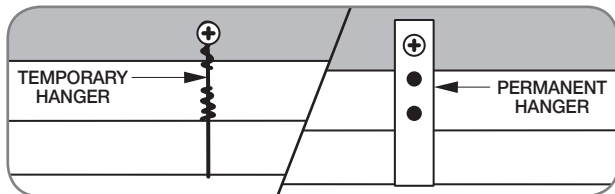

- Route the tubing using temporary hangers; then straighten the tubing and install permanent hangers. The tubing must be adequately supported.
- Isolate the vapor line from the building structure. If the vapor line comes in contact with inside walls, ceiling, or flooring, the vibration of the vapor line

in the heating mode will result in noise inside the structure.

- Blow out the liquid and vapor lines with dry nitrogen before connecting to the outdoor unit and indoor coil to remove debris that can plug the expansion device.

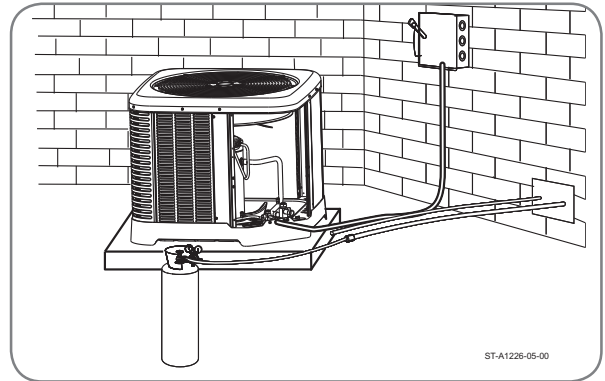

4.6.1 Important Tubing Installation Practices

Observe the following when installing correctly sized type “L” refrigerant tubing between the outdoor unit and indoor coil:

- Check the tables on Table 2 for the correct vapor line size and liquid line size.
- **If a portion of the liquid line passes through a very hot area where liquid refrigerant can be heated to form vapor, insulating the liquid line is required.**
- Use clean, dehydrated, sealed refrigeration-grade tubing.
- Always keep tubing sealed until tubing is in place and connections are to be made.
- A high-quality biflow filter drier is included with all R-410A heat pump units and must be installed in the liquid line upon unit installation.
- When replacing an R-22 system with an R-410A system and the line set is not replaced, blow out the lines with dry nitrogen to remove as much of the remaining mineral oil as possible. Check for low spots where oil may be trapped and take measures to drain the oil from those areas.

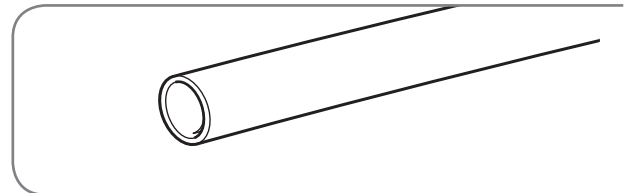

- If tubing has been cut, deburr the ends while holding the tubing in a position to prevent chips from falling into tubing. Burrs such as those caused by tubing cutters can affect performance dramatically, particularly on small diameter liquid lines.
- For best operation, keep tubing run as short as possible with a minimum number of elbows or bends.
- Locations where the tubing will be exposed to mechanical damage should be avoided. If it is necessary to use such locations, the copper tubing should be protected by a housing to prevent damage.

4.0 INSTALLATION



4.6 Line Set Installation (cont.)

4.6.2 Relative Location of Indoor and Outdoor Units

4.6.2.1 Indoor and Outdoor Unit Near Same Level

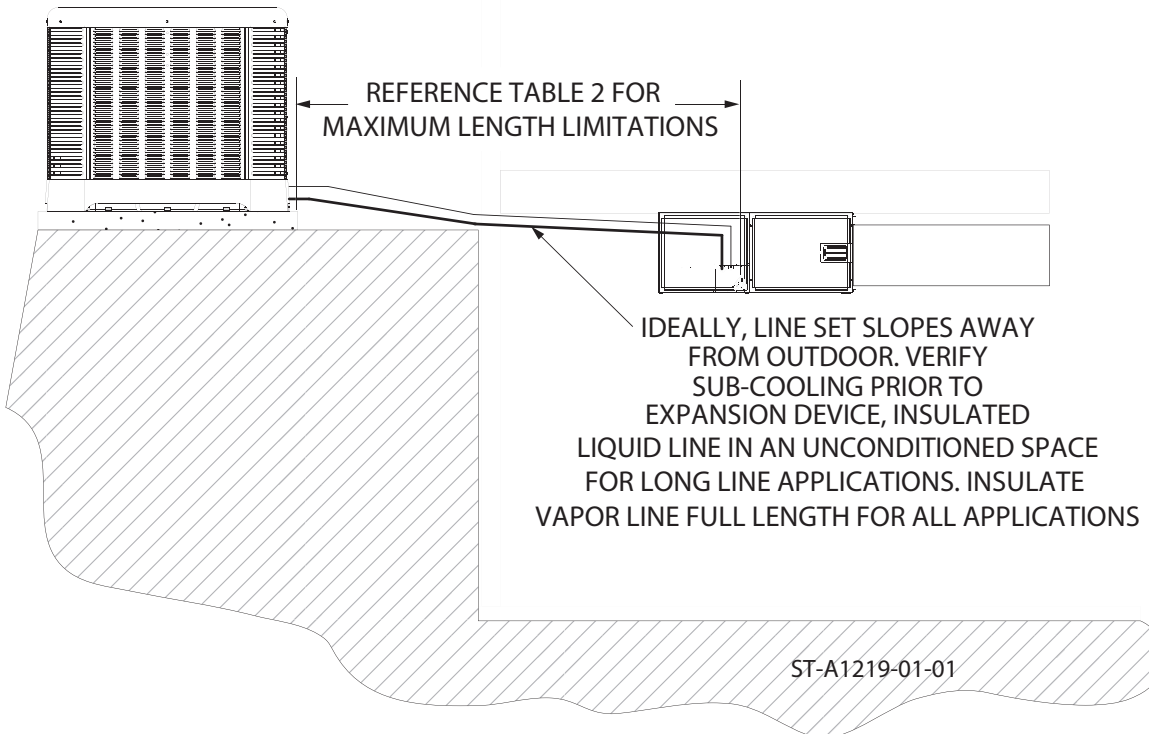

For applications that are considered to have a long line set with the outdoor unit and indoor unit near the same level the following is required:

- TXV on the indoor coil
- Start components may be required depending upon quality of voltage (consistently <200 vac at outdoor unit)
- Crankcase heater (Some models have factory installed CCH's. Refer to tables in Section 4.5.5.6.)
- Insulated liquid line in unconditioned space only. Insulated vapor line full length.
- Vapor line should slope toward the indoor unit
- Follow the proper line sizing, maximum linear and equivalent lengths, charging requirements, and oil level adjustments spelled out in this manual.
- Verify at least 5°F [2.8°C] liquid sub-cooling at the indoor unit prior to expansion device in the cooling mode.

4.0 INSTALLATION



4.6 Line Set Installation (cont.)

4.6.2.2 Outdoor Unit Below Indoor Unit

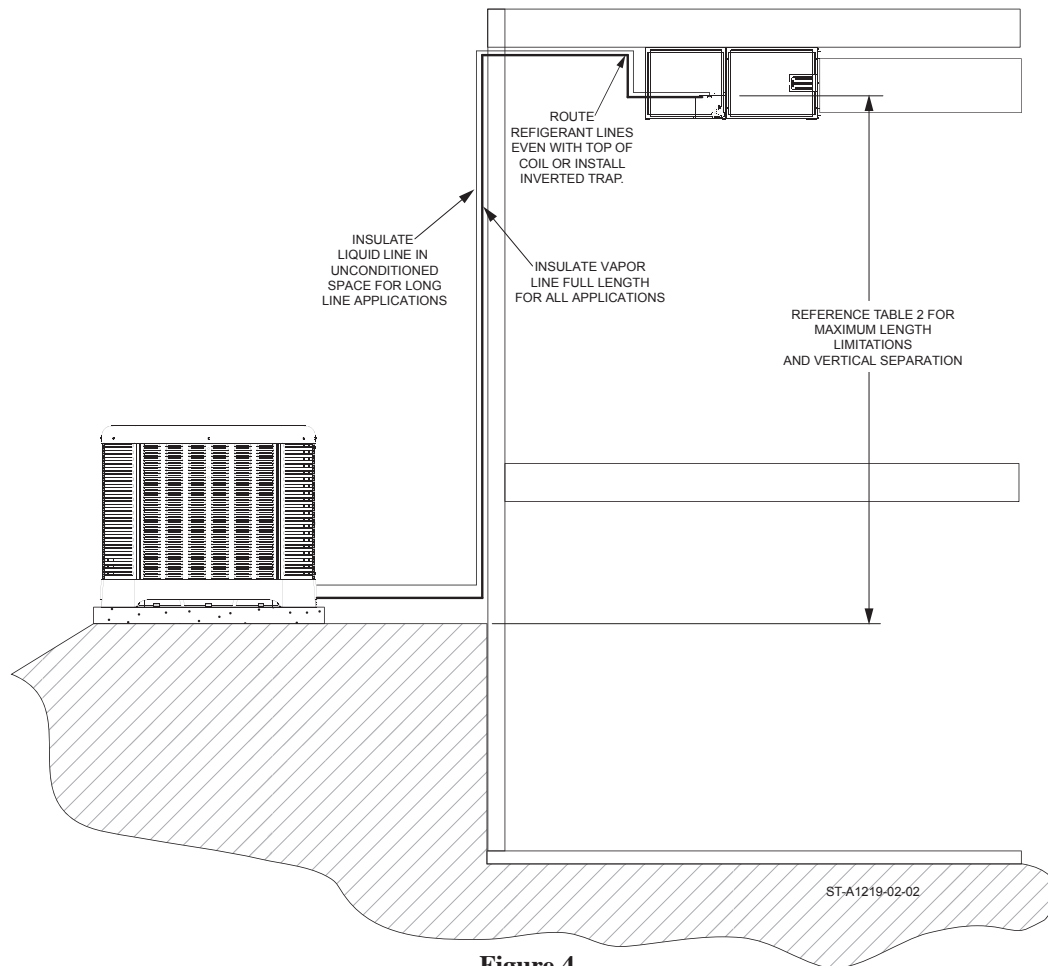

Figure 4

For applications that are considered to have a long line set with the outdoor unit below the indoor unit the following is required:

- TXV or at the indoor coil.
- Crankcase heater (Some models have factory installed CCH's. Refer to tables in Section 4.5.5.6.)
- Start components may be required depending upon quality of voltage (consistently <200 vac at outdoor unit)
- Refrigerant lines should be routed even with the top of the indoor coil or an inverted trap is to be applied (refer to Figure 4).
- Insulated liquid line in unconditioned space only. Insulated vapor line full length.
- Follow the proper line sizing, maximum linear and equivalent lengths, charging requirements, and oil level adjustments spelled out in this manual.
- Verify at least 5°F [2.8°C] liquid sub-cooling at the indoor unit prior to expansion device in the cooling mode.
- Vertical separations greater than 25' [7.62 m] can expect a lower sub-cooling level.

4.0 INSTALLATION



4.6 Line Set Installation (cont.)

4.6.2.3 Outdoor Unit Above Indoor Unit

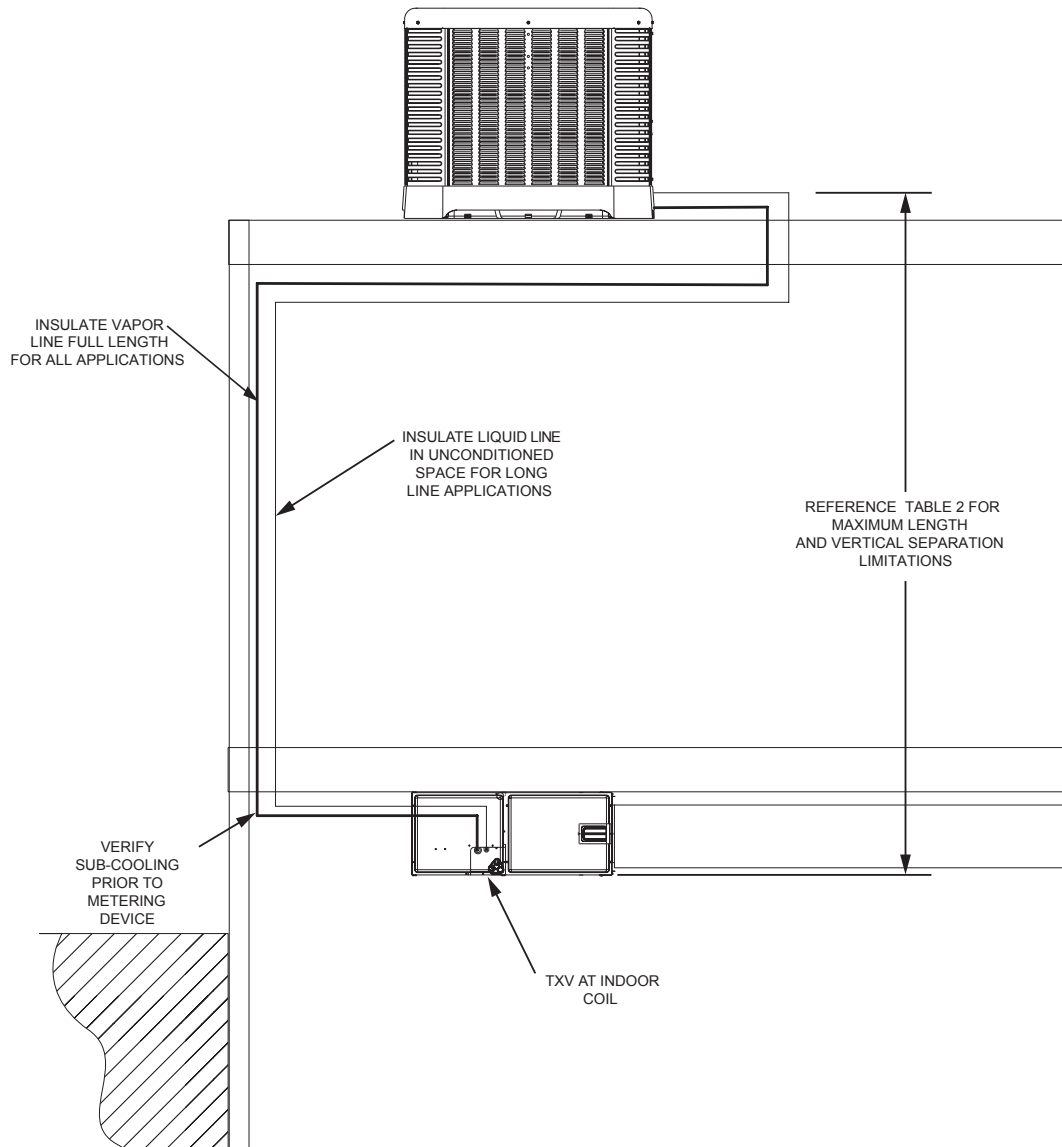

For applications that are considered to have a long line set with the outdoor unit above the indoor unit the following is required:

- TXV on the indoor coil.
- Crankcase heater (Some models have factory installed CCH's. Refer to tables in Section 4.5.5.6.)
- Start components maybe required depending upon quality of voltage (consistently <200 vac at outdoor unit)
- Insulated liquid line in unconditioned space only. Insulated vapor line full length.
- Follow the proper line sizing, maximum linear and equivalent lengths, charging requirements, and oil level adjustments spelled out in this manual.
- Verify at least 5°F [2.8°C] liquid sub-cooling at the outdoor unit service valve in the heating mode.

4.0 INSTALLATION



4.6 Line Set Installation (cont.)

4.6.3 Tubing Connections

Indoor coils have only a holding charge of dry nitrogen. Keep all tube ends sealed until connections are to be made.

- Use type “L” copper refrigeration tubing. Braze the connections with the following alloys:
 - Copper to copper, 5% silver minimum
 - Copper to steel or brass, 15% silver minimum

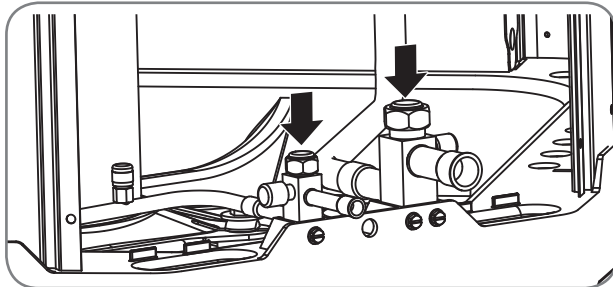

- Be certain both refrigerant shutoff valves at the outdoor unit are closed.

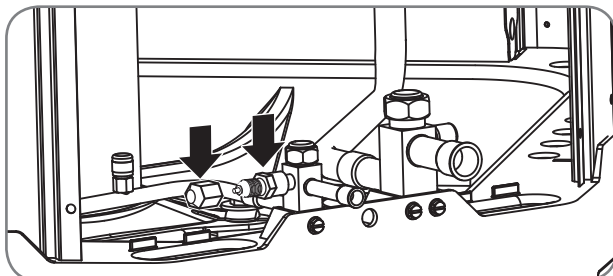

- Remove the caps and Schrader cores from the pressure ports to protect seals from heat damage. Both the Schrader valves and the service valves have seals that may be damaged by excessive heat.

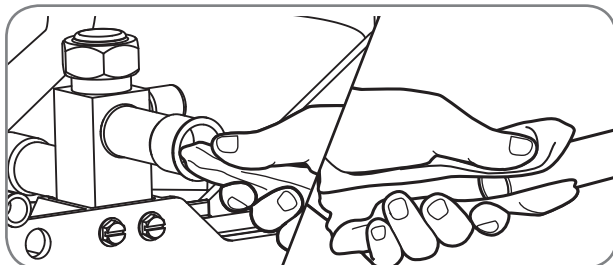

- Clean the inside of the fittings and outside of the tubing with a clean, dry cloth before soldering. Clean out debris, chips, dirt, etc., that enters tubing or service valve connections.

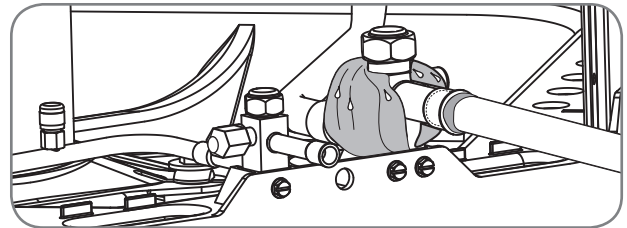

- Wrap valves with a wet rag or thermal barrier compound before applying heat.

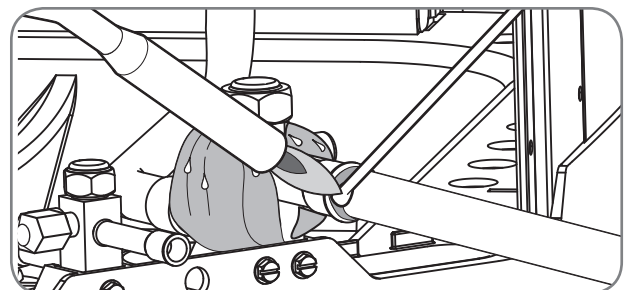

- Braze the tubing between the outdoor unit and indoor coil. Flow dry nitrogen into a pressure port and through the tubing while brazing, but do not allow pressure inside tubing which can result in leaks. Once the system is full of nitrogen, the nitrogen regulator should be turned off to avoid pressuring the system.

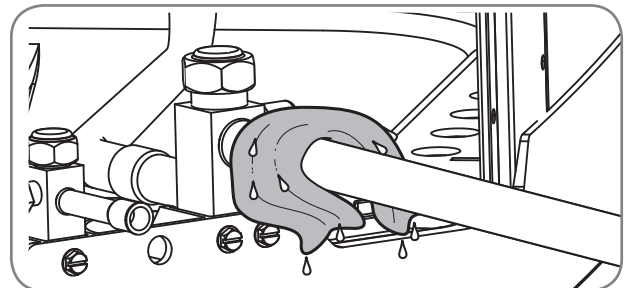

- After brazing, use an appropriate heatsink material to cool the joint.
- Reinstall the Schrader cores into both pressure ports.

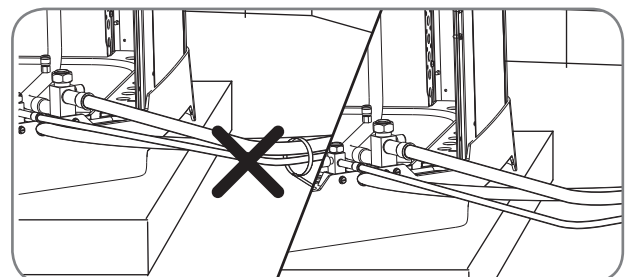

- Do not allow the bare vapor line and liquid line to be in contact with each other. This causes an undesirable heat transfer resulting in capacity loss and increased power consumption.

4.0 INSTALLATION

4.7 Initial Leak Testing

Indoor coils have only a holding charge of dry nitrogen. Keep all tube ends sealed until connections are to be made.

⚠WARNING: Do not use oxygen to purge lines or pressurize system for leak test. Oxygen reacts violently with oil, which can cause an explosion resulting in severe personal injury or death.

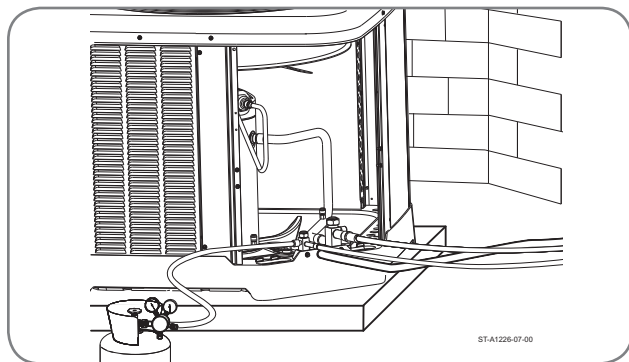

- Pressurize line set and coil through service fittings with dry nitrogen to a maximum of 150 PSIG [1034 kPa]. Close nitrogen tank valve, let system sit for at least 15 minutes, and check to see if the pressure has dropped. If the pressure has dropped, check for leaks at the line set braze joints with soap bubbles and repair leak as necessary. Repeat pressure test. If line set and coil hold pressure, proceed with line set and coil evacuation (see Sections 4.8 and 4.9 for evacuation and final leak testing).

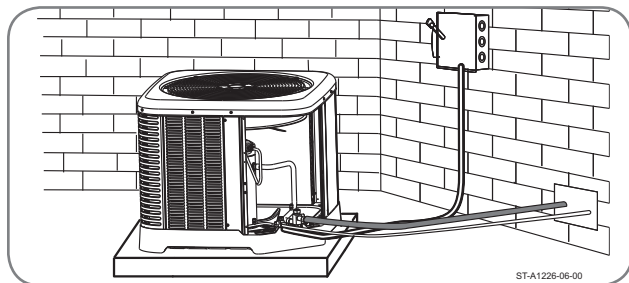

- The vapor line must be insulated for its entire length to prevent dripping (sweating) and prevent performance losses. Closed-cell foam insulation such as Armaflex and Rubatex® are satisfactory insulations for this purpose. Use 1/2" [12.7 mm] minimum insulation thickness. Additional insulation may be required for long runs. The liquid line must be insulated in any unconditioned space when long line sets are used and anytime the liquid line is run through an attic due to hot temperatures that occur there.

4.8 Evacuation

Evacuation is one of the most important parts of the entire installation and service procedure. The life and efficiency of the equipment is dependent upon the thoroughness exercised by the serviceman when evacuating air and moisture from the system.

Air or nitrogen in the system increases condensing temperature and pressure, resulting in increased power consumption, erratic operation, and reduced capacity.

Moisture chemically reacts with the refrigerant and oil to form corrosive acid which attacks the compressor motor windings and internal parts and which can result in compressor failure.

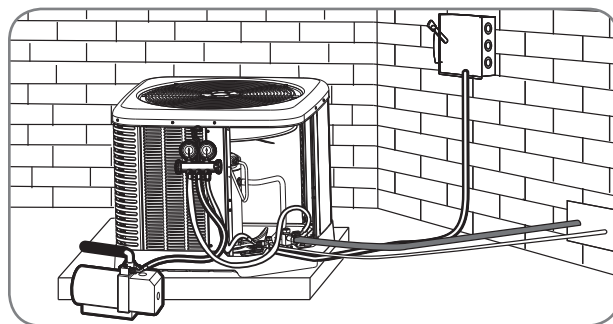

- After the system has been leak-checked and proven sealed, connect the vacuum pump and evacuate system to 500 microns and hold 500 microns or less for at least 15 minutes. The vacuum pump must be connected to both the high and low sides of the system by connecting to the two pressure ports. Use the largest size connections available since restrictive service connections may lead to false readings because of pressure drop through the fittings.

4.9 Final Leak Testing

After the unit has been properly evacuated and service valves opened, a halogen leak detector should be used to detect leaks in the system. All joints and piping within the outdoor unit, evaporator, and interconnecting tubing should be checked for leaks. If a leak is detected, the refrigerant should be recovered before repairing the leak. The Clean Air Act prohibits releasing refrigerant into the atmosphere.

4.0 INSTALLATION



4.10 Control Wiring

⚠WARNING: Turn off electric power at the fuse box or service panel before making any electrical connections. Also, the ground connection must be completed before making line voltage connections. Failure to do so can result in electrical shock, severe personal injury, or death.

Running low-voltage wires in conduit with line voltage power wires is not recommended. Low-voltage wiring should be attached to the pigtails below the control box.

A thermostat and a 24-volt, 40 VA minimum transformer are required for the control circuit of the system. The furnace or the air handler transformer may be used if sufficient. See the wiring diagram for reference. Use “Wire Size”

guide below to size the 24-volt control wiring.

Do not use phone cord to connect indoor and outdoor units and thermostat. This could damage the controls and may not be adequately sized for the control’s electrical load.

FIELD WIRE SIZE FOR 24-VOLT THERMOSTAT CIRCUITS:

Runs up to 100 ft [30.5 m]: 18 AWG

Runs over 100 ft [30.5 m]: 16 AWG

NOTICE: Do not use control wiring smaller than No. 18 AWG between thermostat and outdoor unit.



4.11 Typical Control Wiring Diagrams

The following figures show the typical wiring diagrams for air handlers and a 1-stage heat pump and dual fuel applications with a gas furnace and a 1-stage heat pump.

WIRE COLOR CODE		
BK – BLACK	GY – GRAY	W – WHITE
BR – BROWN	O – ORANGE	Y – YELLOW
BL – BLUE	PR – PURPLE	
G – GREEN	R – RED	

Wiring

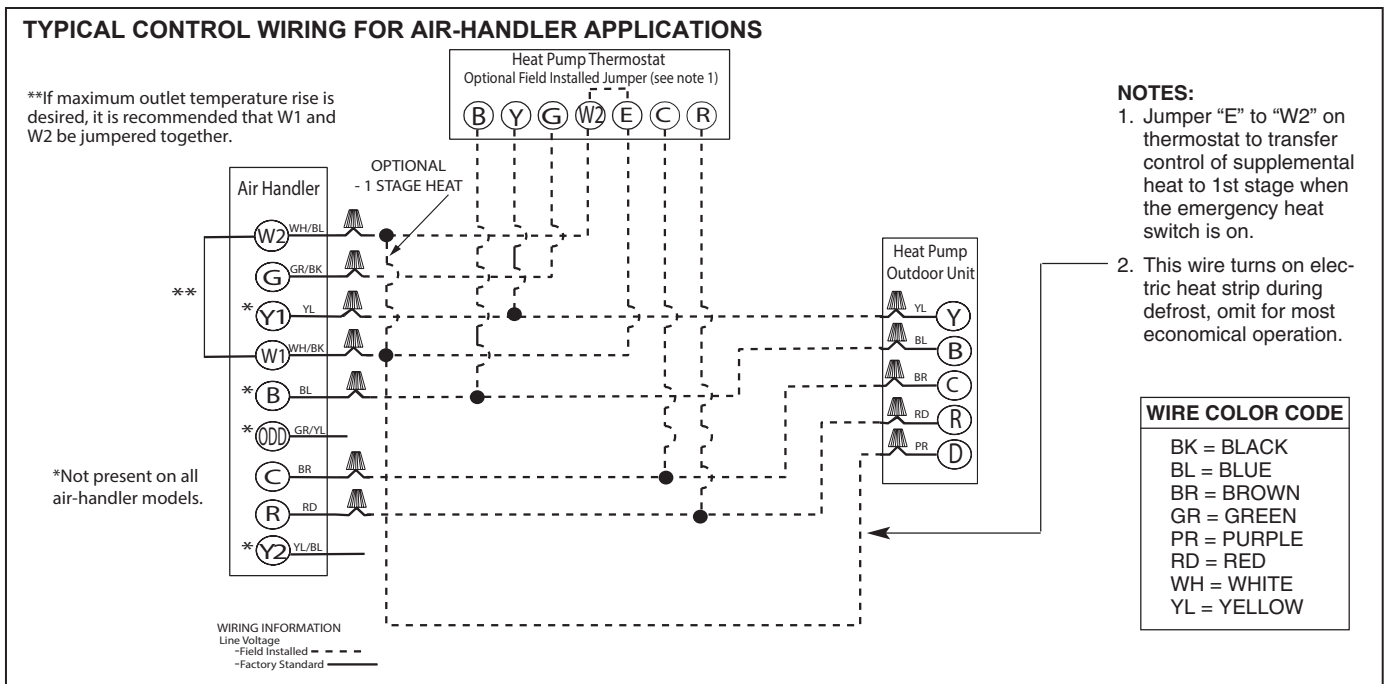

4.0 INSTALLATION



4.11 Typical Control Wiring Diagrams (cont.)

TYPICAL 1-STAGE DUAL FUEL THERMOSTAT AND DUAL-FUEL APPLICATION

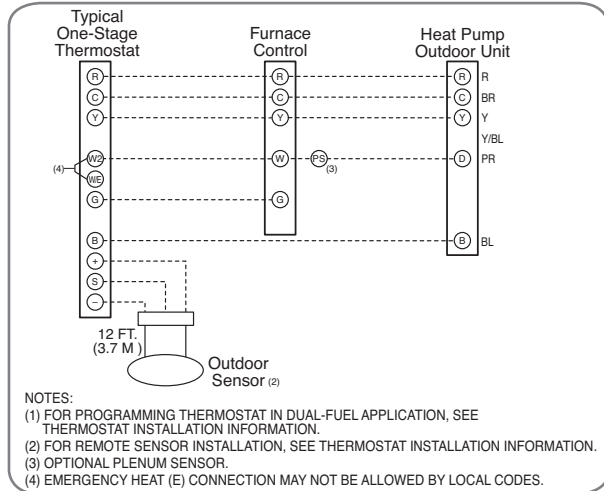

NOTICE: Field wiring must comply with the National Electric Code (C.E.C. in Canada) and any applicable local code.

4.12 Power Wiring

It is important that proper electrical power from a commercial utility is available at the heat pump contactor. Voltage ranges for operation are shown below.

VOLTAGE RANGES (60 HZ)

Nameplate Voltage	Operating Voltage Range at Maximum Load Design Conditions for Compressors
208/230 (1 Phase)	187 - 253
208/230 (3 Phase)	187 - 253
460	414 - 506

Install a branch circuit disconnect within sight of the unit and of adequate size to handle the minimum circuit capacity (see Section 3.3).

Power wiring must be run in a rain-tight conduit. Conduit must be attached to the hole in the bottom of the control box as shown below.

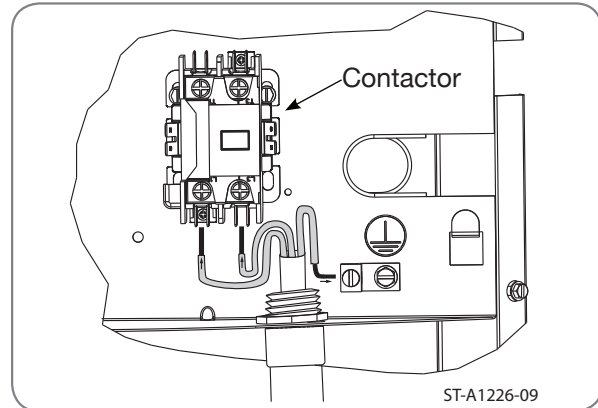

Connect power wiring to line-voltage lugs on the contactor located in the outdoor heat pump unit electrical box. (See wiring diagram attached to unit access panel and above illustration.)

Check all electrical connections, including factory wiring within the unit and make sure all connections are tight.

DO NOT connect aluminum field wire to the contactor terminals.

4.13 Grounding

⚠WARNING: The unit must be permanently grounded. Failure to do so can cause electrical shock resulting in severe personal injury or death.

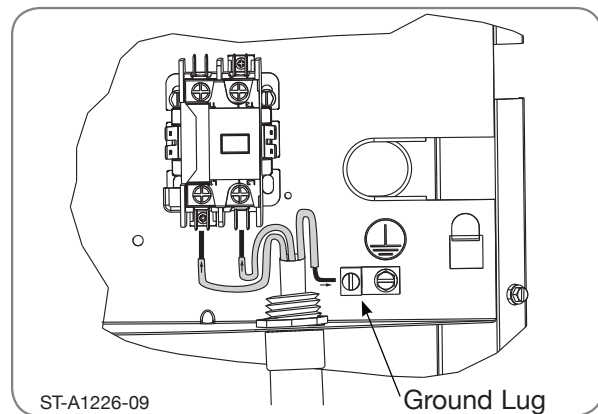

A grounding lug is provided near the line-voltage power entrance for a ground wire as shown in the above illustration.

5.0 SYSTEM START-UP & REFRIGERANT CHARGING

5.1 System Start-Up Overview

Once the system hardware and wiring has been properly installed, the next step is to start the system up, verify indoor air-flow, and adjust the refrigerant charge. To assure optimum comfort, efficiency, and reliability, it is extremely important to follow the procedures in this section to assure the indoor air-flow and refrigerant charge are correct.

⚠️WARNING: Single-pole contactors are used on all standard single-phase units through 5 tons. Caution must be exercised when servicing as only one leg of the power supply is broken by the contactor.

5.2 Initial System Power-Up

After all installation steps have been completed, apply electrical power to the indoor and outdoor unit only until the indoor air-flow is verified (See Section 5.3).

After the indoor air-flow has been verified and the preliminary refrigerant charge has been weighed in (see section 5.4.2), electrical power may be applied to the outdoor unit. If the unit is equipped with a crankcase heater, it is recommended to wait at least 12 hours after electrical power is applied to the outdoor unit before starting the compressor to assure any liquid refrigerant inside the compressor has been driven out by the crankcase heater.

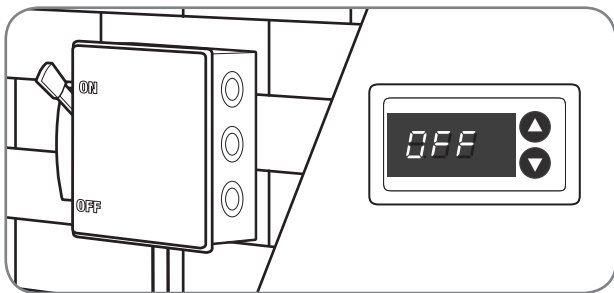

5.3 Verifying Indoor Air-Flow

The air distribution system has the greatest effect on airflow. The duct system is totally controlled by the contractor. For this reason, the contractor should use only industry-recognized procedures. Duct design and construction should be carefully done. System performance can be lowered

dramatically through bad planning or workmanship. Air supply diffusers must be selected and located carefully. They must be sized and positioned to deliver treated air along the perimeter of the space. If they are too small for their intended airflow, they become noisy. If they are not located properly, drafts can result. Return air grilles must be properly sized to carry air back to the blower. If they are too small, they also cause noise.

The installers should balance the air distribution system to ensure proper and quiet airflow to all rooms in the home. This ensures a comfortable living space.

The correct air quantity is critical to air conditioning systems. Proper operation, efficiency, compressor life, and humidity control depend on the correct balance between indoor load and outdoor unit capacity. Excessive indoor airflow increases the possibility of high humidity problems. Low indoor airflow reduces total capacity and can cause coil icing. Serious harm can be done to the compressor by low airflow, such as that caused by refrigerant flooding.

Heat pump systems require a specified airflow. Each ton of cooling requires between 320 and 450 cubic feet of air per minute (CFM). See the manufacturer's spec sheet or the AHRI Directory (ahridirectory.org) for rated airflow for the system being installed.

The indoor air-flow must be verified to be correct before the refrigerant charging process can begin. Determine the rated indoor air-flow by referring to the AHRI Directory or manufacturer's outdoor unit specifications for the particular indoor and outdoor unit combination being installed. Then refer to the air-handler or gas furnace installation manual to determine how to select the proper air-flow and make the necessary adjustments to achieve as close to the rated indoor air-flow as possible. Once the adjustments have been made, the air-handler or gas furnace blower can be started by turning the thermostat to the heating mode and adjusting the set point above the room temperature so the air-flow level can be verified using the following methods.

IMPORTANT: Power to the outdoor unit must remain off until the indoor air-flow is verified and the outdoor unit service valves are opened to release the factory refrigerant charge into the line set and indoor coil.

These simple mathematical formulas can be used to determine the CFM in a residential or light commercial system.

Electric resistance heaters can use:

5.0 SYSTEM START-UP & REFRIGERANT CHARGING

$$\text{CFM} = \frac{\text{volts} \times \text{amps} \times 3.413}{\text{SHC} \times \text{temp rise}}$$

Gas furnaces can use:

$$\text{CFM} = \frac{\text{Output Capacity in BTUH}^*}{\text{SHC} \times \text{temp rise}}$$

*Refer to furnace data plate for furnace output capacity.

SHC = Sensible Heat Constant (see table below)

An air velocity meter or airflow hood can give a more accurate reading of the system CFM.

The measurement for temperature rise should be performed at the air-handler or furnace return air inlet and in the supply plenum, but out of direct line of sight of the heater element or heat exchanger. For best results, measure air temperature at multiple points and average the measurements to obtain inlet and outlet temperatures.

ALTITUDE (FEET)	SENSIBLE HEAT CONSTANT (SHC)	ALTITUDE (FEET)	SENSIBLE HEAT CONSTANT (SHC)
Sea Level	1.08	6000	0.87
500	1.07	7000	0.84
1000	1.05	8000	0.81
2000	1.01	9000	0.78
3000	0.97	10000	0.75
4000	0.94	15000	0.61
5000	0.90	20000	0.50

5.4 Refrigerant Charging

⚠ WARNING: The top of the scroll compressor shell is hot. Touching the compressor top may result in serious personal injury.

⚠ CAUTION: R-410A pressures are approximately 60% higher (1.6 times) than R-22 pressures. Use appropriate care when using this refrigerant. Failure to exercise care may result in equipment damage or personal injury.

Charge for all systems should be checked using the Charging Chart inside the access panel cover.

IMPORTANT: Do not operate the compressor without charge in the system.

Addition of R-410A will raise high-side pressures (liquid and discharge).

NOTICE: System maintenance is to be performed by a qualified and certified technician.

The refrigerant charge for all systems should be checked against the Charging Chart located inside the access panel cover.

The optimum refrigerant charge for any outdoor unit matched with an indoor coil/air handler is affected by the application. Therefore, charging data has been developed to assist the field technician in optimizing the charge for all mounting configurations (UF – Upflow, DF – Downflow, LH – Left-Hand Discharge, and RH – Right-Hand Discharge). Refer to the charging chart inside the access panel cover on the unit and choose the appropriate column for the specific application being installed or serviced. New installations utilizing either an RCF indoor coil installed on a gas furnace or an RH series air handler in the downflow or horizontal right-hand discharge may require removal of refrigerant since the factory charge could result in an overcharge condition.

The following method is used for charging systems in the cooling and heating mode. All steps listed should be performed to ensure proper charge has been set. For measuring pressures, the service valve port on the liquid valve (small valve) and the true service port located between the two service valves are to be used.

5.4.1 Measurement Device Set-Up

1. With an R-410A gauge set, attach the high-pressure hose to the access fitting on the liquid line (small) service valve at the OD unit.
2. Attach the low-pressure hose to the exterior true suction port located between the two service valves that is connected to the suction tube between the reversing valve and compressor.
3. Attach a temperature probe within 6" [15.2 cm] of the outside of the unit on the copper liquid line (small line). For more accurate measurements, clean the copper line prior to measurement and use a calibrated clamp-on temperature probe or an insulated surface thermocouple.

5.4.2 Preliminary Charging by Weight

NOTICE: Adjust the system charge by weight for the linear length of the refrigerant line set.

For a new installation, evacuation of inter-connecting tubing and indoor coil is adequate; otherwise, evacuate the entire system. Use the factory charge shown in "Electrical and Physical Data" in Section 3.3 of these instructions or on the unit data plate. Note that the charge value includes charge required for 15 ft. [4.6 m] of standard-size liquid line without a filter drier.

Calculate actual charge required with the actual installed liquid line size and length using:

5.0 SYSTEM START-UP & REFRIGERANT CHARGING

1/4" [6.4 mm] O.D. = .3 oz./ft. [8.5 g/.30 m]
5/16" [7.9 mm] O.D. = .4 oz./ft. [11.3 g/.30 m]
3/8" [9.5 mm] O.D. = .6 oz./ft. [17.0 g/.30 m]
1/2" [12.7 mm] O.D. = 1.2 oz./ft. [34.0 g/.30 m]

Add 6 oz. for field-installed filter drier.

Charge Adjustment = (Line Set (oz./ft.) × Total Linear Length) – Factory Charge for Line Set + 6 oz. (for field installed filter drier)

Example: A three-ton heat pump unit requires 75 ft. of line set with a liquid line diameter of 1/2".

Factory Charge for Line Set = 15 ft. × .6 oz. = 9 oz.

Charge Adjustment = (1.2 oz. × 75 ft.) – 9 oz. + 6 oz. = + 87 oz.

With an accurate scale (+/- 1 oz. [28.3 g]) or volumetric charging device, adjust the refrigerant charge based on the actual line set length. If the entire system has been evacuated, add the total calculated charge.

IMPORTANT: Charging by weight is not always accurate since the application can affect the optimum refrigerant charge. Charging by weight is considered a starting point ONLY. Always check the charge by using the Charging Chart and adjust as necessary. CHARGING BY LIQUID SUBCOOLING PER THE SYSTEM CHARGING CHART MUST BE USED FOR FINAL CHARGE ADJUSTMENT.

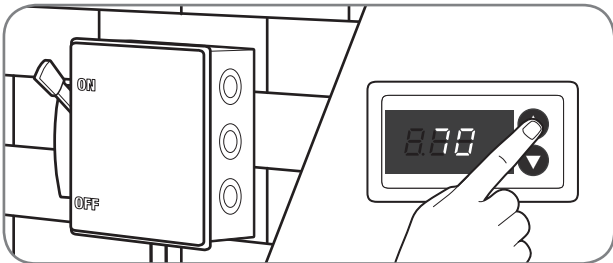

IMPORTANT: R-410A is a blended refrigerant of R-32 and R-125 (50/50). These two refrigerants have different saturation curves and therefore change state at different pressures and temperatures. If charge is added to the system in the vapor state, it is possible to have a disproportionate amount of each part of the R-410A blend which will cause unstable and inefficient operation. Therefore, it is critical to add R-410A in the liquid form only!

5.4.3 Preliminary Charging by Pressures

1. Following airflow verification and charge weigh-in, run the unit for a minimum of 15 minutes prior to noting pressures and temperatures.

IMPORTANT: Indoor conditions as measured at the indoor coil must be within 2°F [1.1°C] of comfort conditions per the homeowner's preference.

NOTICE: If the indoor temperature is above or below this range, run the system to bring the temperature down or run the electric heat/furnace to bring the temperature within this range.

2. Note the Outdoor Dry Bulb Temperature, ODDB° = ____°F [____°C]. Unit charging is recommended under the following outdoor conditions ONLY:

Cooling Mode ONLY: 55°F [12.8°C] outdoor dry bulb and above

Heating Mode ONLY: Between 40°F [4.4°C] and 60°F [15.6°C] outdoor dry bulb

3. Locate and note the design pressures. The correct liquid and vapor pressures are found at the intersection of the installed system and the outdoor ambient temperature on the Charging Chart located inside the access panel cover.

Liquid Pressure: = ____psig; Vapor Pressure = ____psig

NOTICE: The refrigerant pressures provided are for preliminary charge check ONLY. These pressure values are typical, but may vary due to application. Evaporator load (indoor coil in cooling mode/outdoor coil in heating mode) will cause pressures to deviate. The values listed are for the correct matched indoor coil ONLY!

4. If the measured liquid pressure is below the listed requirement for the given outdoor and indoor conditions, add charge. If the measured liquid pressure is above the listed requirement for the given outdoor and indoor conditions, remove charge.

5.4.4 Final Charging by Liquid Subcooling

1. After preliminary charging by weight or pressures, find the design subcooling value. The correct subcooling value is found at the intersection of the installed system and the outdoor ambient temperature on the Charging Chart located inside the access panel cover.
SC° from Charging Chart = ____°F [____°C].

IMPORTANT: Indoor conditions as measured at the indoor coil are required to be within 2°F (1.1°C) of comfort conditions as preferred by the homeowner and must have

5.0 SYSTEM START-UP & REFRIGERANT CHARGING

operated for at least 15 minutes prior to final charge adjustment. Unit charging is recommended under the following outdoor conditions ONLY:

Cooling Mode: 55°F [12.8°C] outdoor dry bulb and above

Heating Mode: Between 40°F [4.4°C] and 60°F [15.6°C] outdoor dry bulb

NOTICE: Systems should not be charged below 40°F [4.4°C] outdoor temperature.

NOTICE: If the indoor temperature is above or below the recommended range, run the system to bring the temperature down or run the electric heat/furnace to bring the temperature up.

2. Note the measured Liquid Pressure, $P_{liq} =$ _____psig, as measured from the liquid (small) service valve. Use the Temperature Pressure Chart below to note the corresponding saturation temperature for R-410A at the measured liquid pressure.

Liquid Saturation Temperature, $SAT^{\circ} =$ _____°F [_____]°C.

3. Note the liquid line temperature, $Liq^{\circ} =$ _____°F [_____]°C, as measured from a temperature probe located within 6" [15.2 cm] outside of the unit on the copper liquid line (small line). It is recommended to use a calibrated clamp-on temperature probe or an insulated surface thermocouple.

4. Subtract the liquid line temperature from the saturation temperature to calculate subcooling. SAT° _____°F [_____]°C - Liq° _____°F [_____]°C = SC° _____°F [_____]°C

5. Adjust charge to obtain the specified subcooling value. If the measured subcooling level is below the listed requirement for the given outdoor temperature, add charge. If the measured subcooling level is above the listed requirement for the given outdoor temperature, remove charge.

5.4.5 R-410A Temperature Pressure Chart

SATURATION TEMP (Deg. F) [Deg. C]	R-410A PSIG	SATURATION TEMP (Deg. F) [Deg. C]	R-410A PSIG	SATURATION TEMP (Deg. F) [Deg. C]	R-410A PSIG	SATURATION TEMP (Deg. F) [Deg. C]	R-410A PSIG
-150 [-101]	-	-30 [-34]	17.9	35 [2]	107.5	100 [38]	317.4
-140 [-96]	-	-25 [-32]	22.0	40 [4]	118.5	105 [41]	340.6
-130 [-90]	-	-20 [-29]	26.4	45 [7]	130.2	110 [43]	365.1
-120 [-84]	-	-15 [-26]	31.3	50 [10]	142.7	115 [46]	390.9
-110 [-79]	-	-10 [-23]	36.5	55 [13]	156.0	120 [49]	418.0
-100 [-73]	-	-5 [-21]	42.2	60 [16]	170.1	125 [52]	446.5
-90 [-68]	-	0 [-18]	48.4	65 [18]	185.1	130 [54]	476.5
-80 [-62]	-	5 [-15]	55.1	70 [21]	201.0	135 [57]	508.0
-70 [-57]	-	10 [-12]	62.4	75 [24]	217.8	140 [60]	541.2
-60 [-51]	0.4	15 [-9]	70.2	80 [27]	235.6	145 [63]	576.0
-50 [-46]	5.1	20 [-7]	78.5	85 [29]	254.5	150 [66]	612.8
-40 [-40]	10.9	25 [-4]	87.5	90 [32]	274.3		
-35 [-37]	14.2	30 [-1]	97.2	95 [35]	295.3		

5.5 Completing Installation

- Disconnect the hoses from the pressure ports. Replace the pressure port caps and tighten adequately to seal caps. **Do not overtighten.**
- Replace the service valve top caps finger-tight and then tighten with a wrench to adequately seal caps. **Do not overtighten.**
- Replace control box cover and service panel and install screws to secure panels.
- Restore power to unit at disconnect if required.
- Configure thermostat per the thermostat installation instructions and set to desired mode and temperature.

6.0 SEQUENCE OF OPERATION

6.1 Cooling Mode

When the thermostat calls for cooling, the compressor, outdoor fan motor, and indoor blower motor are energized and the system provides cooling and dehumidification for the conditioned space. When the thermostat call for cooling is satisfied or turned to the off position. The compressor and outdoor fan motor are de-energized and the indoor blower motor continues to operate for an additional 30 – 45 seconds to extract the residual cooling from the cold indoor coil.

6.2 Heating Mode

When the heat pump thermostat is set to “heat” mode, the “B” terminal on the outdoor unit is en-

energized which energizes the reversing valve and switches it to the heating position. When the thermostat calls for heating, the compressor, outdoor fan motor, and indoor blower motor are energized and the system provides heating for the conditioned space. When the thermostat call for heat is satisfied. The compressor and outdoor fan are de-energized and the indoor blower motor continue to operate for an additional 30 – 45 seconds to extract the residual heat from the warm indoor coil. If the thermostat is switched to the OFF, the reversing valve solenoid is de-energized. If the system is operating in the heating mode when the thermostat is switched to the OFF position, the reversing valve will shift to the cooling position and will remain there until the thermostat is switched back to the HEAT mode and there is a call for heating.

6.0 SEQUENCE OF OPERATION

6.3 Supplemental Electric Heat in Heating Mode

If the building load should exceed the heating capacity in extreme outdoor conditions, the thermostat will direct the air-handler to energize supplemental electric heat as required to meet the building load. For 13kW heaters and higher, the supplemental electric heat can be energized in two separate stages if the thermostat provides for 3 stages of heat (Y - heat pump, W1 - 1st stage electric heat, and W2 - 2nd stage electric heat). The compressor and outdoor fan will continue to operate at maximum capacity while supplemental electric heat is energized.

6.4 Dual Fuel Applications – Heating Mode

If the building load should exceed the heat pump heating capacity in extreme outdoor conditions, the thermostat will direct the outdoor unit to shut down and heating responsibility will be transferred to the gas furnace. An outdoor ambient temperature can be set in dual fuel enabled thermostats to direct the system to automatically switch to gas heat when the outdoor ambient temperature drops below that set-point. If the thermostat is set to the EMERGENCY HEAT mode, heating responsibility will be transferred to the gas furnace.

6.5 Demand Defrost

Defrosting of the outdoor coil in the heating mode is controlled by the defrost control located in the outdoor unit. (-)P14 and (-)P15 heat pumps feature “demand defrost” that initiate a defrost cycle only when frosting is detected on the outdoor coil during heating operation. The defrost control monitors the Outdoor Ambient Temperature Thermistor and Outdoor Coil Temperature Thermistor to determine when a defrost cycle is required. The following sequence is followed for defrost cycles.

- **Defrost Initiation:** A defrost cycle is initiated when the following conditions are met.
 1. The outdoor coil temperature is below 35°F [1.7°C].
 2. The compressor has operated for at least 34 minutes with the outdoor coil temperature below 35°F [1.7°C].
 3. The defrost control determines a defrost cycle is required based on the outdoor ambient and outdoor coil temperatures.

If the above conditions are met, the following action will be taken.

1. The reversing valve is de-energized which will cause it to shift to the cooling position and the outdoor fan motor is de-energized.
2. The compressor is de-energized for a 30 second noise abatement period.
3. The indoor air-handler or gas furnace is directed to supply supplemental heat to prevent cold air from being discharged from the supply registers during the defrost cycle.
4. The compressor is energized after the 30 second delay has been completed and defrosting of the coil begins.

- **Defrost Termination:** The defrost cycle will continue until the coil temperature has reached the termination temperature or 14 minutes have elapsed, whichever comes first. The factory default termination temperature is 70°F [21.1°C], although this temperature can be changed to 50°F [10.0°C], 60°F [15.6°C], or 80°F [26.7°C] by relocating a jumper on the defrost control board. When the coil temperature reaches the termination temperature or 14 minutes have elapsed, the following action is taken.
 1. The reversing valve will be energized, switching it back to the heating position.
 2. The compressor is de-energized for a 30 second noise abatement period.
 3. Supplemental heat is de-energized.
 4. The compressor and outdoor fan motor are energized after the 30 second delay has been completed.
 5. The system returns to normal heating operation as directed by the thermostat.

NOTE: Should the outdoor ambient temperature thermistor fail, the defrost control will initiate a defrost cycle every 34 minutes of operation when the coil temperature is below 35°F [1.7°F].

See Section 7.1 (Demand Defrost Control) for additional information.

7.0 COMPONENTS & CONTROLS

7.1 Demand Defrost Control

When the thermostat calls for cooling, the demand defrost control monitors the outdoor ambient temperature, outdoor coil temperature and the compressor run time to determine when a defrost cycle is required.

The defrost control has high and low pressure control inputs with unique pressure switch logic built into the microprocessor to provide compressor and system protection without nuisance lockouts. The control cycles the compressor off for 30 seconds at the beginning and the end of the defrost cycle to eliminate the increased compressor noise caused by rapidly changing system pressures when the reversing valve switches. See Sections 9.1 and 9.2 for diagnostic flash codes and sensor resistance values at various temperatures.

Defrost Initiation

A defrost will be initiated when the three conditions below are satisfied:

1. The outdoor coil temperature is below 35°F [1.7°C] as measured by a good coil sensor,
2. The compressor has operated for at least 34 minutes with the outdoor coil temperature below 35°F [1.7°C] and
3. The measured difference between the ambient temperature and the outdoor coil temperature is greater than the calculated difference determined by the microprocessor.

Defrost Termination

Once a defrost is initiated, the defrost will continue until 14 minutes has elapsed or the coil temperature has reached the selected termination temperature. The factory setting is 70°F [21.1°C] but can be changed to 50°F [10°C], 60°F [15.6°C] or 80°F [26.7°C] by relocating the jumper on the control board.

Temperature Sensors

The coil sensor is located on the outdoor coil at the point fed by the distribution tubes from the metering device (short 3/8" dia. Tube). The ambient air sensor is located below the control box so it can sense outdoor temperatures.

If the outdoor ambient sensor fails, the defrost control will initiate a defrost every 34 minutes of compressor run time with the coil temperature below 35°F [1.7°C].

If the coil sensor fails, the defrost control will not initiate a defrost.

Test Mode

The test mode is initiated by momentarily shorting the two TEST pins. The unit must have an active heat pump heating call to enter the test mode. In this mode of operation, the enable temperature is ignored and all timers are sped up. To initiate a manual defrost, short and hold the TEST pins. Remove the short when the system switches to defrost mode after the compressor noise abatement delay. The defrost will terminate on time (14 minutes) or when the termination temperature has been reached.

Test Sequence of Operation:

- 1) Provide a heating call to the heat pump.
- 2) Short test pins to bypass anti-short cycle timer. (If unit is running, this step is not necessary.)
- 3) Short test pins and hold them shorted to enter defrost mode.
- 4) Release test pins once control exits noise abatement delay.
- 5) Monitor coil temperature when control exits defrost.
- 6) Unit should return to heating mode.

Troubleshooting Demand Defrost

During the test mode the coil temperature should be monitored. If the system exits defrost at approximately the termination temperature, the control is operating normally.

If not, one item to check is the coil and ambient temperature sensor resistance, using the temperature/resistance chart in Section 9.2.

Immerse the sensor in water and measure the resistance of the sensor. At 35°F [1.7°C] the resistance of the sensor should be approximately 30,000 ohms.

Ensure that the coil sensor is properly installed that it is not loose or touching the cabinet.

High/Low Pressure Control Monitoring

Status of high and low pressure controls is monitored and the following actions are taken.

High Pressure Control – Provides active protection in both cooling and heating modes at all outdoor ambient temperatures. The high pressure control is an automatic reset type and opens at approximately 610 psig [4206 kPa] and closes at approximately 420 psig [2896 kPa]. The compressor and fan motor will stop when the high pressure control opens and will start again if the high side pressure drops to approximately 420 psig [2896 kPa] where the automatic reset high pressure control resets. If the high pressure control opens 3 times within a particular call for heating or cooling operation, the defrost control will lock out compressor and outdoor fan operation.

7.0 COMPONENTS & CONTROLS

Low Pressure Control – Provides active protection in both heating and cooling modes at all outdoor ambient temperatures. The low pressure control is an automatic reset type and opens at approximately 15 psig [103 kPa] and closes at approximately 40 psig [276 kPa]. Operation is slightly different between cooling and heating modes.

Cooling Mode: The compressor and fan motor will stop when the low pressure control opens and will start again when the low side pressure rises to approximately 40 psig [276 kPa] when the low pressure control automatically resets. If the low pressure switch opens 3 times within a particular call for cooling operation, the defrost control will lock out compressor and fan operation.

Heating Mode: The compressor and fan motor will stop when the low pressure control opens and will start again when the low side pressure rises to approximately 40 psig [276 kPa] when the low pressure automatically resets. If the low pressure switch trips 3 times within 120 minutes of operation during a particular call for heating operation, the defrost control will lock out compressor and outdoor fan operation. If the lock out due to low pressure occurs at an outdoor ambient temperature below 5°F [-15°C], the defrost control will automatically exit the lockout mode when the outdoor ambient temperature rises to 5°F [-15°C]. This feature is necessary since the low pressure control could possibly have opened due to the outdoor ambient being very low rather than an actual system fault.

Exiting Lock-Out Mode: To exit the lock-out mode, remove 24 volts to the defrost control by removing power to the indoor air handler/furnace or by shorting the two defrost control test pins together.

7.2 Compressor

Scroll compressors are used in all (-)P14 and (-)P15 heat pumps. All compressors have a special internal feature that minimizes noise when the reversing valve shifts during the defrost mode.

7.3 Fan Motor

Most (-)P14 and (-)P15 heat pumps are equipped with a standard PSC motor, but a few models utilize a high efficiency single-speed ECM motor.

7.4 Outdoor Fan

All models utilize a standard paddle 2 or 3 blade fan made from either aluminum or coated steel.

7.5 Compressor Contractor

All single-phase models utilize a single-pole contactor to power the compressor and fan motor. All 3-phase models utilize a 3-pole contactor. Field power is connected directly to the terminal lugs on the line side of the contactor. 3-phase models that are factory equipped with a crankcase heater have auxiliary contacts on the contactor that de-energize the contactor when the system is running to maximize efficiency.

7.6 Compressor/ Fan Motor Capacitor

Single-phase models with PSC fan motors utilize a dual capacitor for both the compressor and fan motor. Single-phase models with ECM outdoor motors utilize a single capacitor for the compressor. 3-phase models with PSC motors utilize a single capacitor for the fan motor. 3-phase models with 3-phase fan motors do not require a capacitor.

7.7 Reversing Valve

All models are equipped with a reversing valve that allows the system to reverse the refrigeration cycle to provide either cooling or heating. The reversing valve is energized in the heating mode and is energized anytime the thermostat is set to the “Heat” mode. The outdoor unit has a thermostat pigtail that must be electrically connected to the “B” terminal on the thermostat.

7.8 Charge Compensator

Some models are equipped with a charge compensator that stores a predetermined amount of refrigerant in either the heating or cooling mode so the refrigerant charge is optimized in both the cooling and heating modes. The charge compensator is the cylindrical device with larger tubes coming out each end and a 3/8” [9.53 mm] diameter tube on one end that is connected to the liquid line near the liquid service valve.

7.0 COMPONENTS & CONTROLS

7.9 Thermal Expansion Valve (TXV)

All models except the (-)P14**AJP models are equipped with a properly sized thermal expansion valve (TXV) to meter the refrigerant flow and provide a consistent superheat level in the heating mode. The TXV's all have an internal check valve that

opens in the cooling mode to provide unrestricted flow. All TXV's have a 10% bleed rate to help eliminate "hammering" in the off cycle that sometimes occurs when non-bleed TXV's are used on both the indoor coil and outdoor heat pump unit.

7.10 Flow Check Distributor/Piston Assembly

All (-)P14**AJP models are equipped with a properly sized "Flow Check" distributor/piston assembly (fixed orifice) to meter the refrigerant flow in the

heating mode. The piston unseats and provides unrestricted flow in the cooling mode.

7.11 Suction Line Accumulator

All (-)P14**AJP models are equipped with a suction line accumulator to prevent liquid refrigerant from returning to the compressor, thus protecting the

compressor during system start-up, defrost, and extremely cold conditions due to the fixed orifice metering device that is used on these models.

7.12 Compressor Crankcase Heater (CCH)

While scroll compressors usually do not require crankcase heaters, there are instances when a heater should be added. Refrigerant migration during the off cycle can result in a noisy start up. Add a crankcase heater to minimize refrigeration migration, and to help eliminate any start up noise or bearing "wash out."

A crankcase heater is to be located near the bottom of the compressor shell. Its purpose is to drive refrigerant from the compressor shell during long cycles, thus preventing damage to the compressor during start-up.

NOTE: The installation of a crankcase heater is recommended if the system charge exceeds the values in the table below. Some models come with a crankcase heater factory installed as indicated by an asterisk.

At initial start-up or after extended shutdown periods, make sure the heater is energized for at least 12 hours before the compressor is started. (Disconnect switch on and wall thermostat off.)

MAXIMUM SYSTEM CHARGE VALUES	
Model Size	Charge Limit Without Crankcase Heater*
(-)P1418C	9.6 lbs. [4.4 kg]
(-)P1424A	9.6 lbs. [4.4 kg]
(-)P1430A	9.6 lbs. [4.4 kg]
(-)P1436A	9.6 lbs. [4.4 kg]
(-)P1442C	12 lbs. [5.4 kg]
(-)P1448A	12 lbs. [5.4 kg]
* (-)P1460B	* 12 lbs. [5.4 kg]
(-)P1418G	9.6 lbs. [4.4 kg]
(-)P1424F	9.6 lbs. [4.4 kg]
(-)P1430F	9.6 lbs. [4.4 kg]
(-)P1436F	9.6 lbs. [4.4 kg]
(-)P1442F	12 lbs. [5.4 kg]
* (-)P1442G	* 12 lbs. [5.4 kg]
* (-)P1448F	* 12 lbs. [5.4 kg]
* (-)P1460F	* 12 lbs. [5.4 kg]
(-)P1418AJP	9.6 lbs. [4.4 kg]
(-)P1424AJP	9.6 lbs. [4.4 kg]
(-)P1430AJP	9.6 lbs. [4.4 kg]
(-)P1436AJP	9.6 lbs. [4.4 kg]
(-)P1436BJP	9.6 lbs. [4.4 kg]
(-)P1442AJP	12 lbs. [5.4 kg]
(-)P1448AJP	12 lbs. [5.4 kg]
(-)P1460AJP	12 lbs. [5.4 kg]

MAXIMUM SYSTEM CHARGE VALUES	
Model Size*	Charge Limit Without Crankcase Heater*
(-)P1518C	9.6 lbs. [4.4 kg]
(-)P1524B	9.6 lbs. [4.4 kg]
(-)P1530B	9.6 lbs. [4.4 kg]
(-)P1536A	9.6 lbs. [4.4 kg]
(-)P1542A	12 lbs. [5.4 kg]
* (-)P1542B	* 12 lbs. [5.4 kg]
* (-)P1548A	* 12 lbs. [5.4 kg]
* (-)P1560A	* 12 lbs. [5.4 kg]

*Crankcase Heater Factory Installed.

7.0 COMPONENTS & CONTROLS

7.13 High and Low Pressure Controls

Standard on (-)P14 and (-)P15: These controls keep the compressor from operating in pressure ranges which can cause damage to the compressor. Both controls are in the low-voltage control circuit.

The high-pressure control (HPC) is an automatic-reset which opens near 610 PSIG [4206 kPa] and closes near 420 PSIG [2896 kPa].

The low-pressure control (LPC) is an automatic-reset which opens near 15 PSIG [103 kPa] and closes near 40 PSIG [276 kPa].

⚠CAUTION: The compressor has an internal overload protector. Under some conditions, it can take up to 2 hours for this overload to reset. Make sure overload has had time to reset before condemning the compressor.

7.14 Compressor Hard Start Components

Start components are not usually required with the scroll compressors used in heat pumps, but are available for low line voltage applications and where start components are desirable to reduce

light dimming. Hard start components must be field installed and are available through Rheem Parts or Ruud Parts.

7.15 Discharge Line Muffler

All models are equipped with a discharge line muffler to help absorb discharge pulses in the vapor line in the heating mode that can result in

unwanted noise and vibration inside the building structure.

8.0 ACCESSORIES

⚠WARNING: Turn off electric power at the fuse box or service panel before making any electrical connections while installing accessories. Failure to do so can result in electrical shock, severe personal injury, or death.

8.1 Compressor Time Delay

The time delay (TDC) is in the low voltage control circuit. When the compressor shuts off due to a power failure or thermostat operation, this control keeps it off at least 5 minutes before the next cycle can begin.

8.2 Low Ambient Control

This component senses compressor head pressure and shuts the heat pump fan off when the head pressure drops to approximately 250 PSIG. This allows the unit to build a sufficient head pressure at lower outdoor ambient (down to 0°F [-18°C]) in order to maintain system balance and capacity. Low ambient control should be used on all equipment frequently operated below 70°F [21°C] ambient. Part No. **RXAD-A08**

8.3 Compressor Hard Start Kit

1.5–5.0 Ton 208/230V Single Phase Models:
Part No. **SK-A1**

8.4 Compressor Crankcase Heater

1.5–3.0 Ton 208/230V Single and 3-Phase Models: Part No. **44-101884-08** (w/outdoor temp. thermostat) or **44-17402-44** (w/o outdoor temp. thermostat)

3.0 Ton 460V 3-Phase Models:

Part No. **44-101884-09** (w/outdoor temp. thermostat) or **44204** (w/o outdoor temp. thermostat)

3.5–5.0 Ton 208/230V Single and 3-Phase Models: Part No. **44-103663-13** (w/outdoor temp.

thermostat) or **44-17402-45** (w/o outdoor temp. thermostat)

3.5–5.0 Ton 460V 3-Phase Models:

Part No. **44-101884-06** (w/outdoor temp. thermostat) or **44-17402-46** (w/o outdoor temp. thermostat)

8.5 Heat Pump Thermostat Warning Light

This component senses a compressor lock out and tells the thermostat service light to come on. This will let the homeowner know that service is needed on the system. Part No. **RXPX-D01**

NOTE: Warning light on thermostat will come on during a 5 minute compressor time delay and for 5 seconds during defrost while the compressor is off. Homeowner should only be concerned if light stays on for more than 5 minutes.

8.6 Remote Outdoor Temperature Sensor

This is a kit that has a longer remote sensor that can be installed away from the outdoor unit for better thermostat temperature display.

8.7 Compressor Sound Enclosure

1.5–3.0 Ton Models:
Part No. **68-23427-26**

3.5–5.0 Ton Models:
Part No. **68-23427-25**

9.0 DIAGNOSTICS & TROUBLESHOOTING

9.1 Defrost Control Diagnostic Codes

LED 1	LED 2	Control Board Status
OFF	OFF	No Power
ON	ON	Coil Sensor Failure
OFF	ON	Ambient Sensor Failure
FLASH	FLASH	Normal
OFF	FLASH	Low Pressure Lockout (short test pins to reset)
FLASH	OFF	High Pressure Lockout (short test pins to reset)
ON	FLASH	Low Pressure Control Open
FLASH	ON	High Pressure Control Open
ON	OFF	In Defrost Mode
Alternate Flashing		5 Minute Time Delay

9.2 Outdoor Ambient and Coil Sensor Temperature vs. Resistance Table

Degrees C	Degrees F	Ohms
-20	-4	96,974
-10	14	55,298
0	32	32,650
10	50	19,903
20	68	12,493
25	77	10,000
30	86	8,056
40	104	5,324

9.0 DIAGNOSTICS & TROUBLESHOOTING

9.3 Electrical Checks Flowchart

THERMOSTAT CALL FOR OPERATION, NO OPERATION

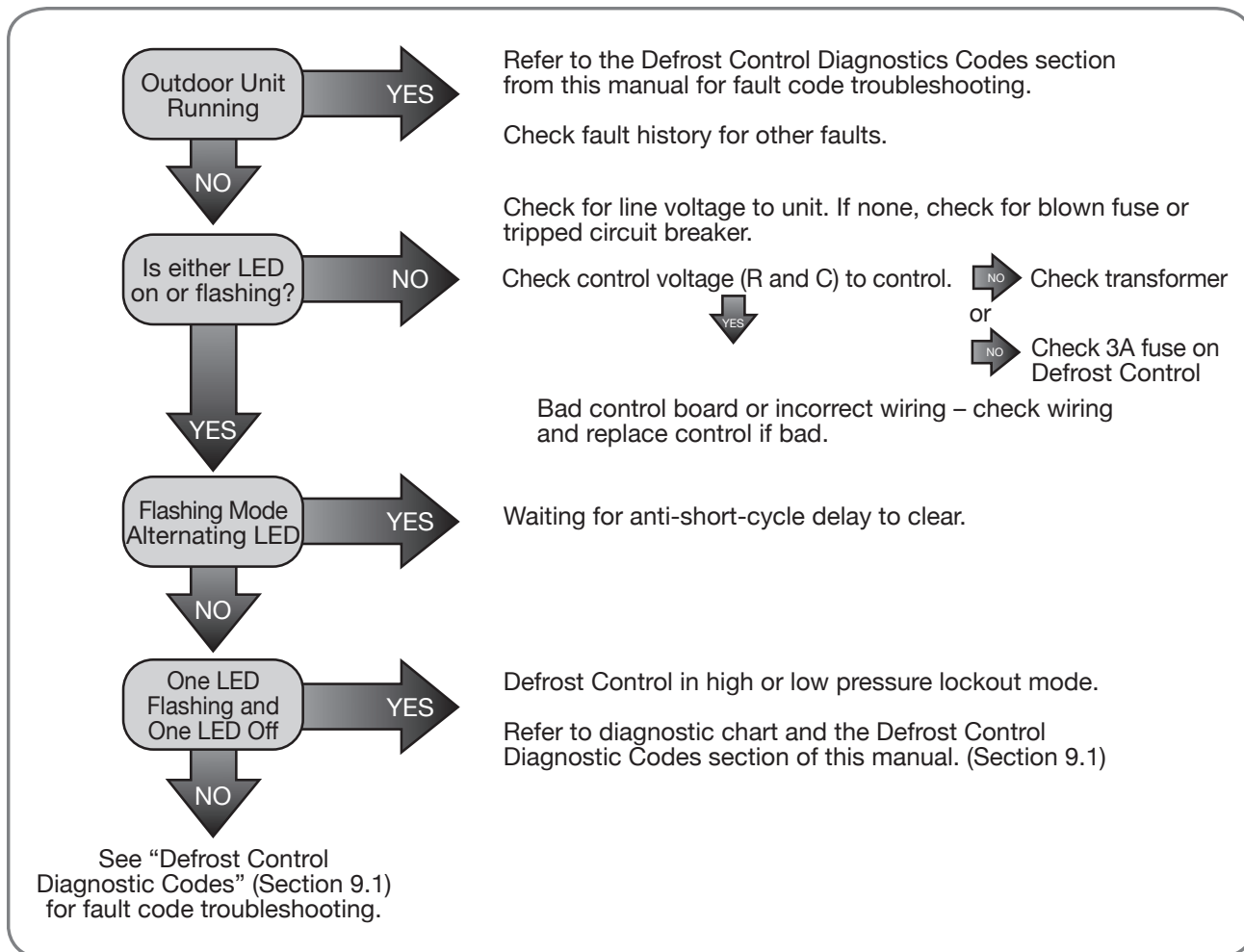

9.0 DIAGNOSTICS & TROUBLESHOOTING

9.4 Cooling Mechanical Checks Flowchart

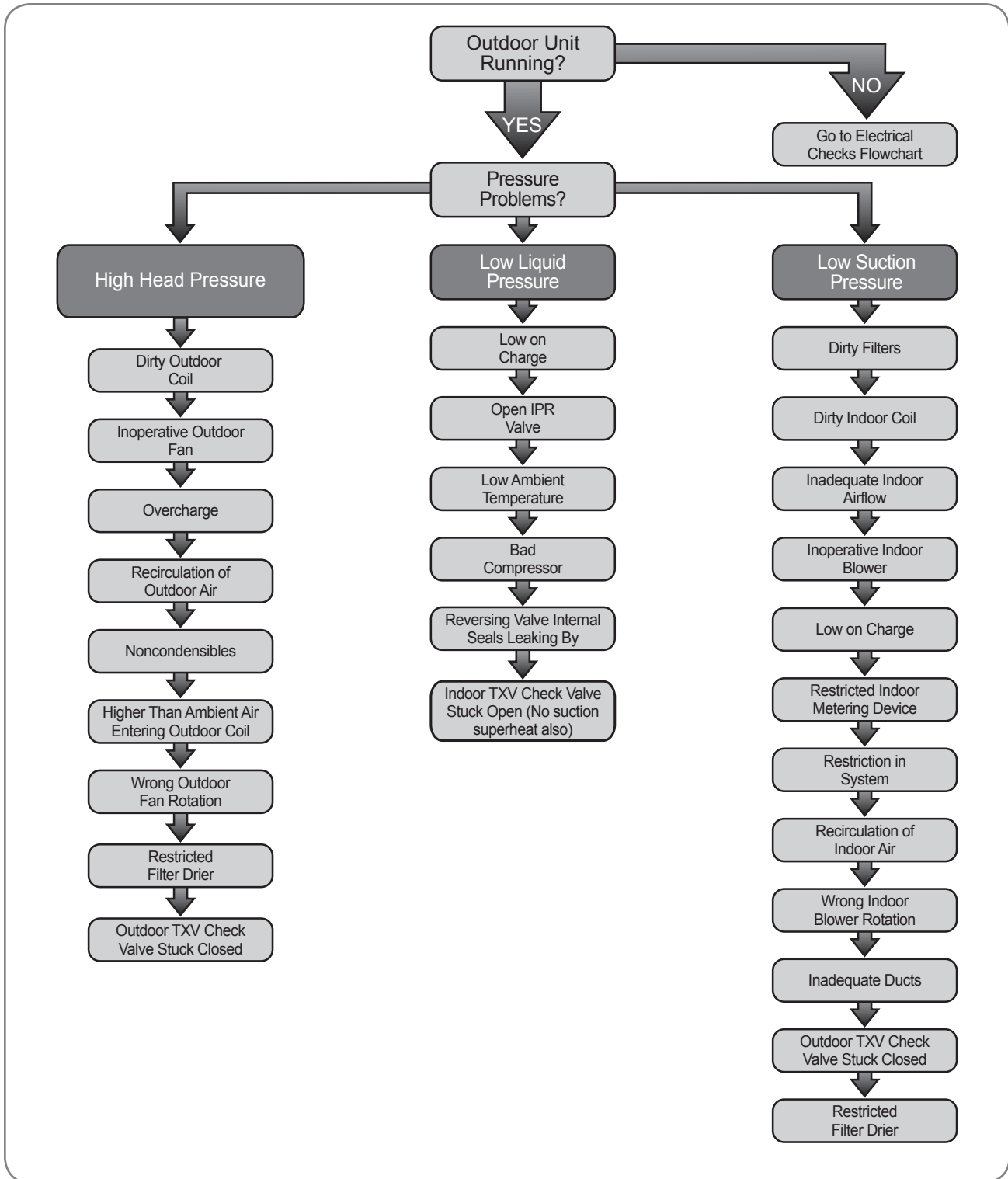

9.0 DIAGNOSTICS & TROUBLESHOOTING

9.5 Heating Mechanical Checks Flowchart

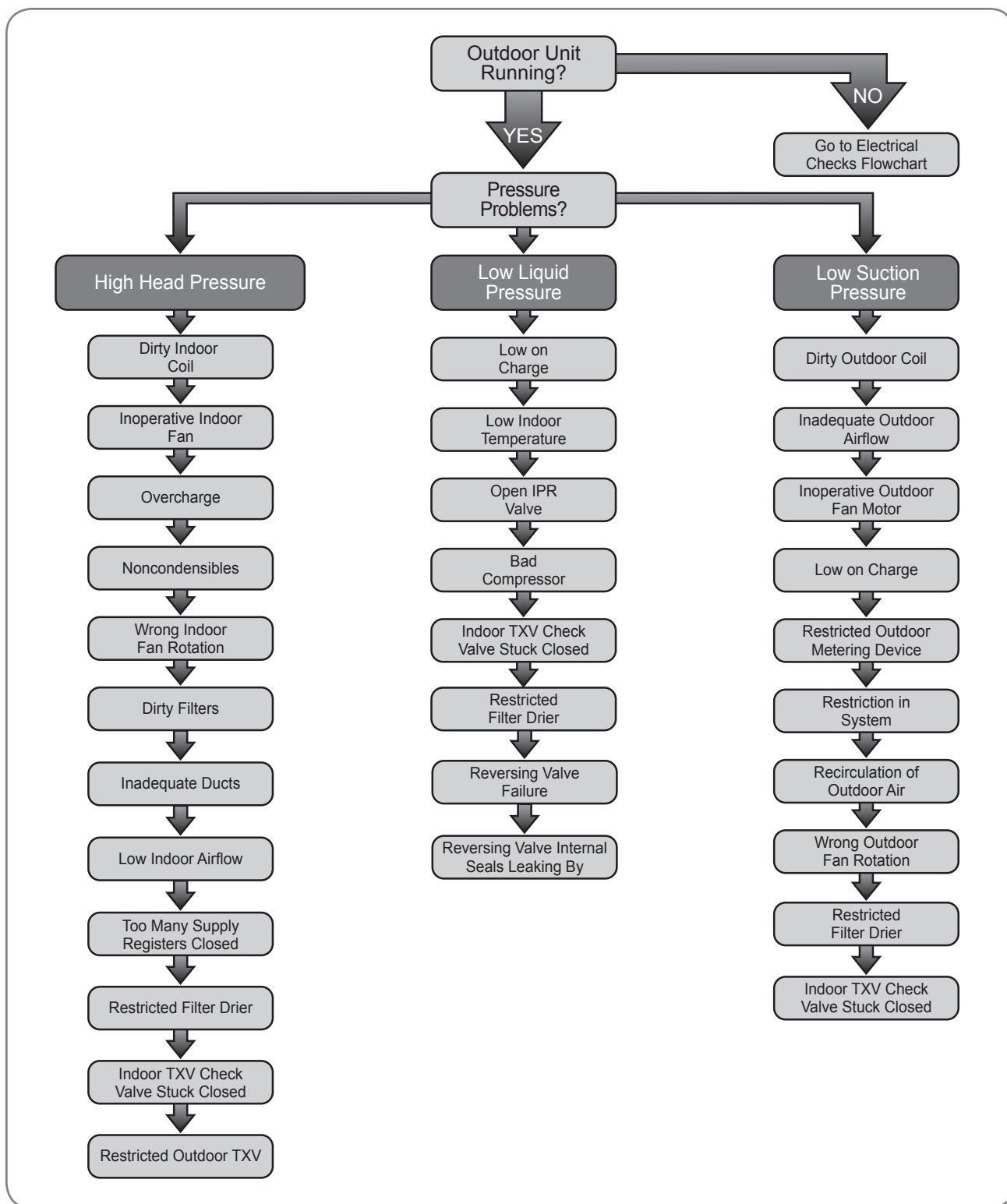

9.0 DIAGNOSTICS & TROUBLESHOOTING

9.6 Defrost Mechanical Checks Flowchart

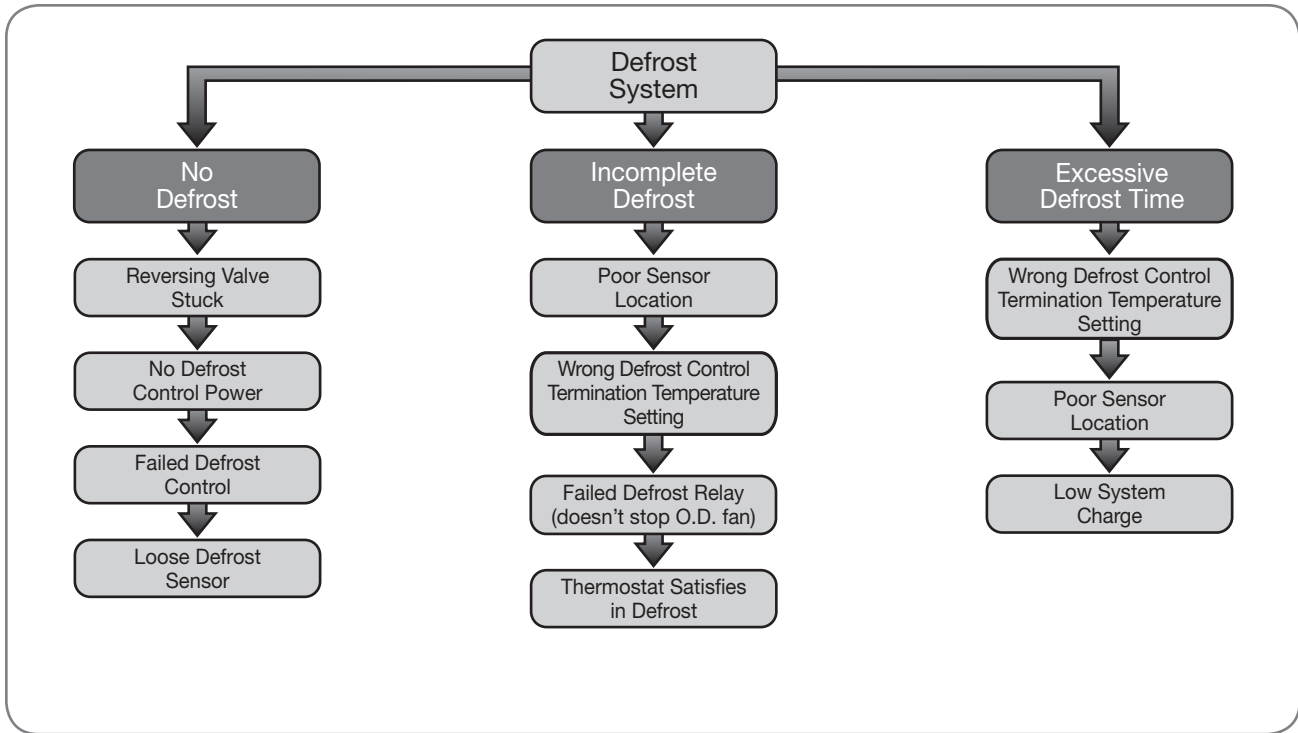

Diagnosics

9.7 Defrost Test Mode (See Section 7.1)

9.0 DIAGNOSTICS & TROUBLESHOOTING

9.8 General Troubleshooting Guide

⚠️WARNING: Disconnect all power to unit before servicing. Contactor may break only one side. Failure to shut off power can cause electrical shock resulting in personal injury or death.

SYMPTOM	POSSIBLE CAUSE	REMEDY
Unit will not run	<ul style="list-style-type: none"> Power off or loose electrical connection Thermostat out of calibration – set too low or high Defective control board Blown fuses/tripped breaker Transformer defective High-pressure control lock-out Low pressure control lock-out Miswiring of thermostat 	<ul style="list-style-type: none"> Check for correct voltage at line voltage connections in condensing unit. Reset. Check control board diagnostic codes. Replace fuses/reset breaker. Check wiring. Replace transformer. Reset by cycling power to unit. Also see high head pressure remedy. The high-pressure control opens at 610 PSIG [420 kPa]. Reset by cycling power to unit. Low refrigerant charge due to leak. Check refrigerant charge and check for leaks. Check thermostat wiring.
Outdoor fan runs, compressor doesn't	<ul style="list-style-type: none"> Run or start capacitor defective Start relay defective Loose connection Compressor stuck, grounded or open motor winding, open internal overload. Low-voltage condition 	<ul style="list-style-type: none"> Replace. Replace. Check for correct voltage at compressor. Check and tighten all connections. Wait at least 3 hours for overload to reset. If still open, replace the compressor. Add start kit components.
Insufficient cooling	<ul style="list-style-type: none"> Improperly sized unit Improper indoor airflow Incorrect refrigerant charge Air, noncondensibles, or moisture in system Restricted refrigerant circuit 	<ul style="list-style-type: none"> Recalculate load. Check. Should be approximately 400 CFM [189 L/s] per ton. Charge per procedure attached to unit service panel. Recover refrigerant. Evacuate and recharge. Add filter drier. Locate restriction and clear.
Compressor short cycles	<ul style="list-style-type: none"> Incorrect voltage Defective overload protector Refrigerant undercharge or overcharge (HPC or LPC cycling) 	<ul style="list-style-type: none"> At compressor terminals, voltage must be $\pm 10\%$ of nameplate marking when unit is operating. Replace. Check for correct voltage. Adjust charge per charging chart.
Registers sweat	<ul style="list-style-type: none"> Low indoor airflow 	<ul style="list-style-type: none"> Increase speed of blower or reduce restriction. Replace air filter.
High head, low vapor pressures	<ul style="list-style-type: none"> Restriction in liquid line, expansion device, or filter drier Bad TXV 	<ul style="list-style-type: none"> Remove or replace defective component. Replace TXV.
High head, high or normal vapor pressure – Cooling mode	<ul style="list-style-type: none"> Dirty outdoor coil Refrigerant overcharge Outdoor fan not running Air or noncondensibles in system 	<ul style="list-style-type: none"> Clean coil. Correct system charge. Repair or replace. Recover refrigerant. Evacuate and recharge.
Low head, high vapor pressures	<ul style="list-style-type: none"> Bad TXV Bad compressor Reversing valve leaking by 	<ul style="list-style-type: none"> Replace TXV. Replace compressor. Replace reversing valve
Low vapor, iced indoor coil	<ul style="list-style-type: none"> Low indoor airflow Operating below 65°F [18°C] outdoors Moisture in system Low refrigerant charge 	<ul style="list-style-type: none"> Increase speed of blower or reduce restriction. Replace air filter. Add Low Ambient Kit. Recover refrigerant. Evacuate and recharge. Add filter drier. Check refrigerant charge and check for leaks.
High vapor pressure	<ul style="list-style-type: none"> Excessive load Defective compressor 	<ul style="list-style-type: none"> Recheck load calculation. Replace.
Fluctuating head and vapor pressures	<ul style="list-style-type: none"> TXV hunting Air or noncondensibles in system 	<ul style="list-style-type: none"> Check TXV bulb clamp. Check air distribution on coil. Replace TXV. Recover refrigerant. Evacuate and recharge.
Gurgle or pulsing noise at expansion device or liquid line	<ul style="list-style-type: none"> Air or noncondensibles in system Undercharged system 	<ul style="list-style-type: none"> Recover refrigerant. Evacuate and recharge. Adjust charge per charging chart.

9.0 DIAGNOSTICS & TROUBLESHOOTING

9.9 Service Analyzer Charts

COMPRESSOR OVERHEATING			
SYMPTOM	POSSIBLE CAUSE	CHECK/REMEDY	
High superheat (greater than 15°F [8.3°C] at coil)	Low charge	Check system charge.	
	Faulty metering device	Restricted cap tube, TXV	
		Power element superheat out of adjustment internally	
		Foreign matter stopping flow	
	High internal load	Hot air (attic) entering return	
		Heat source on; miswired or faulty control	
	Restriction in liquid line	Drier plugged.	
		Line kinked.	
	Low head pressure	Low charge	
		Operating in low ambient temperatures	
Vapor or liquid line subjected to high heat source	Hot attic		
	Hot water line		
Low line voltage	Loose wire connections	Check wiring.	
	Power company problem, transformer	Report problem.	
	Undersized wire feeding unit	Correct and complete diagnosis.	
High line voltage	Power company problem	Report problem.	
High head pressure	Overcharge	Check system charge.	
	Dirty heat pump coil	Clean coil.	
	Faulty or wrong size heat pump fan motor	Check capacitor. Replace fan motor.	
	Faulty fan blade or wrong rotation	Replace fan blade.	
		Replace with correct rotation motor.	
	Recirculation of air	Correct installation.	
	Additional heat source	Check for dryer vent near unit.	
		Check for recirculation from other equipment.	
Noncondensibles	Recover refrigerant. Evacuate and recharge system.		
Equipment not matched	Correct mismatch.		
Short cycling of com- pressor	Cycling or faulty pressure control	Check pressures and address cause of high or low pres- sure. Replace pressure control if faulty.	
	Loose wiring	Check unit wiring.	
	Thermostat	Located in supply air stream	
		Differential setting too close	
		Customer misuse	
	TXV restricted	Internal foreign matter	
		Power element failure	
		TXV too small	
		Equilizer tube plugged	
	Distributor tube restricted	Restricted with foreign matter	
Kinked			
Inside diameter reduced from previous compressor failure			

9.0 DIAGNOSTICS & TROUBLESHOOTING

9.9 Service Analyzer Charts (cont.)

COMPRESSOR OVERHEATING (cont.)		
SYMPTOM	POSSIBLE CAUSE	CHECK OR REMEDIES
Short cycling of compressor (cont.)	Low charge	Check system charge.
	Low evaporator airflow	Dirty coil
		Dirty filter
		Duct too small or restricted
	Faulty run capacitor	Replace.
Faulty internal overload	Replace compressor.	
Faulty Compressor Valves or scrolls	Fast equalization/Low pressure difference	Replace compressor and examine system to locate reason.
ELECTRICAL		
SYMPTOM	POSSIBLE CAUSE	CHECK OR REMEDIES
Voltage present on load side of compressor contactor and compressor won't run	Compressor start components	Check start capacitor.
		Check potential relay.
	Run capacitor	Check with ohmmeter
	Internal overload	Allow time to reset.
Voltage present on line side of compressor contactor only	Compressor windings	Check for correct ohms.
	Thermostat	Check for control voltage to contactor coil.
	Compressor control circuit	High-pressure switch
		Low-pressure switch
		Ambient thermostat
Solid-state protection control or internal thermal sensors		
Compressor timed off/on control or interlock		
No voltage on line side of compressor contactor	Blown fuses or tripped circuit breaker	Check for short in wiring or unit.
	Improper wiring	Recheck wiring diagram.
Improper voltage	High voltage	Wrong unit
		Power supply problem
	Low voltage	Wrong unit
		Power supply problem
		Wiring undersized
	Loose connections	
Single Phasing (3 phase)	Check incoming power and fusing.	
FLOODED STARTS		
SYMPTOM	POSSIBLE CAUSE	CHECK OR REMEDIES
Liquid in the compressor shell	Faulty or missing crankcase heater	Replace or add crankcase heater.
Too much liquid in system	Incorrect piping	Check piping guidelines.
	Overcharge	Check and adjust charge.

9.0 DIAGNOSTICS & TROUBLESHOOTING

9.9 Service Analyzer Charts (cont.)

CONTAMINATION		
SYMPTOM	POSSIBLE CAUSE	REMEDY
Moisture	Poor evacuation on installation or during service	In each case, the cure is the same. Recover refrigerant. Add filter drier, evacuate, and recharge.
High head pressure	Noncondensibles air	Reclaim refrigerant, evacuate, and recharge.
Unusual head and suction readings	Wrong refrigerant or mixed refrigerants	Reclaim refrigerant, evacuate, and recharge.
Foreign matter – copper filings	Copper tubing cuttings	Reclaim refrigerant, evacuate, and recharge.
Copper oxide	Dirty copper piping or nitrogen not used when brazing	Reclaim refrigerant, evacuate, and recharge.
Welding scale	Nitrogen not used during brazing	Reclaim refrigerant, evacuate, and recharge.
Soldering flux	Adding flux before seating copper partway	Reclaim refrigerant, evacuate, and recharge.
Excess soft solder	Wrong solder material	Reclaim refrigerant, evacuate, and recharge.
LOSS OF LUBRICATION		
SYMPTOM	POSSIBLE CAUSE	REMEDY
Compressor failures	Vapor line tubing too large	Reduce pipe size to improve oil return.
Low suction pressure	Low charge	Check system charge.
	Refrigerant leaks	Repair and recharge.
Cold, noisy compressor – Slugging	Dilution of oil with refrigerant	Observe piping guidelines.
Noisy compressor	Migration	Check crankcase heater.
Cold, sweating compressor	Flooding	Check system charge.
Low load	Reduced airflow	Dirty filter
		Dirty coil
		Wrong duct size
		Restricted duct
	Thermostat setting	Advise customer.
Short cycling of compressor	Cycling or faulty high or low-pressure control	Check pressure and address cause of high or low pressure. Replace control if faulty.
	Loose wiring	Check all control wires.
	Thermostat	In supply air stream, out of calibration Customer misuse
SLUGGING		
SYMPTOM	POSSIBLE CAUSE	REMEDY
On start-up	Incorrect piping	Review pipe size guidelines.
TXV hunting when running	Faulty TXV	Replace TXV.

9.0 DIAGNOSTICS & TROUBLESHOOTING

9.9 Service Analyzer Charts (cont.)

FLOODING		
SYMPTOM	POSSIBLE CAUSE	REMEDY
Poor system control using a TXV	Loose sensing bulb	Secure the bulb and insulate.
	Bulb in wrong location	Relocate bulb.
	Wrong size TXV	Use correct replacement.
	Improper superheat setting (less than 5°F [2.8°C])	Replace TXV.
THERMOSTATIC EXPANSION VALVE (TXV)		
SYMPTOM	POSSIBLE CAUSE	REMEDY
High Superheat, Low Suction Pressure (superheat over 15°F [8.3°C])	Moisture freezing and blocking valve	Recover charge, install filter-drier, evacuate system, recharge.
	Dirt or foreign material blocking valve	Recover charge, install filter-drier, evacuate system, recharge.
	Low refrigerant charge	Correct the charge.
	Vapor bubbles in liquid line	Remove restriction in liquid line. Correct the refrigerant charge.
		Remove noncondensable gases.
		Size liquid line correctly.
	Misapplication of internally equalized valve	Use correct TXV.
	Plugged external equalizer line	Remove external equalizer line restriction.
	Undersized TXV	Replace with correct valve.
	Loss of charge from power head sensing bulb	Replace power head or complete TXV.
Charge migration from sensing bulb to power head (Warm power head with warm, wet cloth. Does valve operate correctly now?)	Ensure TXV is warmer than sensing bulb.	
Valve feeds too much refrigerant, with low superheat and higher than normal suction pressure	Moisture causing valve to stick open.	Recover refrigerant, replace filter-drier, evacuate system, and recharge.
	Dirt or foreign material causing valve to stick open	Recover refrigerant, replace filter drier, evacuate system, and recharge.
	TXV seat leak (a gurgling or hissing sound is heard AT THE TXV during the off cycle, if this is the cause). NOT APPLICABLE TO BLEED PORT VALVES.	Replace the TXV.
	Oversized TXV	Install correct TXV.
	Incorrect sensing bulb location	Install bulb with two mounting straps, in 2:00 or 4:00 position on suction line, with insulation.
	Low superheat adjustment	Replace TXV.
	Incorrectly installed, or restricted external equalizer line	Remove restriction, or relocate external equalizer.

9.0 DIAGNOSTICS & TROUBLESHOOTING

9.9 Service Analyzer Charts (cont.)

THERMOSTATIC EXPANSION VALVES (cont.)		
SYMPTOM	POSSIBLE CAUSE	REMEDY
Compressor flood back upon start-up	Refrigerant drainage from flooded evaporator	Install trap riser to the top of the evaporator coil.
	Inoperable crankcase heater or crankcase heater needed	Replace or add crankcase heater.
Superheat is low to normal with low suction pressure	Unequal evaporator circuit loading	Ensure airflow is equally distributed through evaporator.
		Check for blocked distributor tubes.
	Low load or airflow entering evaporator coil	Ensure blower is moving proper air-flow.
		Remove/Correct any airflow restriction.
Superheat and suction pressure fluctuate (valve is hunting)	TXV is oversized	Install correct TXV.
	Sensing bulb is affected by liquid refrigerant or refrigerant oil flowing through suction line	Relocate sensing bulb in another position around the circumference of the suction line.
	Unequal refrigerant flow through evaporator circuits	Ensure sensing bulb is located properly.
		Check for blocked distributor tubes.
Moisture freezing and partially blocking TXV	Recover refrigerant, change filter-drier, evacuate system, and recharge.	
Valve does not regulate at all	External equalizer line not connected or line plugged	Connect equalizer line in proper location, or remove any blockage.
	Sensing bulb lost its operating charge	Replace TXV.
	Valve body damaged during soldering or by improper installation	Replace TXV.

9.0 DIAGNOSTICS & TROUBLESHOOTING

9.10 Troubleshooting Tips

COOLING MODE TROUBLESHOOTING TIPS					
SYSTEM PROBLEM	INDICATORS				
	DISCHARGE PRESSURE	SUCTION PRESSURE	SUPERHEAT Normal: 5°–15°F [2.8° – 8.3°C]	SUBCOOLING Normal: See Charging Chart	COMPRESSOR AMPS
Overcharge	High	High	Low	High	High
Undercharge	Low	Low	High	Low	Low
Liquid Restriction (Filter Drier)	Low	Low	High	High	Low
Low Indoor Airflow	Low	Low	Low	Low	Low
Dirty Outdoor Coil	High	High	Low	Low	High
Low Outdoor Ambient Temperature	Low	Low	High	High	Low
Inefficient Compressor	Low	High	High	High	Low
Indoor TXV Sensing Bulb Charge Lost	Low	Low	High	High	Low
Poorly Insulated Indoor Sensing Bulb	High	High	Low	Low	High

HEATING MODE TROUBLESHOOTING TIPS					
SYSTEM PROBLEM	INDICATORS				
	DISCHARGE PRESSURE	SUCTION PRESSURE	SUPERHEAT Normal: 5°–15°F [2.8° – 8.3°C]	SUBCOOLING Normal: See Charging Chart	COMPRESSOR AMPS
Overcharge	High	High	OK	High	High
Undercharge	Low	Low	OK or High	Low	Low
Liquid Restriction (Filter Drier)	Low	Low	High	High	Low
Low Outdoor Airflow	Low	Low	Low	Low	Low
Dirty Indoor Coil	High	High	Low	Low	High
Low Indoor Ambient Temperature	Low	Low	OK	High	Low
Inefficient Compressor	Low	High	High	High	Low
Outdoor TXV Sensing Bulb Charge Lost	Low	Low	High	High	Low
Poorly Insulated Outdoor Sensing Bulb	High	High	Low	Low	High

10.0 OUTDOOR UNIT MAINTENANCE



10.1 Outdoor Coil Cleaning

The outdoor fan draws air across the coil during operation which results in contaminants collecting on and between the aluminum fins. These contaminants restrict the air-flow through the coil resulting in reduced capacity and efficiency and increases the temperature of the components that can reduce their life. Therefore, it is recommended that the outdoor coil be cleaned at least annually by a qualified service technician using a non-corrosive coil cleaner and low pressure water hose sprayer. Care must be taken not to damage or flatten out the fins by spraying the fins from

an angle. Washing from the top of the coil down from the inside out is the most effective method of cleaning the coil. The exterior louver panels and unit top are easily removable to facilitate the coil cleaning task.

WARNING: Disconnect electrical power to the unit before removing the top panel or any electrical panel as the fan motor could start at any time and live electrical connections will be exposed.



10.2 Cabinet Cleaning and Care

Annual cleaning of the exterior cabinet is recommended using a mild detergent, water, and cloth/sponge to remove dust, mold, and potentially corrosive contaminants that have collected on the cabinet. It is also recommended to apply a good quality automotive wax to the painted metal cabinet parts annually to protect the finish and to restore the gloss of the paint. Do not apply wax to the plastic parts.



10.3 Motor Lubrication

The bearings in the outdoor motor are pre-lubricated by the motor manufacturer and do not have oiling ports. The motor will run for an indefinite period of time without additional lubrication.



10.4 Replacement Parts

Any replacement part used to replace parts originally supplied on equipment must be the same as or an approved alternate to the original part supplied. The manufacturer will not be responsible for replacement parts not designed to physically fit or operate within the design parameters the original parts were selected for.

11.0 WIRING DIAGRAMS

11.2 208/230V Single-Phase with ECM Motor

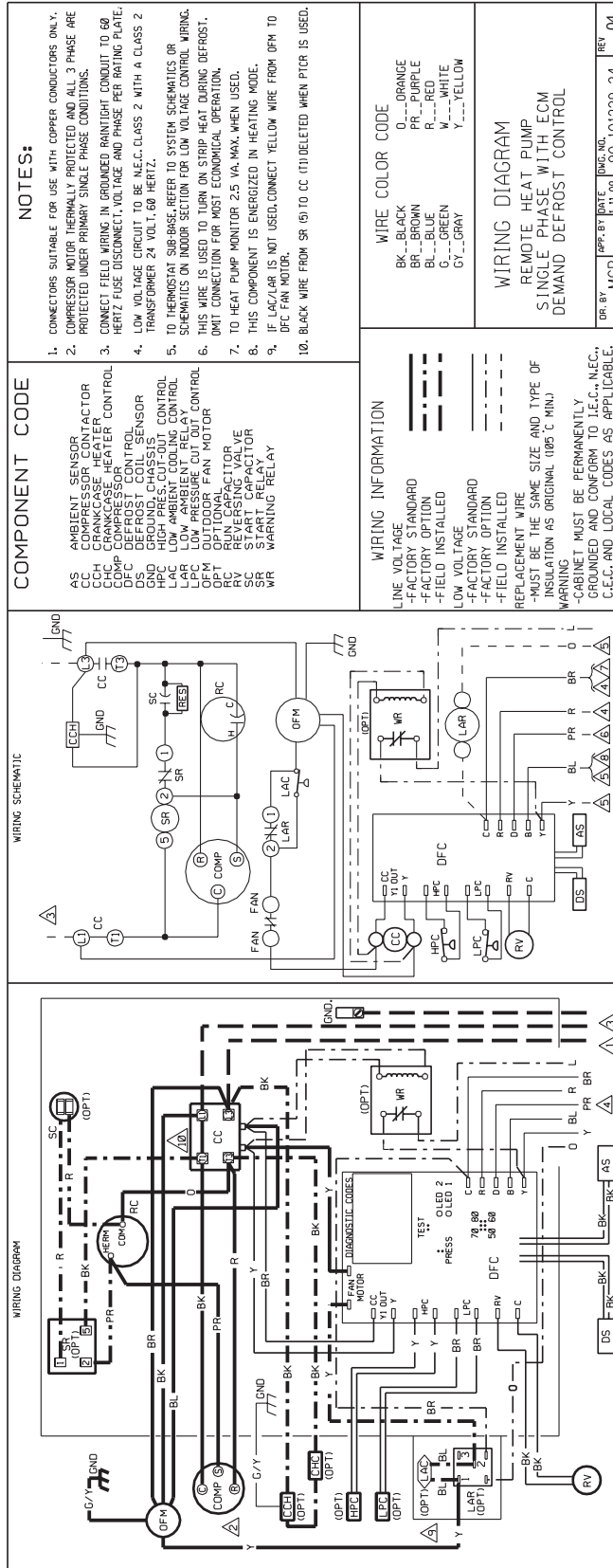

11.0 WIRING DIAGRAMS

11.3 208/230V 3-Phase with PSC Motor

WIRING DIAGRAM
DIAGRAMA DE CABLEADO

WIRING SCHEMATIC
ESQUEMA DE CABLEADO

WIRING SCHEMATIC
ESQUEMA DE CABLEADO

COMPONENT CODE
CÓDIGO DE LOS COMPONENTES

- CC Compressor/Contactor del compresor
- CCF Compressor/Contactor del capacitor
- COMP Compressor/Compresor
- GND Ground/Chasis/Tierra del chasis
- HOT High voltage sensor/Sensor de alta tensión
- HPC High pressure cut out/Control de interrupción por alta presión
- LAC Low ambient cooling control/Control de límite de temperatura ambiente
- LPC Low pressure cut out control/Control de interrupción por baja presión
- OFM Optional Fan/Motor del ventilador exterior
- OPT Optional/Opcional
- RC Run capacitor/Capacitor de marcha
- SC Start capacitor/Capacitor de arranque
- SR Start relay/Relé de arranque
- TDC Time delay control/Control del tiempo de retardo

NOTES △

OBSERVACIONES

1. Connectors suitable for use with copper conductors only / Los conectores se pueden usar con conductores de cobre.
2. Compressor Motor thermally protected and all 3 phase are protected under primary single phase conditions. / El motor del compresor posee protección térmica y a tres fases están protegidas por un interruptor de sobrecorriente.
3. Disconnect the disconnect voltage and phase per rating plate / Ejecte la instalación con tuberías estanca para uso eléctrico conectada a tierra. La alimentación se debe conectar a un accesorio con tuberías y la tubería de salida del suministro debe cumplir los requisitos de la placa de características del equipo.
4. Low voltage circuit to be I.E.C. Class 2 with a Class 2 transformer 24 volt, 50 or 60 hertz.
5. To thermostat sub-base refer to system schematics or schematic on motor section for low voltage control wiring. / Para el sub-base de termostato consulte los esquemas de cableado de control de baja tensión de la sección interior.

WIRING INFORMATION
INFORMACIÓN SOBRE EL CABLEADO

- Line Voltage / Tensión de alimentación
- Field installed / Instalación en el lugar
- Factory option / Opcional de fábrica
- Factory standard / Estándar de fábrica
- Factory option / Opcional de fábrica
- Equipment Wire / Hacer uso de cables de equipo
- Must be the same size and type of insulation as original (105°C min.)
- Conductor must be permanently grounded and conform to I.E.C., N.E.C., C.E.C.
- El gabinete debe estar conectado a tierra de forma permanente y de acuerdo a la norma I.E.C., European, N.E.C. (E.U.), C.E.C. (Canadá) y los códigos locales que sean de aplicación.

WIRE COLOR CODE
CÓDIGO DE COLORES DEL CABLEADO

- BK BLACK / NEGRO
- OR ORANGE / NARANJA
- BR BROWN / MARRÓN
- PR PURPLE / MORADA
- Y YELLOW / AMARILLO
- W WHITE / BLANCO
- GR GREEN / VERDE
- GT GRAY / GRIS

WIRING DIAGRAM
DIAGRAMA ELÉCTRICO DE CABLEADO

REMOTE HEAT PUMP, 3 PHASE
BOMBA DE CALOR REMOTA, TRIPLE FASE

DR. BY JHB

DATE 5-1-13

DWG. NO. 90-101229-30

REV 02

11.0 WIRING DIAGRAMS

11.4 208/230V 3-Phase with ECM Motor

<p style="text-align: center;">WIRING SCHEMATIC ESQUEMA DE CABLEADO</p>	<p style="text-align: center;">WIRING DIAGRAM DIAGRAMA DE CABLEADO</p>	<p style="text-align: center;">NOTES OBSERVACIONES</p> <ol style="list-style-type: none"> 1. Connectors suitable for use with copper conductors only. / Los conectores se pueden usar únicamente con conductores de cobre. 2. The motor is designed for use with all 3 phases and must be connected to all 3 phases in order to operate properly. / El motor del compresor posee protección térmica y las tres fases están protegidas en condiciones de funcionamiento monofásico. 3. Connect field wiring to ground. / Conecte el cableado de campo a tierra. 4. Low voltage circuit to be NEC Class 2 with a Class 2 transformer 24Vdt, 50 or 60 hertz. / El circuito de baja tensión cumple lo especificado en el NEC. Código nacional eléctrico por americano para clase 2 y está provisto de un transformador clase 2 de 24V, 50 o 60 Hz. 5. Voltage control wiring. / Si necesita información sobre la base de conexión del terminalizado, consulte los esquemas del sistema o los esquemas del cableado de control de baja tensión de la sección interior.
<p style="text-align: center;">COMPONENT CODE CÓDIGO DE LOS COMPONENTES</p> <p>CC Compressor/Compresor CCH Compressor/Compresor GND Ground/Chasis/Tierra del chasis HPC High pressure cutout control/Control de interrupción por alta presión LAC Low ambient cooling control/Control de límite de temperatura LPC Low pressure cutout control/Control de interrupción por baja presión OPN Outdoor fan motor/Motor del ventilador exterior OFT On fan timer/Reloj de tiempo de funcionamiento RC Run capacitor/Capacitor de marcha RES Resistor/Resistor SR Start relay/Relé de arranque TB Terminal block/Bloque de terminales TDC Time delay control/Control de tiempo de retardo</p>	<p style="text-align: center;">WIRING INFORMATION INFORMACIÓN SOBRE EL CABLEADO</p> <p>Use the following information when wiring the ECM motor: - Factory standard / Estándar de fábrica - Factory option / Opción de fábrica - Field wiring / Instalación en el lugar - Factory standard / Estándar de fábrica - Factory option / Opción de fábrica Replacement Wire / Reemplazo de conductores Warning / Advertencia - The conductors must be of the same size and type of insulation as original (105°C min.). - Los conductores deben ser de la misma medida y tipo de aislamiento que el original. - Cabinet must be permanently grounded and conform to IEC, N.E.C., C.E.C. - El gabinete debe estar conectado a tierra de forma permanente y de acuerdo a la norma I.E.C (Europa), N.E.C (E.U.), C.E.C. (Canadá) y los códigos locales que sean de aplicación.</p>	<p style="text-align: center;">WIRE COLOR CODE CÓDIGO DE COLORES DEL CABLEADO</p> <p>BK BLACK / NEGRO OR ORANGE / NARANJA BL BLUE / AZUL R RED / ROJO G GREEN / VERDE GY GRAY / GRIS W WHITE / BLANCO Y YELLOW / AMARILLO</p> <p style="text-align: center;">WIRING DIAGRAM DIAGRAMA ELÉCTRICO DE CABLEADO</p> <p>REMOTHE HEAT PUMP 3 PHASE BOMBA DE CALOR REMOTA, TRIPLE FASE ECM MOTOR</p>
<p>DR. BY: JHB IPEP: BT INC.: 90-101229-32 REV: 02 10.17.14</p>		

11.0 WIRING DIAGRAMS

11.5 460V 3-Phase with PSC Motor

<p>WIRING SCHEMATIC ESQUEMA DE CABLEADO</p>	<p>COMPONENT CODE CÓDIGO DE LOS COMPONENTES</p> <p>COMP Compressor/Compresor GND Ground/Ground HPC High Pressure cut-out control/Control de interrupción por alta presión LAC Refrigeration liquid control/Control de límite de refrigeración líquida LPC Low pressure cut-out control/Control de interrupción de baja presión OFM Optional Fan Motor/Motor del ventilador exterior OPT Optional RES Resistor/Resistor SC Start capacitor/Capacitor de arranque TR Thermal protector/Protector térmico TDC Time delay control/Control del tiempo de retardo</p>	<p>NOTES OBSERVACIONES</p> <ol style="list-style-type: none"> Connectors suitable for use with copper conductors only. / Los conectores se pueden usar con conductores de cobre. Compressor Motor thermally protected and all 3 phase are protected under primary single phase conditions. / El motor del compresor posee protección térmica y las tres fases están protegidas en condiciones de fase simple. Correct field wiring in grounded (nights) conduit to avoid disconnect, disconnect voltage and phase per rating plate. / Escriba la instalación con tubería estanca para uso eléctrico en un conducto de noche (nights) para evitar desconectar, desconectar voltaje y fase por la placa de especificaciones. Frequency and quantity of field wires shall be as specified on the label of the equipment. / La frecuencia y cantidad de cables de campo deben cumplir lo indicado en la placa de especificaciones del equipo. Class 2, with Class 2 Insulation. / Clase 2, con Clase 2 Insulación. El cableado de baja tensión cumple lo especificado en el NEC. / El código nacional eléctrico norteamericano para clase 2, esta provisto de un transformador clase 2 de 24V, 30 o de 48V. Use the correct wiring for the equipment. / Use el cableado correcto para el equipo. Consulte los esquemas del sistema o los esquemas del cableado de control de baja tensión de la sección interior. 	<p>WIRING DIAGRAM DIAGRAMA DE CABLEADO</p>	<p>WIRE COLOR CODE CÓDIGO DE COLORES DEL CABLEADO</p> <p>BK. BLACK/NEGRO BR. BROWN/MARRON G. GREEN/VERDE GT. GRAY/GRIS O. ORANGE/NARANJA PK. PURPLE/VIOLETA W. WHITE/BLANCO Y. YELLOW/AMARILLO</p> <p>WIRING DIAGRAM DIAGRAMA ELÉCTRICO DE CABLEADO</p> <p>REMOTE HEAT PUMP, 3 PHASE BOMBA DE CALOR REMOTA, TRIPLE FASE</p>	<p>WIRING INFORMATION INFORMACIÓN SOBRE EL CABLEADO</p> <p>Use voltage / Usar voltaje Factory option / Opción de fábrica Field installed / Instalación en el lugar Factory standard / Estándar de fábrica Factory option / Opción de fábrica Replacement Wire / Reemplazo de conductores Must be the same size and type of insulation as original (105°C min.) Wiring / Advertencia The cabinet shall be connected to ground in accordance with the applicable code. El gabinete debe estar conectado a tierra de forma permanente y de acuerdo al código aplicable.</p>	<p>DR. BY: JHB DATE: 07-28-10 DWG. NO.: 90-101229-25 REV: 01</p>
--	--	--	---	---	---	--



